

LTC3310S

5V, Multiphase (40A, 30A, 20A), Synchronous Step-Down Silent Switcher 2

DESCRIPTION

Demonstration Circuit DC2874A shows the **LTC®3310S** 10A, Low Voltage, Synchronous Step-Down Silent Switcher operating as a multiphase 2.0MHz, 3.3V to 1.2V buck regulator. The DC2874A has three build options to provide a two phase 20A, three phase 30A, or four phase 40A output solution. The LTC3310S supports adjustable output voltages from 0.5V to V_{IN} and operating frequencies from 500kHz up to 2.25MHz in multiphase operation.

DC2874A operates in pulse skip mode and allows the slave phases to stop switching first before the master starts skipping pulses for better low current efficiency.

The DC2874A also has an EMI filter to reduce conducted EMI. This EMI filter can be included by applying the input

voltage at the VIN EMI terminal. The EMI performance of the board is shown in the EMI TEST RESULTS section. The red lines in the EMI performance graphs illustrate the CISPR25 Class 5 peak limits for the conducted and radiated emission tests.

The Efficiency vs. Load graph shows the efficiency of the circuit with a 3.3V input for the 2-, 3-, 4-phase circuits.

The LTC3310S datasheet gives a complete description of the device, operation and application information. The data sheet must be read in conjunction with this demo manual. The LTC3310S is assembled in a 3mm x 3mm LQFN package with exposed pads for low thermal resistance.

Design files for this circuit board are available.

All registered trademarks and trademarks are the property of their respective owners.

PERFORMANCE SUMMARY

Specifications are at $T_A = 25^\circ\text{C}$

SYMBOL	PARAMETER	CONDITIONS	MIN	TYP	MAX	UNITS
$V_{IN}/V_{IN\ EMI}$	DC2874A Input Voltage Range		2.25		5.5	V
V_{OUT}	DC2874A V_{OUT} Voltage Range*		1.176	1.2	1.224	V
I_{OUT}	DC2874A Output Current	-A, 4 phase build option -B, 3 phase build option -C, 2 phase build option			40 30 20	A A A
f_{SW}	Switching Frequency	V_{IN} greater than V_{OUT}	1.8	2	2.2	MHz
	Efficiency	2, 3, or 4 phase		92.5		%

*With 1% resistors. Accuracy will improve to within 1% using 0.1% resistors.

BOARD PHOTO

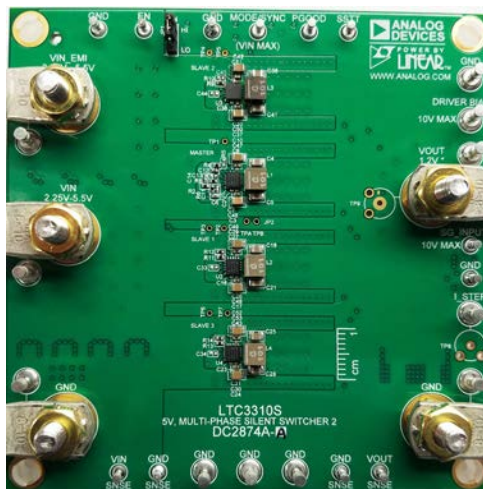

DEMO MANUAL DC2874A-A/ DC2874A-B/DC2874A-C

TYPICAL APPLICATION

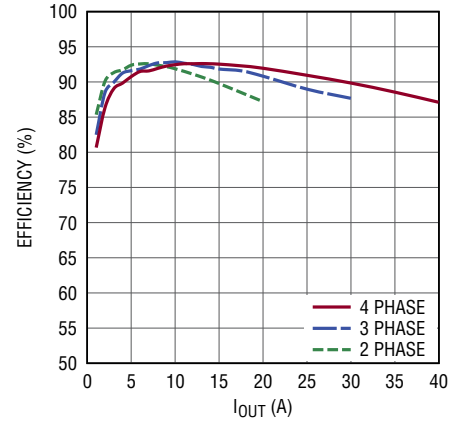
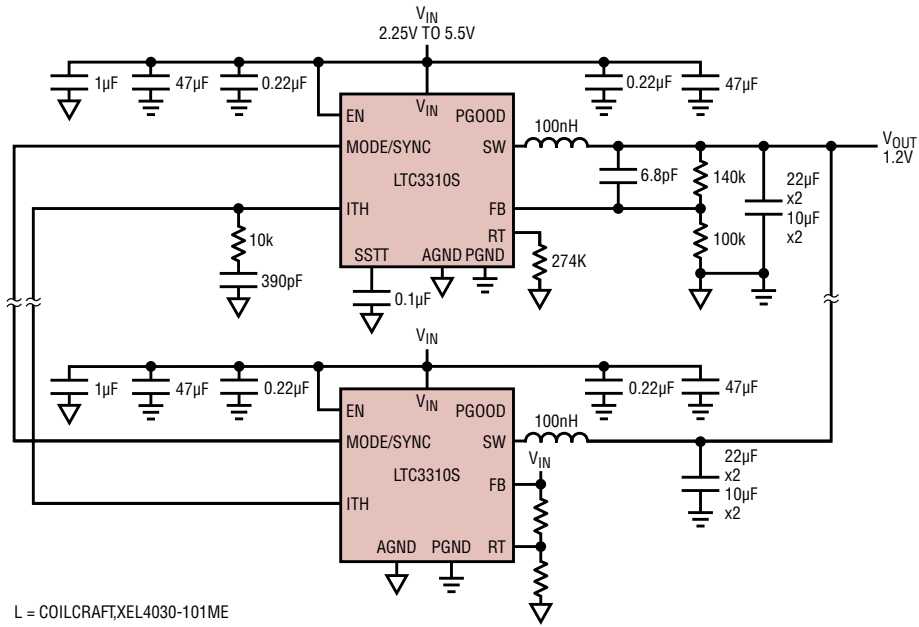

L = COILCRAFTXEL4030-101ME

Conducted EMI Performance
(CISPR25 Conducted Emission Test with Class 5 Peak Limits)

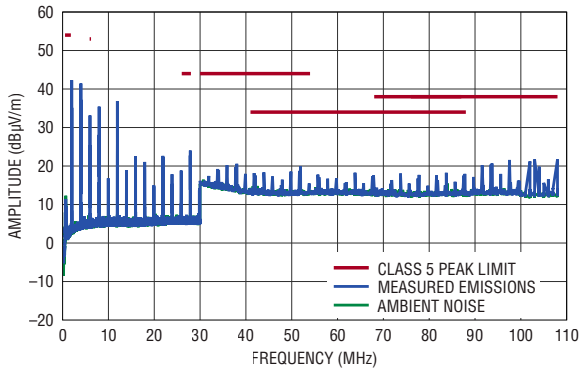

DC2874A-A 4-PHASE DEMO BOARD
(WITH EMI FILTER INSTALLED)
3.3V INPUT TO 1.2V OUTPUT AT 32A, $f_{SW} = 2\text{MHz}$

Radiated EMI Performance
(CISPR25 Radiated Emission Test with Class 5 Peak Limits)

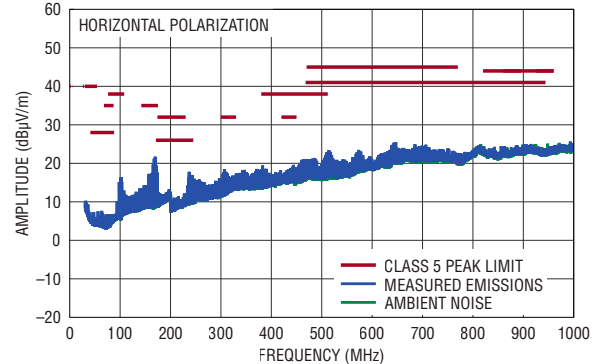

DC2874A-A 4-PHASE DEMO BOARD
(WITH EMI FILTER INSTALLED)
3.3V INPUT TO 1.2V OUTPUT AT 32A, $f_{SW} = 2\text{MHz}$

Radiated EMI Performance
(CISPR25 Radiated Emission Test with Class 5 Peak Limits)

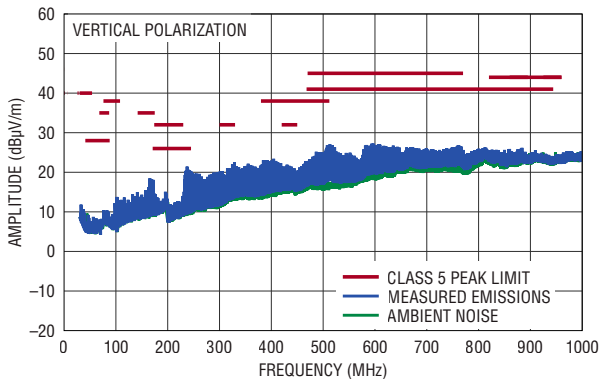

DC2874A-A 4-PHASE DEMO BOARD
(WITH EMI FILTER INSTALLED)
3.3V INPUT TO 1.2V OUTPUT AT 32A, $f_{SW} = 2\text{MHz}$

VOUT Ripple
($I_{OUT} = 40\text{A}$)

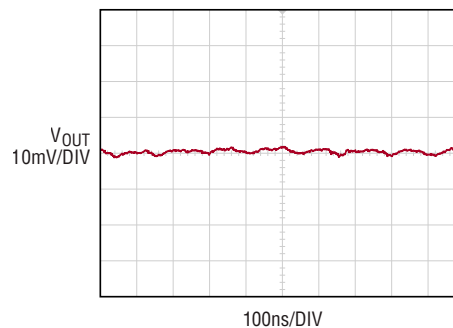

QUICK START PROCEDURE

Demonstration circuit 2874A is easy to set up and evaluate the performance of the LTC3310S in multiphase operation. Refer to Figure 1 for the proper measurement equipment setup and jumper settings. Follow the procedure below to familiarize yourself with the DC2874A.

NOTE: For accurate V_{IN} , V_{OUT} and efficiency measurements, measure V_{IN} at the VIN SNSE and GND SNSE turrets and V_{OUT} at the VOUT SNSE and GND SNSE turrets as illustrated as VM1 and VM2 in Figure 1. When measuring the input or output voltage ripple, care must be taken to avoid a long ground lead on the oscilloscope probe. Measure the output voltage ripple by touching the probe tip directly across the output turrets or to TP1 as shown in Figure 2.

1. Set the JP1 Jumper to the HI position.
2. With power off, connect the input power supply to VIN and GND. If the input EMI filter is desired, connect the input power supply to VIN EMI and GND.
3. Slowly increase PS1 to 1.0V. If AM1 reads less than 20mA, increase PS1 to 3.3V. Verify that VM1 reads 3.3V and VM2 reads 1.2V. Record VM1, VM2, VM3 AM1 and AM2. Connect an oscilloscope voltage probe as shown in Figure 2. Set Channel to AC coupled, voltage scale to 10mV and time base to 100ns. Record V_{OUT} ripple voltage. Verify that PGOOD voltage is above 3V. Set the EN Jumper, JP1, to the HI position.
4. Increase the load by 1A intervals up to full load and observe the voltage output regulation, ripple voltage.
5. To test the transient response with a base load, turn off LD1 and add the desired resistor to produce a minimum load between VOUT and I_STEP turrets (RL shown on Figure 1).

Note that the total load resistance will be RL plus the parallel combination of R16 and R18 (10m Ω).

The DC2874A uses a buffered signal generator input to drive a source follower circuit and control the slew rate and amplitude of the current transient. The source follower FET, Q1, is operated in the linear region during the load step. The current step is measured as the voltage across the parallel combination of R16 and R18 (10m Ω), V_{I_STEP} .

6. Connect PS2 to the DRIVER BIAS and GND turrets. Turn on and set PS2 to 8V.
7. Measure the I_STEP voltage to observe the current, $V_{I_STEP}/10m\Omega$. Adjust the amplitude of the pulse to provide the desired transient. Adjust the rising and falling edge of the pulse to provide the desired ramp rate. Figure 3 shows a load step from 8A (RL = 150m Ω) to 36A. Refer to the following equations:

$$I_{OUT} = \frac{V_{I_STEP}}{10m\Omega} \quad (1)$$

Where:

$$V_{I_STEP} = V_{SG_INPUT} - V_{GS} \quad (2)$$

8. Set a signal generator with a 1ms pulse width, a 10ms period and an amplitude from 0V to 3V, and then connect it to the SG_INPUT turret.

NOTE: Do not allow the pulse generator to have more than a 20% duty cycle. This can allow too much power to be dissipated in Q1 and can damage the FET.

9. Connect an oscilloscope with a horizontal scale of 200us/Div with one channel having a vertical scale of 2V/Div on the SG_INPUT and another with a vertical scale of 50mV/Div to the I_STEP turret.
10. Adjust the amplitude of the SG_INPUT pulse to obtain the desired load pulse observed on the I_STEP turret.
11. Turn off PS1, PS2 and the signal generator. Remove all connections from demo board.

DEMO MANUAL DC2874A-A/ DC2874A-B/DC2874A-C

QUICK START PROCEDURE

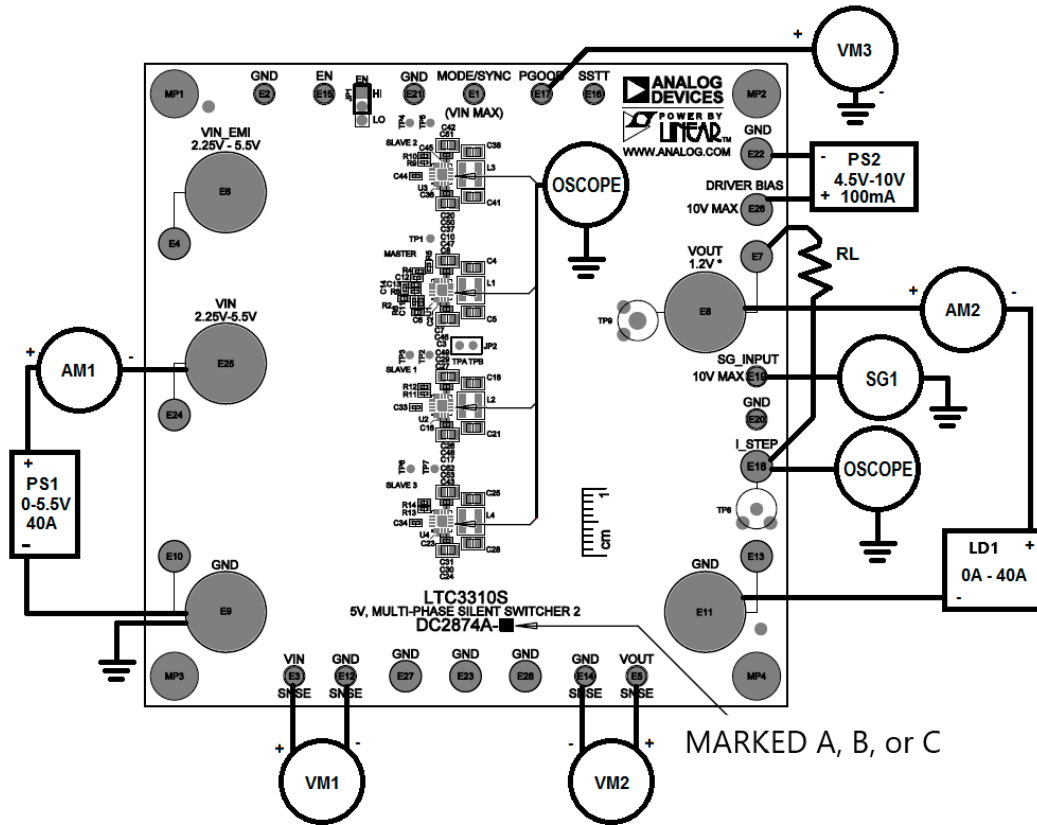

Figure 1. Test Setup for the DC2874A Demo Board

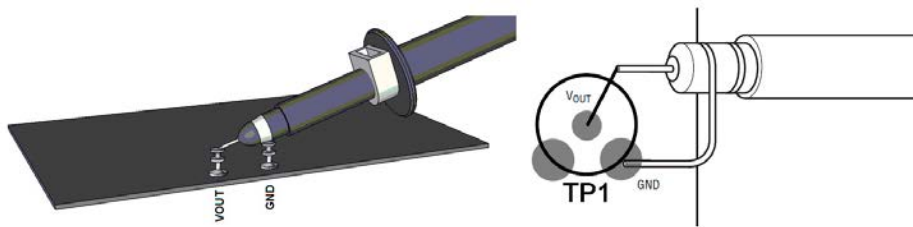

Figure 2. Technique for Measuring Output Ripple and Step Response

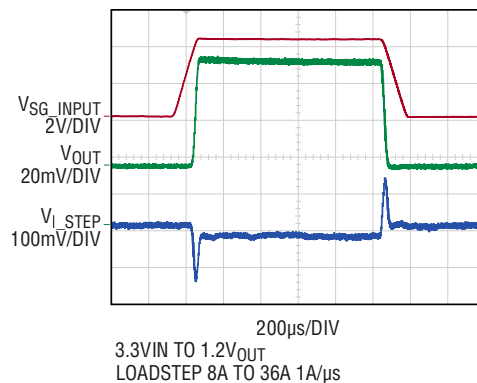

Figure 3. DC2874A-A 4-Phase Load Transient Response

THEORY OF OPERATION

Introduction to the DC2874A

The DC2874A demonstration circuit features the LTC3310S, a Low Voltage Synchronous Step-Down Silent Switcher in two, three, or four phase operation. The LTC3310S is a monolithic, constant frequency, current mode step-down DC/DC converter. Connecting the RT pin of the master phase, to a resistor to AGND programs the frequency from 500kHz to 2.25MHz and configures the MODE/SYNC pin to become clock output used to drive the MODE/SYNC pin of the slave phase(s). The DC2874A can operate with an external clock by shorting the master phase RT pin to V_{IN} by placing a 0Ω resistor in the R5 location and applying a sync pulse on the MODE/SYNC turret.

Connecting the FB pin to V_{IN} configures a phase as a slave. The MODE/SYNC becomes an input and the voltage control loop is disabled. The slave phase current control loop is still active and the peak current is controlled via the shared ITH node. The phasing of a slave phase relative to the master phase is programmed with a resistor divider on the RT pin. Refer to Table 5 of the LTC3310S datasheet for more information on setting the slave phase angle.

In the multiphase application the LTC3310S operate in pulse skip mode. At light loads, the slave phases will start pulse skipping before the master phase and can eventually stop switching as the load continues to decrease. The ability to allow the slave phases to stop switching at light loads reduces I_q current and switching losses at light loads.

Setting the compensation for the multiphase is similar to setting the compensation to a single phase. When determining the compensation components, C11, C14 and R8, controlling the loop stability and transient response are the two main considerations. The LTC3310S has been

designed to operate at a high bandwidth for fast transient response capabilities. This reduces output capacitance required to meet the desired transient voltage range. The mid-band gain of the loop increases with R8 and the bandwidth of the loop increases with decreasing C14. C11 along with R6 provides a phase lead which will improve the phase margin. C13, C33, C34, and C44 along with R12 provides a high frequency pole to reduce the high frequency gain. C13, C33, C34, and C44 are in parallel on the ITH node. The sum of these caps will be the total capacitance on the Master phase ITH pin. Too much capacitance can slow down the response time.

Loop stability is generally measured using the Bode Plot method of plotting loop gain in dB and phase shift in degrees. The 0dB crossover frequency should be less than 1/6 of the operating frequency to reduce the effects of added phase shift of the modulator. The control loop phase margin goal should be 45° or greater and a gain margin goal of 8dB or greater. Refer to the LTC3310S datasheet and [LTPowerCAD](#) for more information on choosing the required components.

The softstart of the multiphase regulator is controlled by a single cap, C12, on the master phase. After the regulator is in regulation the SSTT pin can be used to monitor the temperature of each IC. The master phase temperature can be monitored at the SSTT turret and slave 1, 2, and 3 can be monitored at TP3, 4, and 6 respectively. Calculate the die temperature with the formula below:

$$T_J(^{\circ}\text{C}) = \frac{V_{\text{SSTT}}}{4\text{mV}} - 273 \quad (3)$$

DEMO MANUAL DC2874A-A/ DC2874A-B/DC2874A-C

PARTS LIST (DEMO BOARD DC2874A-A)

ITEM	QTY	REFERENCE	PART DESCRIPTION	MANUFACTURER/PART NUMBER
Required Circuit Components				
1	4	C2, C16, C23, C36	CAP., 1uF, X6S, 6.3V, 20%, 0201	MURATA, GRM033C80J105ME05D
2	8	C3, C10, C17, C24, C37, C42, C49, C52	CAP., 47uF, X5R, 10V, 20%, 0805	MURATA, GRM21BR61A476ME15L
3	8	C4, C5, C18, C21, C25, C28, C38, C41	CAP., 22uF, X5R, 25V, 20%, 0805	SAMSUNG, CL21A226MAQNNNE
4	1	C11	CAP., 6.8pF, COG/NPO, 50V, +/-0.5pF, 0402	AVX, 04025A6R8DAT2A
5	1	C12	CAP., 0.1uF, X5R, 25V, 10%, 0402	SAMSUNG, CL05A104KA5NNNC
6	1	C14	CAP., 390pF, COG, 50V, 5%, 0402	AVX, 04025A391JAT2A
7	8	C29, C30, C46-C48, C50, C51, C53	CAP., 0.47uF, X7S, 10V, 10%, 0402	MURATA, GCM155C71A474KE36D
8	4	L1-L4	IND., 0.1uH, PWR, SHIELDED, 20%, 25.8A, 1.8mOhms, 4.3x4.3mm, XEL4030, AEC-Q200	COILCRAFT, XEL4030-101MEB
9	3	R2, R11, R14	RES., 100k OHMS, 1%, 1/16W, 0402, AEC-Q200	VISHAY, CRCW0402100KFKED
10	1	R4	RES., 274k OHMS, 1%, 1/16W, 0402, AEC-Q200	VISHAY, CRCW0402274KFKED
11	1	R6	RES., 140k OHMS, 1%, 1/16W, 0402, AEC-Q200	VISHAY, CRCW0402140KFKED
12	1	R8	RES., 10k OHMS, 1%, 1/16W, 0402	VISHAY, CRCW040210K0FKEDC
13	2	R12, R13	RES., 301k OHMS, 1%, 1/16W, 0402	VISHAY, CRCW0402301KFKEDC
14	4	U1-U4	IC, Low Voltage Syn. Step-Down Reg, LQFN-18	ANALOG DEVICES, LTC3310SEV#PBF
Additional Demo Board Circuit Components				
1	6	C1, C15, C39, C60, C64, C68	CAP., 470uF, TANT. POSCAP, 6.3V, 20%, 7343, 18mOHMS, TPE	PANASONIC, 6TPE470MI
2	7	C6, C9, C32, C54, C57, C61, C65	CAP., 0.1uF, X5R, 25V, 10%, 0402	SAMSUNG, CL05A104KA5NNNC
3	8	C7, C8, C20, C26, C27, C31, C43, C45	CAP., 0.01uF, X7R, 6.3V, 10%, 0201	MURATA, GRM033R70J103KA01D
4	1	C19	CAP., 22uF, X5R, 25V, 20%, 0805	SAMSUNG, CL21A226MAQNNNE
5	0	C22	CAPACITOR, OPT, 3-PIN 0402, FILTER/BYPASS	
6	8	C55, C56, C58, C59, C62, C63, C66, C67	CAP., 10uF, X5R, 10V, 20%, 0603	SAMSUNG, CL10A106MP8NNNC
7	4	L5-L8	IND., 100 OHMS@100MHz, FERRITE BEAD, 25%, 8A, 6mOHMS, 1812	WURTH ELEKTRONIK, 74279226101
8	1	Q1	XSTR., MOSFET, N-CH, 60V, 120A, TO-263	VISHAY, SUM50020E-GE3
9	1	R1	RES., 1M OHMS, 1%, 1/16W, 0402, AEC-Q200	VISHAY, CRCW04021M00FKED
10	1	R3	RES., 249k OHMS, 1%, 1/16W, 0402, AEC-Q200	VISHAY, CRCW0402249KFKED
11	1	R7	RES., 100k OHMS, 5%, 1/16W, 0402, AEC-Q200	VISHAY, CRCW0402100KJNED
12	1	R9	RES., 0 OHM, 1/16W, 0402, AEC-Q200	VISHAY, CRCW04020000Z0ED
13	2	R16, R18	RES., 0.02 OHM, 1%, 10W, 2828, PWR, METAL, SENSE, AEC-Q200	VISHAY, WSHW2818R0200FEA
14	1	R17	RES., 10k OHMS, 5%, 1/16W, 0402, AEC-Q200	VISHAY, CRCW040210K0JNED
15	1	R19	RES., 51 OHMS, 5%, 1/16W, 0402	VISHAY, CRCW040251R0JNED

DEMO MANUAL DC2874A-A/ DC2874A-B/DC2874A-C

PARTS LIST (DEMO BOARD DC2874A-A)

ITEM	QTY	REFERENCE	PART DESCRIPTION	MANUFACTURER/PART NUMBER
16	1	RG1	RES., 20 OHMS, 1%, 1/16W, 0402, AEC-Q200	VISHAY, CRCW040220R0FKED
17	1	U5	IC OPAMP BUFFER 20MHZ 8DFN	ANALOG DEVICES, LT1010CDD#PBF

Hardware: For Demo Board Only

1	12	E1-E3, E5, E12, E14-E17, E19-E21	TEST POINT, TURRET, 0.064" MTG. HOLE, PCB 0.062" THK	MILL-MAX, 2308-2-00-80-00-00-07-0
2	11	E4, E7, E10, E13, E18, E22-E24, E26-E28	TEST POINT, TURRET, 0.094" MTG. HOLE, PCB 0.062" THK	MILL-MAX, 2501-2-00-80-00-00-07-0
3	5	E6, E8, E9, E11, E25	STUD, #10-32, FASTENER, 0.625" LENGTH	PENCOM, PR1422
4	1	JP1	CONN., HDR, MALE, 1x3, 2mm, VERT, STR, THT	WURTH ELEKTRONIK, 62000311121
5	4	MP1-MP4	STANDOFF, NYLON, SNAP-ON, 0.25" (6.4mm)	KEYSTONE, 8831
6	5	MP5-MP9	CONN RING FLAT 8AWG #10 CRIMP	MOLEX, 0192210223
7	10	MP10-MP19	NUT, HEX, #10-32, BRASS	PENCOM, NU1132
8	5	MP20-MP24	WASHER, #10, LOCK, EXT, TIN FINISH	PENCOM, WA4526
9	1	XJP1	CONN., SHUNT, FEMALE, 2 POS, 2mm	WURTH ELEKTRONIK, 60800213421

DEMO MANUAL DC2874A-A/ DC2874A-B/DC2874A-C

PARTS LIST (DEMO BOARD DC2874A-B)

ITEM	QTY	REFERENCE	PART DESCRIPTION	MANUFACTURER/PART NUMBER
Required Circuit Components				
1	3	C2, C16, C36	CAP., 1uF, X6S, 6.3V, 20%, 0201	MURATA, GRM033C80J105ME05D
2	6	C3, C10, C17, C37, C42, C49	CAP., 47uF, X5R, 10V, 20%, 0805	MURATA, GRM21BR61A476ME15L
3	6	C4, C5, C18, C21, C38, C41	CAP., 22uF, X5R, 25V, 20%, 0805	SAMSUNG, CL21A226MAQNNNE
4	1	C11	CAP., 6.8pF, COG/NPO, 50V, +/-0.5pF, 0402	AVX, 04025A6R8DAT2A
5	1	C12	CAP., 0.1uF, X5R, 25V, 10%, 0402	SAMSUNG, CL05A104KA5NNNC
6	1	C14	CAP., 390pF, COG, 50V, 5%, 0402	AVX, 04025A391JAT2A
7	6	C29, C46-C48, C50, C51	CAP., 0.47uF, X7S, 10V, 10%, 0402	MURATA, GCM155C71A474KE36D
8	3	L1-L3	IND., 0.1uH, PWR, SHIELDED, 20%, 25.8A, 1.8mOhms, 4.3x4.3mm, XEL4030, AEC-Q200	COILCRAFT, XEL4030-101MEB
9	1	L8	IND., 100 OHMS@100MHz, FERRITE BEAD, 25%, 8A, 6mOHMS, 1812	WURTH ELEKTRONIK, 74279226101
10	1	R2	RES., 100k OHMS, 1%, 1/16W, 0402, AEC-Q200	VISHAY, CRCW0402100KFKED
11	1	R4	RES., 274k OHMS, 1%, 1/16W, 0402, AEC-Q200	VISHAY, CRCW0402274KFKED
12	1	R6	RES., 140k OHMS, 1%, 1/16W, 0402, AEC-Q200	VISHAY, CRCW0402140KFKED
13	1	R8	RES., 10k OHMS, 1%, 1/16W, 0402	VISHAY, CRCW040210K0FKEDC
14	2	R9, R12	RES., 243k OHMS, 1%, 1/16W, 0402, AEC-Q200	VISHAY, CRCW0402243KFKED
15	2	R10, R11	RES., 174k OHMS, 1%, 1/16W, 0402, AEC-Q200	VISHAY, CRCW0402174KFKED
16	3	U1-U3	IC, Low Voltage Syn. Step-Down Reg, LQFN-18	ANALOG DEVICES, LTC3310SEV#PBF
Additional Demo Board Circuit Components				
1	6	C6, C9, C32, C57, C61, C65	CAP., 0.1uF, X5R, 25V, 10%, 0402	SAMSUNG, CL05A104KA5NNNC
2	6	C7, C8, C20, C26, C27, C45	CAP., 0.01uF, X7R, 6.3V, 10%, 0201	MURATA, GRM033R70J103KA01D
3	5	C15, C39, C60, C64, C68	CAP., 470uF, TANT. POSCAP, 6.3V, 20%, 7343, 18mOHMS, TPE	PANASONIC, 6TPE470MI
4	1	C19	CAP., 22uF, X5R, 25V, 20%, 0805	SAMSUNG, CL21A226MAQNNNE
5	0	C22	CAPACITOR, OPT, 3-PIN 0402, FILTER/BYPASS	
6	6	C58, C59, C62, C63, C66, C67	CAP., 10uF, X5R, 10V, 20%, 0603	SAMSUNG, CL10A106MP8NNNC
7	2	L6, L7	IND., 100 OHMS@100MHz, FERRITE BEAD, 25%, 8A, 6mOHMS, 1812	WURTH ELEKTRONIK, 74279226101
8	5	MP5-MP9	CONN RING FLAT 8AWG #10 CRIMP	MOLEX, 0192210223
9	1	Q1	XSTR., MOSFET, N-CH, 60V, 120A, TO-263	VISHAY, SUM50020E-GE3
10	1	R1	RES., 1M OHMS, 1%, 1/16W, 0402, AEC-Q200	VISHAY, CRCW04021M00FKED
11	1	R3	RES., 249k OHMS, 1%, 1/16W, 0402, AEC-Q200	VISHAY, CRCW0402249KFKED
12	1	R7	RES., 100k OHMS, 5%, 1/16W, 0402, AEC-Q200	VISHAY, CRCW0402100KJNED
13	2	R16, R18	RES., 0.02 OHM, 1%, 10W, 2828, PWR, METAL, SENSE, AEC-Q200	VISHAY, WSHP2818R0200FEA

DEMO MANUAL DC2874A-A/ DC2874A-B/DC2874A-C

PARTS LIST (DEMO BOARD DC2874A-B)

ITEM	QTY	REFERENCE	PART DESCRIPTION	MANUFACTURER/PART NUMBER
14	1	R17	RES., 10k OHMS, 5%, 1/16W, 0402, AEC-Q200	VISHAY, CRCW040210K0JNED
15	1	R19	RES., 51 OHMS, 5%, 1/16W, 0402	VISHAY, CRCW040251R0JNED
16	1	RG1	RES., 20 OHMS, 1%, 1/16W, 0402, AEC-Q200	VISHAY, CRCW040220R0FKED
17	1	U5	IC OPAMP BUFFER 20MHZ 8DFN	ANALOG DEVICES, LT1010CDD#PBF

Hardware: For Demo Board Only

1	12	E1-E3, E5, E12, E14-E17, E19-E21	TEST POINT, TURRET, 0.064" MTG. HOLE, PCB 0.062" THK	MILL-MAX, 2308-2-00-80-00-00-07-0
2	11	E4, E7, E10, E13, E18, E22-E24, E26-E28	TEST POINT, TURRET, 0.094" MTG. HOLE, PCB 0.062" THK	MILL-MAX, 2501-2-00-80-00-00-07-0
3	5	E6, E8, E9, E11, E25	STUD, #10-32, FASTENER, 0.625" LENGTH	PENCOM, PR1422
4	1	JP1	CONN., HDR, MALE, 1x3, 2mm, VERT, STR, THT	WURTH ELEKTRONIK, 62000311121
5	4	MP1-MP4	STANDOFF, NYLON, SNAP-ON, 0.25" (6.4mm)	KEYSTONE, 8831
6	10	MP10-MP19	NUT, HEX, #10-32, BRASS	PENCOM, NU1132
7	5	MP20-MP24	WASHER, #10, LOCK, EXT, TIN FINISH	PENCOM, WA4526
8	1	XJP1	CONN., SHUNT, FEMALE, 2 POS, 2mm	WURTH ELEKTRONIK, 60800213421

DEMO MANUAL DC2874A-A/ DC2874A-B/DC2874A-C

PARTS LIST (DEMO BOARD DC2874A-C)

ITEM	QTY	REFERENCE	PART DESCRIPTION	MANUFACTURER/PART NUMBER
Required Circuit Components				
1	2	C2, C16	CAP, 1uF, X6S, 6.3V, 20%, 0201	MURATA, GRM033C80J105ME05D
2	4	C3, C10, C17, C49	CAP, 47uF, X5R, 10V, 20%, 0805	MURATA, GRM21BR61A476ME15L
3	4	C4, C5, C18, C21	CAP, 22uF, X5R, 25V, 20%, 0805	SAMSUNG, CL21A226MAQNNNE
4	1	C11	CAP, 6.8pF, COG/NPO, 50V, +/-0.5pF, 0402	AVX, 04025A6R8DAT2A
5	1	C12	CAP, 0.1uF, X5R, 25V, 10%, 0402	SAMSUNG, CL05A104KA5NNNC
6	1	C14	CAP, 390pF, COG, 50V, 5%, 0402	AVX, 04025A391JAT2A
7	4	C29, C46-C48	CAP, 0.47uF, X7S, 10V, 10%, 0402	MURATA, GCM155C71A474KE36D
8	2	L1, L2	IND., 0.1uH, PWR, SHIELDED, 20%, 25.8A, 1.8mOhms, 4.3x4.3mm, XEL4030, AEC-Q200	COILCRAFT, XEL4030-101MEB
9	1	L7	IND., 100 OHMS@100MHZ, FERRITE BEAD, 25%, 8A, 6mOHMS, 1812	WURTH ELEKTRONIK, 74279226101
10	1	R2	RES., 100k OHMS, 1%, 1/16W, 0402, AEC-Q200	VISHAY, CRCW0402100KFKED
11	1	R4	RES., 274k OHMS, 1%, 1/16W, 0402, AEC-Q200	VISHAY, CRCW0402274KFKED
12	1	R6	RES., 140k OHMS, 1%, 1/16W, 0402, AEC-Q200	VISHAY, CRCW0402140KFKED
13	1	R8	RES., 10k OHMS, 1%, 1/16W, 0402	VISHAY, CRCW040210K0FKEDC
14	2	U1, U2	IC, Low Voltage Syn. Step-Down Reg, LQFN-18	ANALOG DEVICES, LTC3310SEV#PBF
Additional Demo Board Circuit Components				
1	5	C6, C9, C32, C57, C61	CAP, 0.1uF, X5R, 25V, 10%, 0402	SAMSUNG, CL05A104KA5NNNC
2	4	C7, C8, C26, C27	CAP, 0.01uF, X7R, 6.3V, 10%, 0201	MURATA, GRM033R70J103KA01D
3	4	C15, C39, C60, C68	CAP, 470uF, TANT. POSCAP, 6.3V, 20%, 7343, 18mOHMS, TPE	PANASONIC, 6TPE470MI
4	1	C19	CAP, 22uF, X5R, 25V, 20%, 0805	SAMSUNG, CL21A226MAQNNNE
5	0	C22	CAPACITOR, OPT, 3-PIN 0402, FILTER/BYPASS	
6	4	C58, C59, C62, C63	CAP, 10uF, X5R, 10V, 20%, 0603	SAMSUNG, CL10A106MP8NNNC
7	1	L6	IND., 100 OHMS@100MHz, FERRITE BEAD, 25%, 8A, 6mOHMS, 1812	WURTH ELEKTRONIK, 74279226101
8	1	Q1	XSTR., MOSFET, N-CH, 60V, 120A, TO-263	VISHAY, SUM50020E-GE3
9	1	R1	RES., 1M OHMS, 1%, 1/16W, 0402, AEC-Q200	VISHAY, CRCW04021M00FKED
10	1	R3	RES., 249k OHMS, 1%, 1/16W, 0402, AEC-Q200	VISHAY, CRCW0402249KFKED
11	1	R7	RES., 100k OHMS, 5%, 1/16W, 0402, AEC-Q200	VISHAY, CRCW0402100KJNED
12	1	R11	RES., 0 OHM, 1/16W, 0402, AEC-Q200	NIC, NRC04ZOTRF
13	2	R16, R18	RES., 0.02 OHM, 1%, 10W, 2828, PWR, METAL, SENSE, AEC-Q200	VISHAY, WSH2818R0200FEA
14	1	R17	RES., 10k OHMS, 5%, 1/16W, 0402, AEC-Q200	VISHAY, CRCW040210K0JNED
15	1	R19	RES., 51 OHMS, 5%, 1/16W, 0402	VISHAY, CRCW040251R0JNED
16	1	RG1	RES., 20 OHMS, 1%, 1/16W, 0402, AEC-Q200	VISHAY, CRCW040220R0FKED
17	1	U5	IC OPAMP BUFFER 20MHZ 8DFN	ANALOG DEVICES, LT1010CDD#PBF

DEMO MANUAL DC2874A-A/ DC2874A-B/DC2874A-C

PARTS LIST (DEMO BOARD DC2874A-C)

ITEM	QTY	REFERENCE	PART DESCRIPTION	MANUFACTURER/PART NUMBER
Hardware: For Demo Board Only				
1	12	E1-E3, E5, E12, E14-E17, E19-E21	TEST POINT, TURRET, 0.064" MTG. HOLE, PCB 0.062" THK	MILL-MAX, 2308-2-00-80-00-00-07-0
2	11	E4, E7, E10, E13, E18, E22-E24, E26-E28	TEST POINT, TURRET, 0.094" MTG. HOLE, PCB 0.062" THK	MILL-MAX, 2501-2-00-80-00-00-07-0
3	5	E6, E8, E9, E11, E25	STUD, #10-32, FASTENER, 0.625" LENGTH	PENCOM, PR1422
4	1	JP1	CONN., HDR, MALE, 1x3, 2mm, VERT, STR, THT	WURTH ELEKTRONIK, 62000311121
5	4	MP1-MP4	STANDOFF, NYLON, SNAP-ON, 0.25" (6.4mm)	KEYSTONE, 8831
6	5	MP5-MP9	CONN RING FLAT 8AWG #10 CRIMP	MOLEX, 0192210223
7	10	MP10-MP19	NUT, HEX, #10-32, BRASS	PENCOM, NU1132
8	5	MP20-MP24	WASHER, #10, LOCK, EXT, TIN FINISH	PENCOM, WA4526
9	1	XJP1	CONN., SHUNT, FEMALE, 2 POS, 2mm	WURTH ELEKTRONIK, 60800213421

DEMO MANUAL DC2874A-A/ DC2874A-B/DC2874A-C

SCHEMATIC DIAGRAM

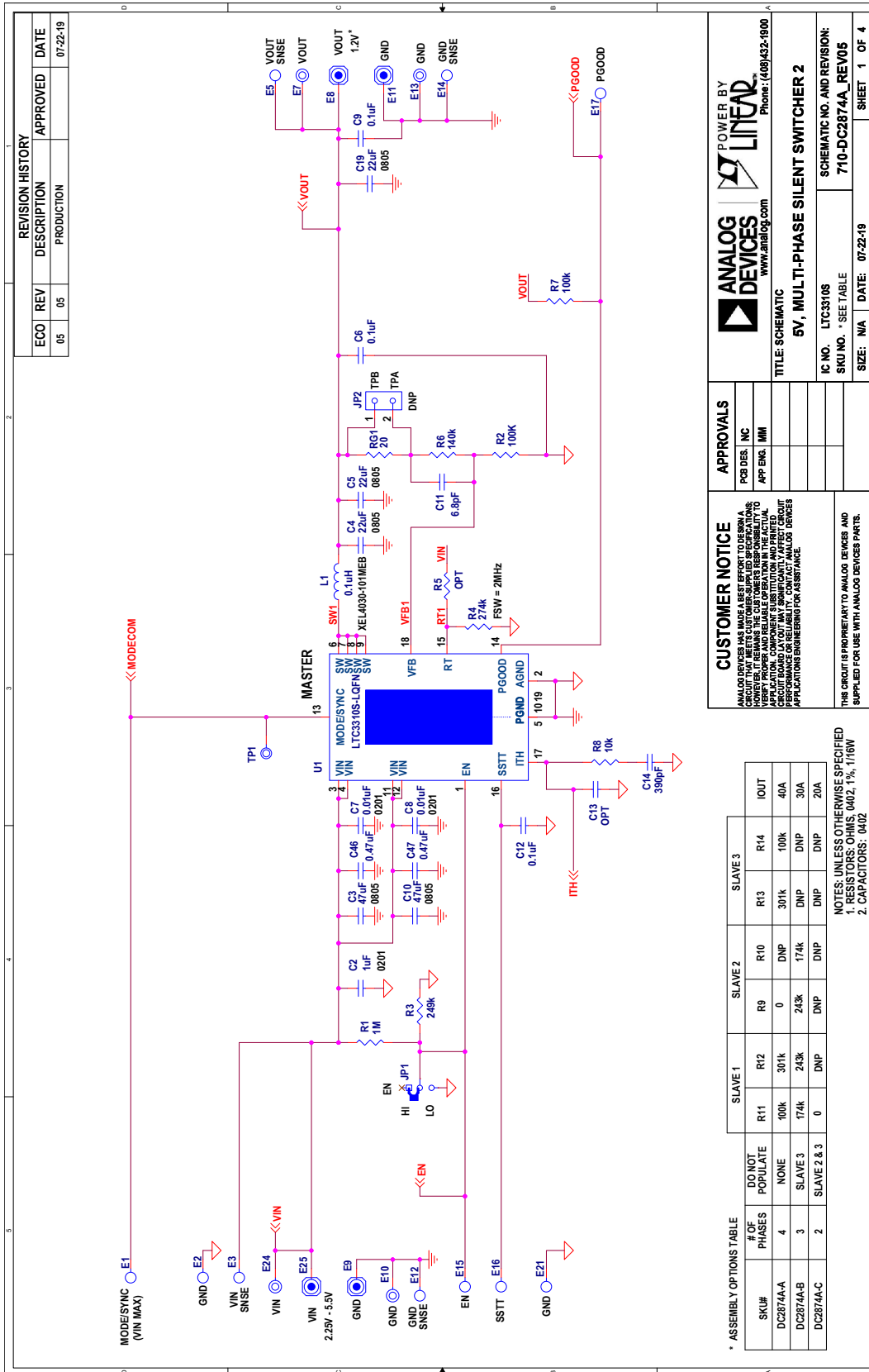

SCHEMATIC DIAGRAM

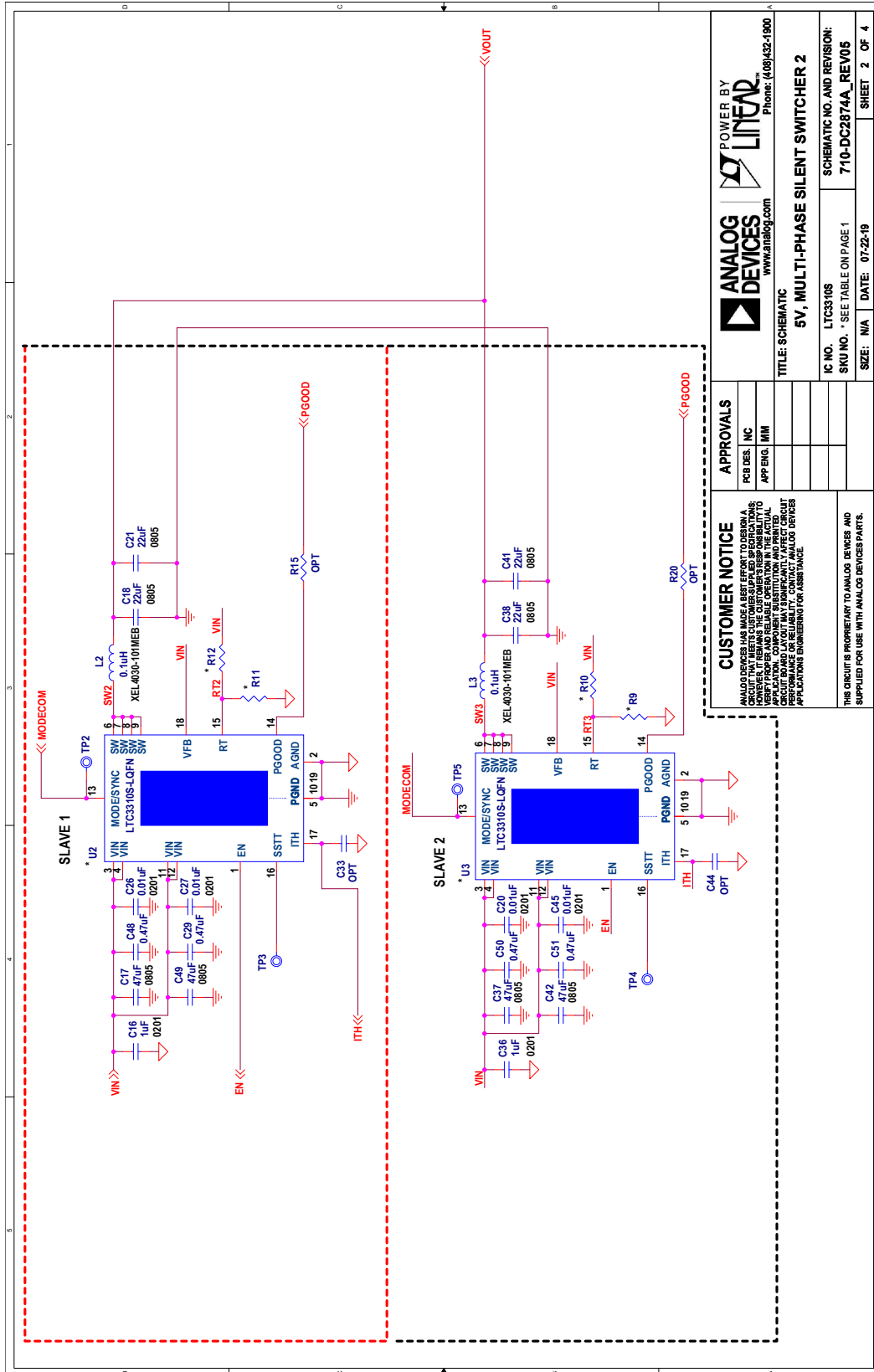

APPROVALS PCB DES. INC APPRNG. MIM		TITLE: SCHEMATIC 5V, MULTI-PHASE SILENT SWITCHER 2	
CUSTOMER NOTICE ANALOG DEVICES HAS MADE A BEST EFFORT TO DESIGN A DEMO BOARD. HOWEVER, IT REMAINS THE CUSTOMER'S RESPONSIBILITY TO VERIFY THE BOARD LAYOUT AND COMPONENTS AGAINST THE APPLICATION COMPONENTS LIST AND RELEVANT APPLICATION NOTES. COMPONENTS ARE NOT GUARANTEED TO BE AVAILABLE IN ALL REGIONS. ANALOG DEVICES APPLICATIONS ENGINEERING FOR ASSISTANCE.		IC NO. LTC3310S SKU NO. * SEE TABLE ON PAGE 1 SIZE: N/A DATE: 07-22-19	
THIS CIRCUIT IS PROPRIETARY TO ANALOG DEVICES AND SUPPLIED FOR USE WITH ANALOG DEVICES PARTS.		SCHEMATIC NO. AND REVISION: 710-DC2874A_REV05 SHEET 2 OF 4	

DEMO MANUAL DC2874A-A/ DC2874A-B/DC2874A-C

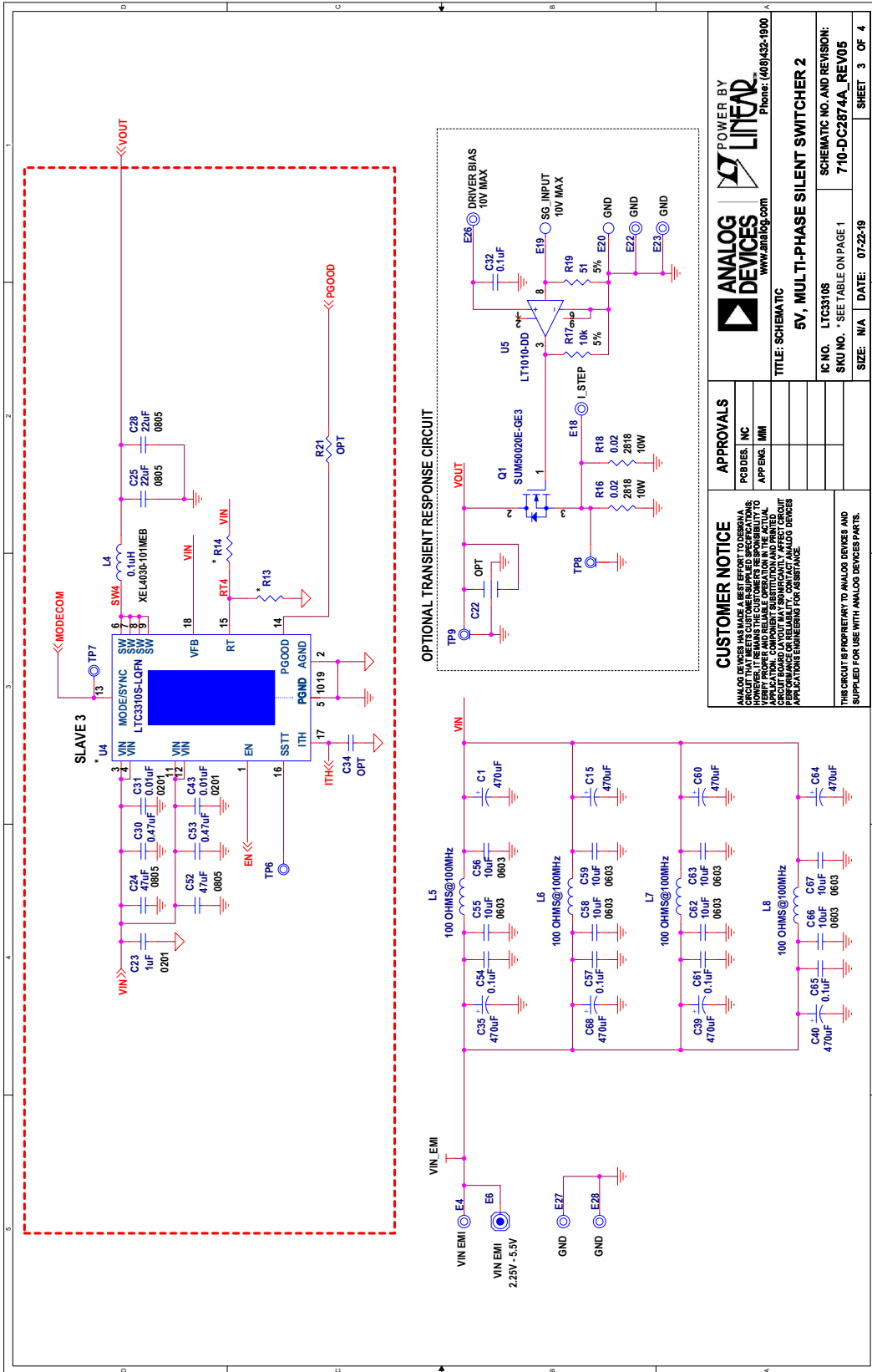

SCHEMATIC DIAGRAM



ANALOG DEVICES		POWER BY LINEAR	
WWW.ANALOGDEVICES.COM		PHONE: (409)432-1900	
TITLE: SCHEMATIC			
5V, MULTI-PHASE SILENT SWITCHER 2			
IC NO. LTC3310S		SCHEMATIC NO. AND REVISION:	
SKU NO. * SEE TABLE ON PAGE 1		710-DC2874A_REV05	
SIZE: N/A	DATE: 07-22-19	SHEET 3	OF 4
CUSTOMER NOTICE		APPROVALS	
ANALOG DEVICES HAS MADE A BEST EFFORT TO DESCRIBE THE INFORMATION CONTAINED HEREIN. HOWEVER, IT REMAINS THE CUSTOMER'S RESPONSIBILITY TO VERIFY THE INFORMATION CONTAINED HEREIN FOR THEIR APPLICATION. COMPONENT SUBSTITUTION AND PRINTED CIRCUIT BOARD LAYOUT MAY SIGNIFICANTLY AFFECT CIRCUIT PERFORMANCE. CONSULT AN ANALOG DEVICES APPLICATIONS ENGINEER FOR ASSISTANCE.		PCB DES: INC APP: EMM	
THIS CIRCUIT IS PROPRIETARY TO ANALOG DEVICES AND IS SUPPLIED FOR USE WITH ANALOG DEVICES PARTS.			

SCHEMATIC DIAGRAM

PCA ADDITIONAL PARTS	
MP1	STANDOFF,NYLON,SNAP-ON,0.25" (6.4mm)
MP2	STANDOFF,NYLON,SNAP-ON,0.25" (6.4mm)
MP3	STANDOFF,NYLON,SNAP-ON,0.25" (6.4mm)
MP4	STANDOFF,NYLON,SNAP-ON,0.25" (6.4mm)
LBI	BOARD SIN LABEL
PCB1	PCB, DC2874A REV05
STNCL1	TOOL, STENCIL, 700-DC2874A REV05
MP5	RING,LUG,#10,CRIMP,8 A W/G,FLAT, NON-INSULATED,SOLDERLESS TERMINAL
MP6	RING,LUG,#10,CRIMP,8 A W/G,FLAT, NON-INSULATED,SOLDERLESS TERMINAL
MP7	RING,LUG,#10,CRIMP,8 A W/G,FLAT, NON-INSULATED,SOLDERLESS TERMINAL
MP8	RING,LUG,#10,CRIMP,8 A W/G,FLAT, NON-INSULATED,SOLDERLESS TERMINAL
MP9	RING,LUG,#10,CRIMP,8 A W/G,FLAT, NON-INSULATED,SOLDERLESS TERMINAL
MP10	NUT,HEX,#10-32,BRASS
MP11	NUT,HEX,#10-32,BRASS
MP12	NUT,HEX,#10-32,BRASS
MP13	NUT,HEX,#10-32,BRASS
MP14	NUT,HEX,#10-32,BRASS
MP15	NUT,HEX,#10-32,BRASS
MP16	NUT,HEX,#10-32,BRASS
MP17	NUT,HEX,#10-32,BRASS
MP18	NUT,HEX,#10-32,BRASS
MP19	NUT,HEX,#10-32,BRASS
MP20	WASHER,#10,LOCK,EXT,TIN FINISH
MP21	WASHER,#10,LOCK,EXT,TIN FINISH
MP22	WASHER,#10,LOCK,EXT,TIN FINISH
MP23	WASHER,#10,LOCK,EXT,TIN FINISH
MP24	WASHER,#10,LOCK,EXT,TIN FINISH

 	APPROVALS PCB DES: NC APP ENG: MM	TITLE: SCHEMATIC 5V, MULTI-PHASE SILENT SWITCHER 2	PHONE: (409)432-1900 WWW.ANALOG.COM
	CUSTOMER NOTICE ANALOG DEVICES HAS MADE A BEST EFFORT TO DESIGN A SCHEMATIC THAT IS COMPLETELY ACCURATE AND RELIABLE. HOWEVER, IT REMAINS THE CUSTOMER'S RESPONSIBILITY TO VERIFY THE SCHEMATIC AND TO PROVIDE SPECIFICATIONS AND REQUIREMENTS IN THE INITIAL DESIGN PHASE. ANALOG DEVICES WILL NOT BE RESPONSIBLE FOR ANY ERRORS OR OMISSIONS IN THE SCHEMATIC THAT MAY AFFECT CIRCUIT PERFORMANCE OR RELIABILITY. ANALOG DEVICES APPLICATIONS ENGINEERING FOR ASSISTANCE.	IC NO. LTC3310S SKU NO. - SEE TABLE ON PAGE 1 SIZE: N/A DATE: 07-22-19	SCHEMATIC NO. AND REVISION: 710-DC2874A_REV05 SHEET 4 OF 4

DEMO MANUAL DC2874A-A/ DC2874A-B/DC2874A-C



ESD Caution

ESD (electrostatic discharge) sensitive device. Charged devices and circuit boards can discharge without detection. Although this product features patented or proprietary protection circuitry, damage may occur on devices subjected to high energy ESD. Therefore, proper ESD precautions should be taken to avoid performance degradation or loss of functionality.

Legal Terms and Conditions

By using the evaluation board discussed herein (together with any tools, components documentation or support materials, the "Evaluation Board"), you are agreeing to be bound by the terms and conditions set forth below ("Agreement") unless you have purchased the Evaluation Board, in which case the Analog Devices Standard Terms and Conditions of Sale shall govern. Do not use the Evaluation Board until you have read and agreed to the Agreement. Your use of the Evaluation Board shall signify your acceptance of the Agreement. This Agreement is made by and between you ("Customer") and Analog Devices, Inc. ("ADI"), with its principal place of business at One Technology Way, Norwood, MA 02062, USA. Subject to the terms and conditions of the Agreement, ADI hereby grants to Customer a free, limited, personal, temporary, non-exclusive, non-sublicensable, non-transferable license to use the Evaluation Board FOR EVALUATION PURPOSES ONLY. Customer understands and agrees that the Evaluation Board is provided for the sole and exclusive purpose referenced above, and agrees not to use the Evaluation Board for any other purpose. Furthermore, the license granted is expressly made subject to the following additional limitations: Customer shall not (i) rent, lease, display, sell, transfer, assign, sublicense, or distribute the Evaluation Board; and (ii) permit any Third Party to access the Evaluation Board. As used herein, the term "Third Party" includes any entity other than ADI, Customer, their employees, affiliates and in-house consultants. The Evaluation Board is NOT sold to Customer; all rights not expressly granted herein, including ownership of the Evaluation Board, are reserved by ADI. CONFIDENTIALITY. This Agreement and the Evaluation Board shall all be considered the confidential and proprietary information of ADI. Customer may not disclose or transfer any portion of the Evaluation Board to any other party for any reason. Upon discontinuation of use of the Evaluation Board or termination of this Agreement, Customer agrees to promptly return the Evaluation Board to ADI. ADDITIONAL RESTRICTIONS. Customer may not disassemble, decompile or reverse engineer chips on the Evaluation Board. Customer shall inform ADI of any occurred damages or any modifications or alterations it makes to the Evaluation Board, including but not limited to soldering or any other activity that affects the material content of the Evaluation Board. Modifications to the Evaluation Board must comply with applicable law, including but not limited to the RoHS Directive. TERMINATION. ADI may terminate this Agreement at any time upon giving written notice to Customer. Customer agrees to return to ADI the Evaluation Board at that time. LIMITATION OF LIABILITY. THE EVALUATION BOARD PROVIDED HEREUNDER IS PROVIDED "AS IS" AND ADI MAKES NO WARRANTIES OR REPRESENTATIONS OF ANY KIND WITH RESPECT TO IT. ADI SPECIFICALLY DISCLAIMS ANY REPRESENTATIONS, ENDORSEMENTS, GUARANTEES, OR WARRANTIES, EXPRESS OR IMPLIED, RELATED TO THE EVALUATION BOARD INCLUDING, BUT NOT LIMITED TO, THE IMPLIED WARRANTY OF MERCHANTABILITY, TITLE, FITNESS FOR A PARTICULAR PURPOSE OR NON-INFRINGEMENT OF INTELLECTUAL PROPERTY RIGHTS. IN NO EVENT WILL ADI AND ITS LICENSORS BE LIABLE FOR ANY INCIDENTAL, SPECIAL, INDIRECT, OR CONSEQUENTIAL DAMAGES RESULTING FROM CUSTOMER'S POSSESSION OR USE OF THE EVALUATION BOARD, INCLUDING BUT NOT LIMITED TO LOST PROFITS, DELAY COSTS, LABOR COSTS OR LOSS OF GOODWILL. ADI'S TOTAL LIABILITY FROM ANY AND ALL CAUSES SHALL BE LIMITED TO THE AMOUNT OF ONE HUNDRED US DOLLARS (\$100.00). EXPORT. Customer agrees that it will not directly or indirectly export the Evaluation Board to another country, and that it will comply with all applicable United States federal laws and regulations relating to exports. GOVERNING LAW. This Agreement shall be governed by and construed in accordance with the substantive laws of the Commonwealth of Massachusetts (excluding conflict of law rules). Any legal action regarding this Agreement will be heard in the state or federal courts having jurisdiction in Suffolk County, Massachusetts, and Customer hereby submits to the personal jurisdiction and venue of such courts. The United Nations Convention on Contracts for the International Sale of Goods shall not apply to this Agreement and is expressly disclaimed.

Rev. 0