

Figure 1. Physical Photo of AHV24V10KV2MAW

FEATURES

- High precision
- Full modulation range on output voltage
- positive voltage output
- Linear regulation
- Shutdown

APPLICATIONS

This power module, AHV24V10KV2MAW, is designed for achieving DC-DC conversion from low voltage to high voltage. High voltage power supply is widely used in industry, agriculture, national defense, scientific research and other fields including: X-ray machine high voltage power supply, laser high voltage power supply, spectral analysis high voltage power supply, etc. They are widely applied in ion beam deposition, ion beam assisted deposition, electron beam evaporation, electron beam welding, ion source, DC reactive magnetron sputtering, glass / fabric coating, glow discharge, microwave treatment high voltage capacitance test, CRT monitor test, high voltage cable fault test (PD testing), TWT test, and H-POT test. Particle accelerator, free electron laser, neutron source, cyclotron accelerator, capacitor and inductance pulse generator, Marx high voltage pulse

generator, and capacitor charger. Microwave heating, radio frequency amplification, nanotechnology application, electrostatic technology application, electrospinning preparation of nanofiber, high voltage power supply for nuclear power and other products.

DESCRIPTION

Draw a clear distinction between input lead and output lead: input 24V (red lead), ground electrodes (black lead), regulation wire (white lead), reference voltage 5V (yellow lead), shutdown (blue lead), and output high-tension cable (thick brown lead).

While regulating the potentiometer, connect the intermediate tap of the potentiometer with white lead, and connect the other two ends to ground (black lead) and reference voltage (yellow lead) respectively. Switch on the power, and regulate the potentiometer to have the required output voltage.

SHUTDOWN MODE OPERATION

A logic low <0.8V or a 0V on the SDN pin will turn the device off. When SDN is in logic high >1.2V or left unconnected, the product is working well.



SAFETY PRECAUTIONS

The internal protection circuit is provided in the high voltage power supply, but the high voltage short circuit shall be avoided.

Make sure the circuit is insulated perfectly, especially between the high voltage output and the surroundings so as to avoid electronic shock.

SPECIFICATIONS

Table 1. Characteristics. $T_A = 25^\circ\text{C}$, unless otherwise noted

Parameter	Symbol	Condition	Min.	Typ.	Max.	Unit/Note
Input Voltage	VPS		23	24	25	V
Quiescent Input Current	I_{INQQ}	$I_{OUT} = 0\text{mA}$	70	75	85	mA
Full Load Input Current	I_{INFLD}	$I_{OUT} = 2.0\text{mA}$	800	900	1000	mA
Input Voltage Regulation Ratio	$\Delta V_{OUT}/\Delta V_{PS}$	VPS = 23V to 25V		0.1		%
Output Voltage	V_{OUT}	$I_{OUT} = 0$ to 2.0mA	0		10000	V
Maximum Output Current	I_{OUTMAX}	VPS = 23V to 25V			2.0	mA
Stability of Reference Voltage	V_{REF}	$-20 \sim 50^\circ\text{C}$	4.95	5	5.05	V
Load				5		$\text{M}\Omega$
Regulation Mode			0 ~ 5V or 10k potentiometer			
Control Input vs. Output Linearity	$\Delta V_{REF}/\Delta V_{OUT}$			<0.2		%
Load Regulation Rate		0 to 2.0mA		≤ 0.05		%
Instantaneous Short Circuit Current	I_{SC}			<200		mA
Shutdown Supply Current	I_{SHDN}				15	mA
Shutdown Logic Input Current	I_{LOGIC}				3	μA
Shutdown Logic Low	V_{INL}				0.8	V
Shutdown Logic High	V_{INH}		1.2			V
Full Load Efficiency	η			≥ 70		%
Temperature Coefficient	TCV_O	$-20 \sim 50^\circ\text{C}$		<0.01		$\%/^\circ\text{C}$
Time Drift	Short Time Drift		<0.5		$\%/ \text{min}$	$\%/ \text{min}$
	Long Time Drift		<1		$\%/ \text{h}$	$\%/ \text{h}$
Output Voltage Temperature Stability		$-20 \sim 50^\circ\text{C}$		$< \pm 0.5$		%
Operating Temperature Range	T_{opr}		-20		55	$^\circ\text{C}$
Storage Temperature Range	T_{stg}		-45		85	$^\circ\text{C}$
External Dimensions			100×70×30			mm
Weight				320		g
				0.71		lbs
				11.29		Oz



TESTING DATA

I. DC Testing

High voltage power supply testing data (Test condition: the load is 5 MΩ)

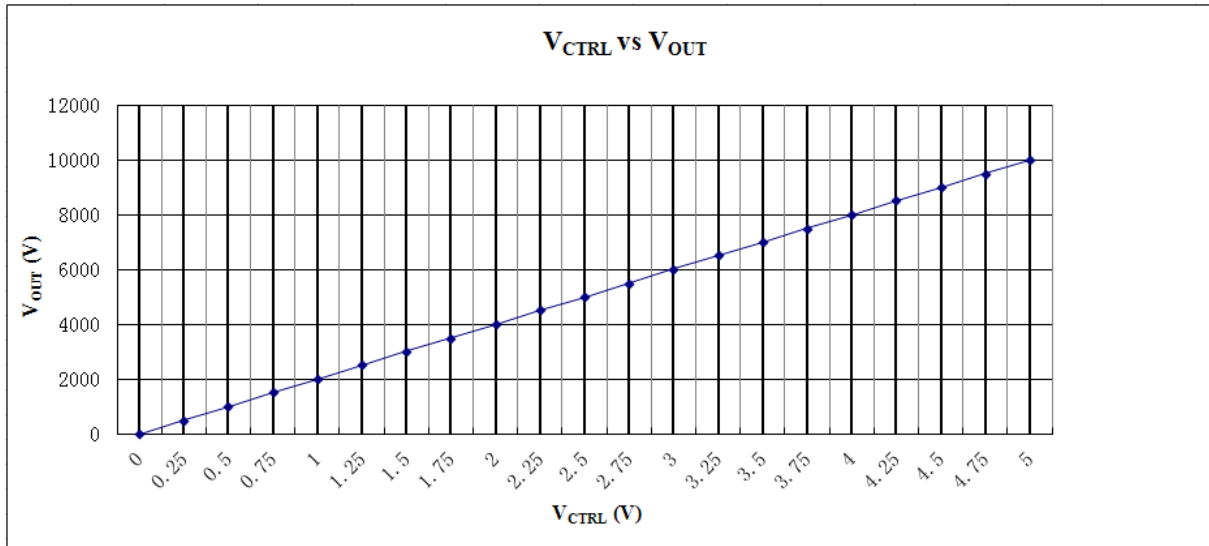

Figure 2. V_CTRL vs. V_OUT

II. AC Testing

Waveform curve and rise & fall time are tested by using the control voltage supplied by signal generator.

Under the testing condition of modulation frequency 0.1Hz, control voltage 0.25 ~ 5V, and 5MΩ load, the output voltage is 500 ~ 10000V.

Note: as shown in the figures below, the output voltage is represented by yellow line and the control voltage by red line.

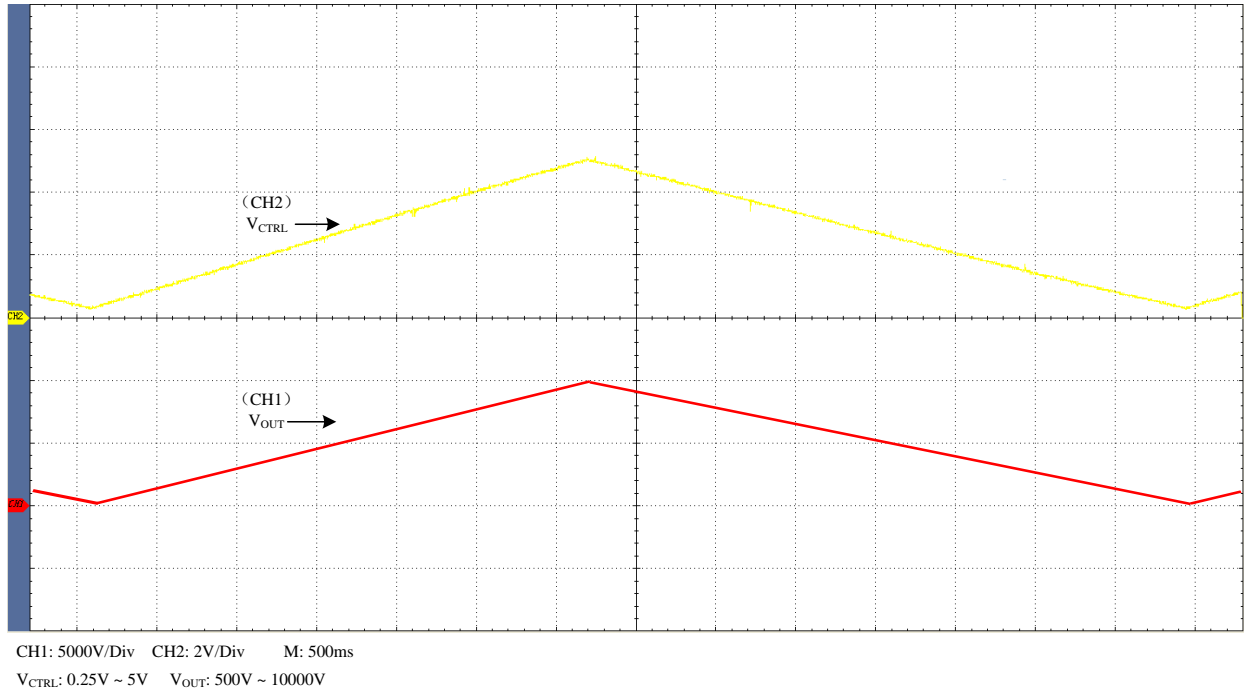

Figure 3. Triangle Wave

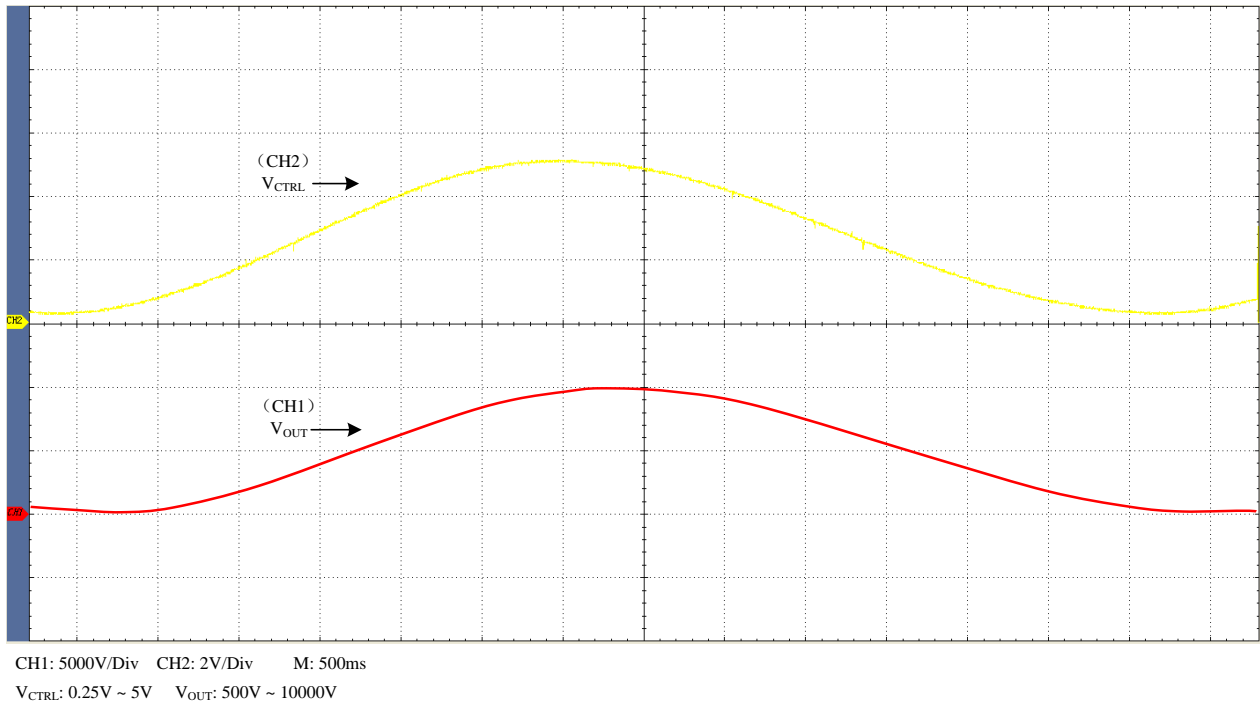

Figure 4. Sine Wave

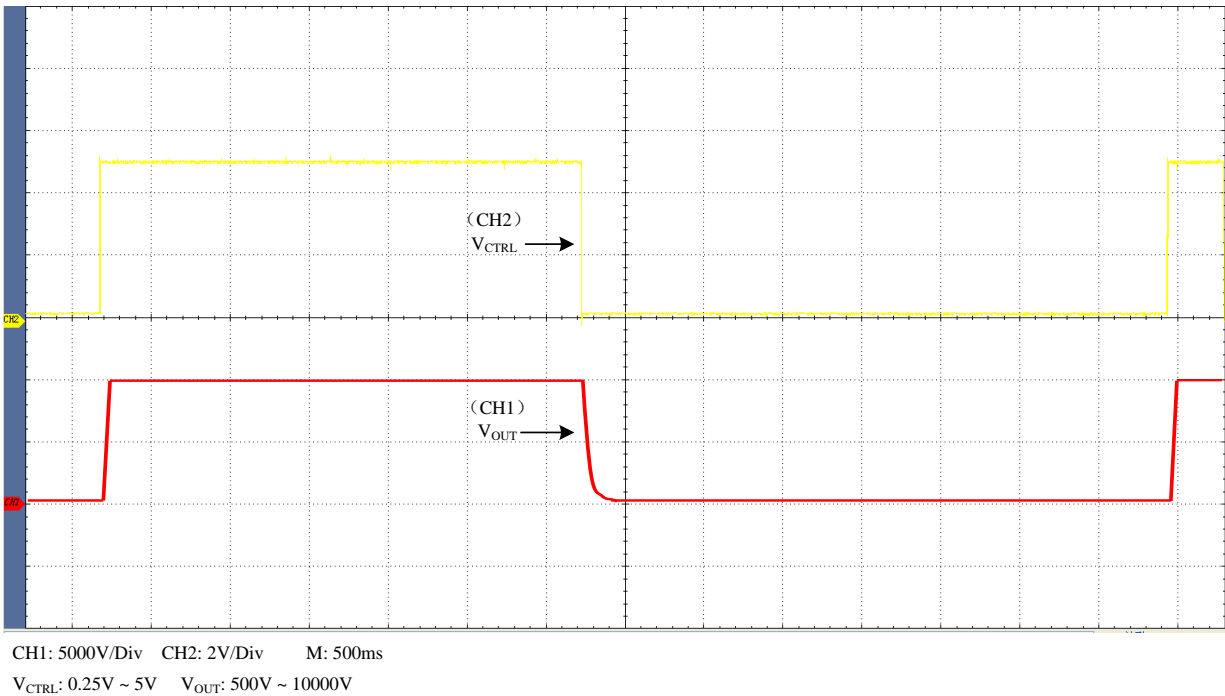

Figure 5. Square Wave

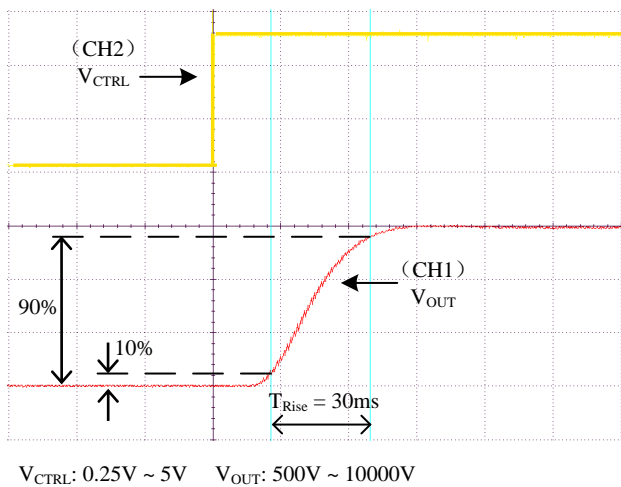

Figure 6. Rise Time

As shown in Figure 6, when a square wave of 0.25V ~ 5V, F=0.10Hz is applied to Control, measure the waveform. The rise time is about 30ms.

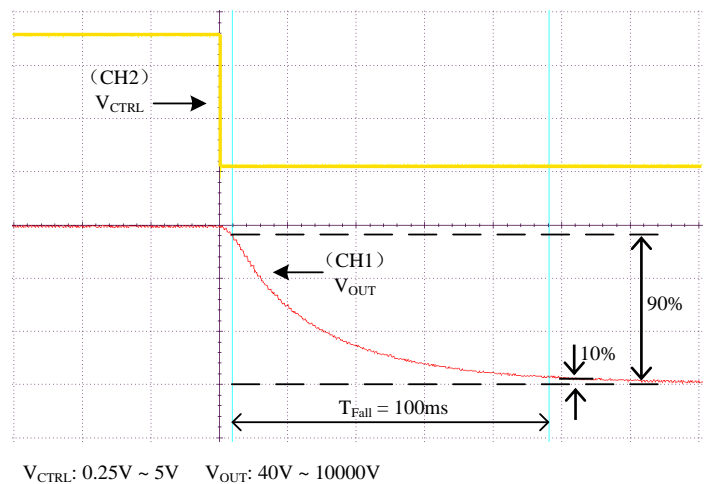

Figure 7. Fall Time

As shown in Figure 7, when a square wave of 0.25V ~ 5V, F=0.10Hz is applied to Control, measure the waveform. The fall time is about 100ms.



THE CONNECTION DIAGRAM OF MODULE' S PERIPHERAL CIRCUIT

The leads colors in the figures below are identical with those in the physical AHV24V10KV2MAW.

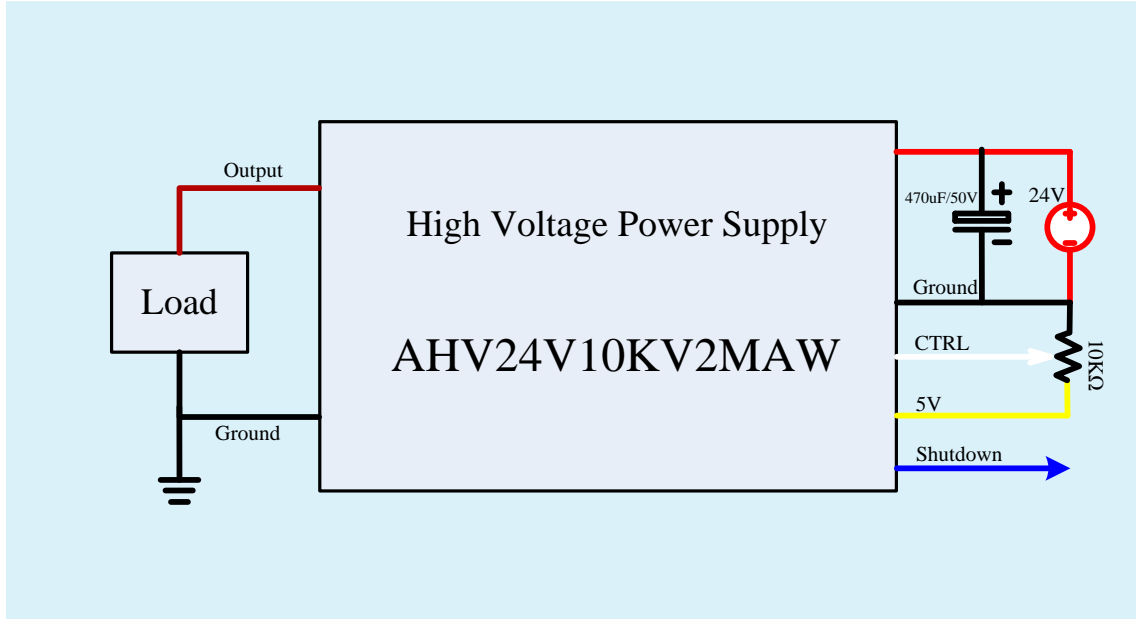

Figure 8. Control by External Signal Source

NAMING INSTRUCTIONS

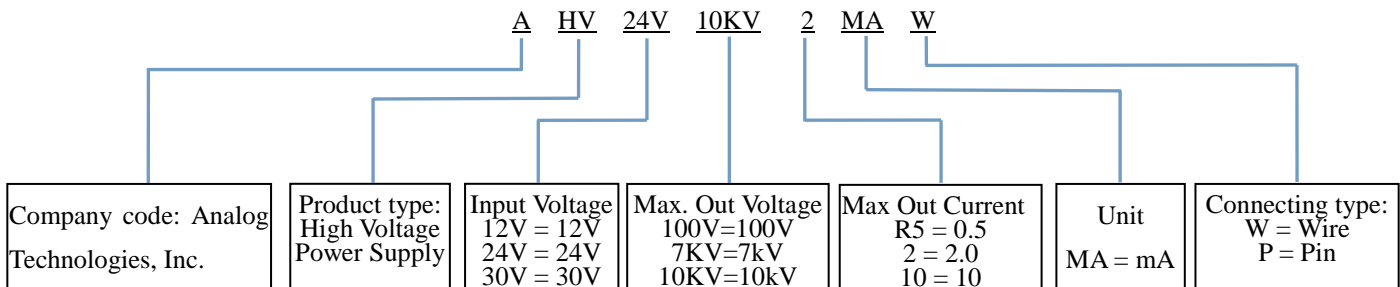

Figure 9. Naming Rules of AHV24V10KV2MAW



DIMENSIONS

I. Dimension of the leads.

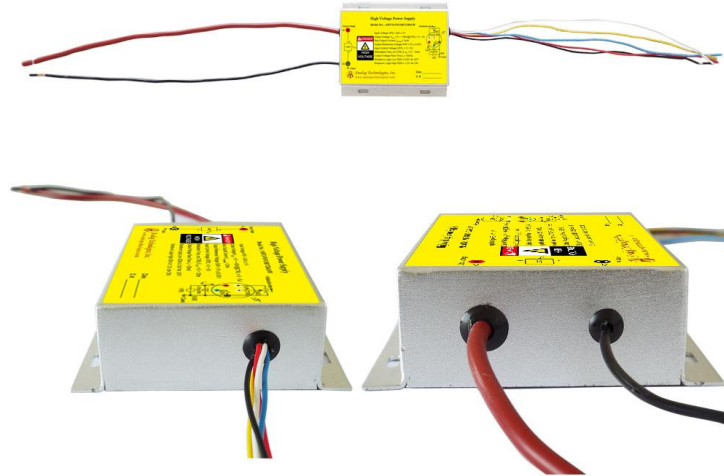

Figure 10. Leads of AHV24V10KV2MAW

Leads	Diameter (mm)	Length (mm)
Thick brown lead	4.5	26
Yellow, red, blue, black and white leads	1.5	23

II. Dimension of AHV24V10KV2MAW.

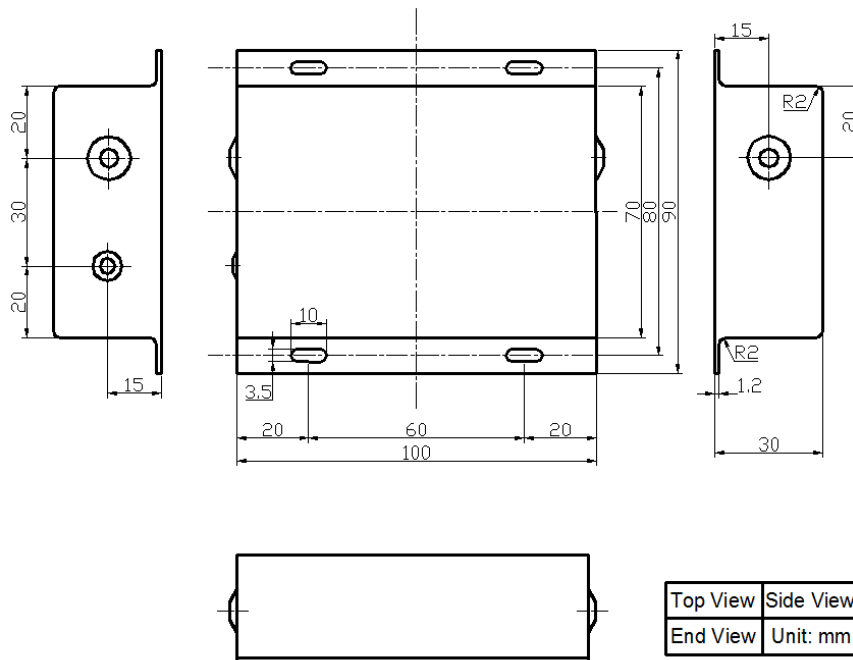

Figure 11. Dimensions for AHV24V10KV2MAW



PRICES

Quantity	1~9pcs	10~49pcs	50~99pcs	≥100
AHV24V10KV2MAW	\$359	\$349	\$339	\$329

NOTICE

- ATI warrants performance of its products for one year to the specifications applicable at the time of sale, except for those being damaged by excessive abuse. Products found not meeting the specifications within one year from the date of sale can be exchanged free of charge.
- ATI reserves the right to make changes to its products or to discontinue any product or service without notice, and advise customers to obtain the latest version of relevant information to verify, before placing orders, that information being relied on is current and complete.
- All products are sold subject to the terms and conditions of sale supplied at the time of order acknowledgment, including those pertaining to warranty, patent infringement, and limitation of liability. Testing and other quality control techniques are utilized to the extent ATI deems necessary to support this warranty. Specific testing of all parameters of each device is not necessarily performed, except those mandated by government requirements.
- Customers are responsible for their applications using ATI components. In order to minimize risks associated with the customers' applications, adequate design and operating safeguards must be provided by the customers to minimize inherent or procedural hazards. ATI assumes no liability for applications assistance or customer product design.
- ATI does not warrant or represent that any license, either express or implied, is granted under any patent right, copyright, mask work right, or other intellectual property right of ATI covering or relating to any combination, machine, or process in which such products or services might be or are used. ATI's publication of information regarding any third party's products or services does not constitute ATI's approval, warranty or endorsement thereof.
- IP (Intellectual Property) Ownership: ATI retains the ownership of full rights for special technologies and/or techniques embedded in its products, the designs for mechanics, optics, plus all modifications, improvements, and inventions made by ATI for its products and/or projects.