

Dimensions: [mm]

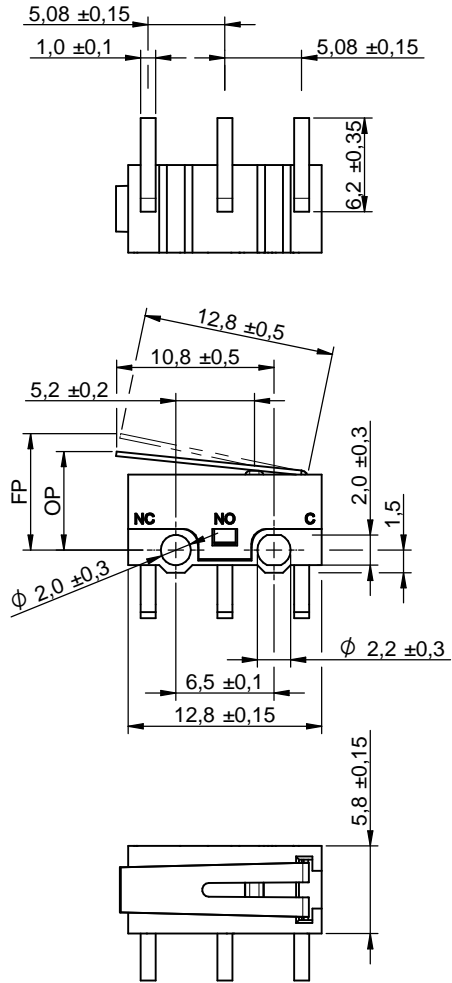

detail A

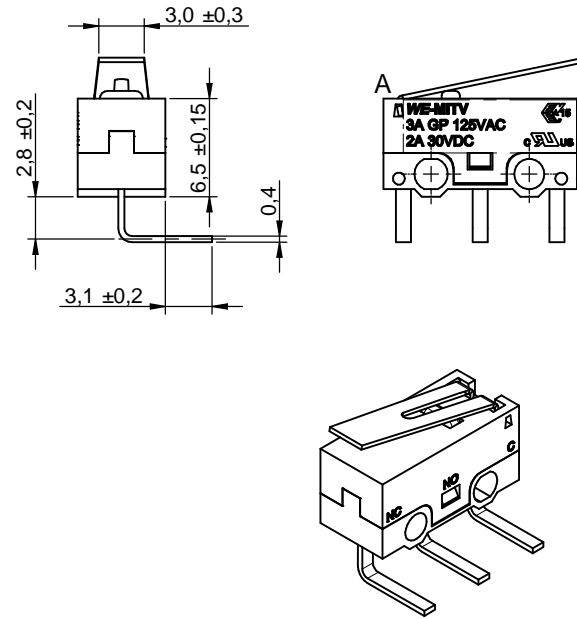

Scale - 2,5:1

Recommended Hole Pattern: [mm]

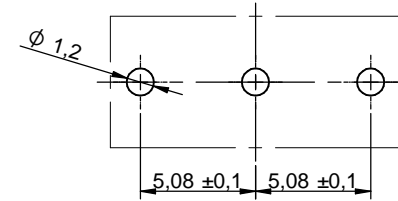

Scale - 3:1

Schematic:

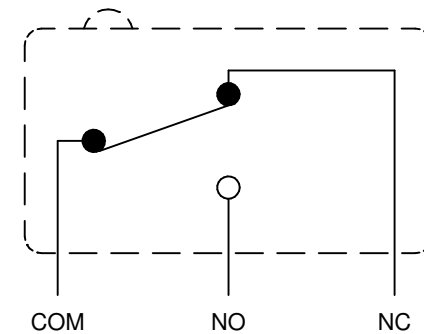

Component Marking:

Marking 1:	
1 st line	WE-MITV
2 nd line	3A GP 125VAC ENEC
3 rd line	2A 30VDC UL



Würth Elektronik eiSos GmbH & Co. KG
EMC & Inductive Solutions
Max-Eyth-Str. 1
74638 Waldenburg
Germany
Tel. +49 (0) 79 42 945 - 0
www.we-online.com
eiSos@we-online.com

CHECKED	REVISION	DATE (YYYY-MM-DD)	GENERAL TOLERANCE	PROJECTION METHOD
ICb	002.000	2021-04-19	DIN ISO 2768-1m	
DESCRIPTION				ORDER CODE
WS-MITV THT Terminal with Lever, 80 g Micro Switch				463092691402
SIZE/TYPE	BUSINESS UNIT	STATUS	PAGE	
12.8 x 5.8 mm Right Angle Operation	eiCan	Valid	1/9	

Material Properties:

Lever Material	Stainless Steel
Actuator Material	PBT
Actuator Flammability Rating	UL94 V-0
Actuator Color	White
Frame Material	PBT
Frame Flammability Rating	UL94 V-0
Frame Color	Black
Moveable Contact Material	Copper Alloy
Moveable Contact Material	Silver
Stationary Contact Material	Silver
Terminal Material	Copper Alloy
Terminal Plating	Silver

Electrical Properties:

Properties	Test conditions	Value	Unit	Tol.
Rated Current GP Load	I _R 125 V (AC)	3	A	
Rated Current Resistive Load	I _R 30 V (DC)	2	A	
Contact Resistance Initial	R	30	mΩ	max.
Contact Resistance After Life Test	R	1	Ω	max.
Insulation Resistance	R _{ISO} 500 V (DC)	100	MΩ	min.
Withstanding Voltage Pin to Pin	1 min	1000	V (AC)	
Withstanding Voltage Pin to Frame	1 min	1000	V (AC)	

Mechanical Properties:

Properties	Test conditions	Value	Unit	Tol.
Operation Force		80	g	max.
Releasing Force		5	g	min.

Mechanical Properties:

Properties	Test conditions	Value	Unit	Tol.
Free Position		10	mm	max.
Operating Position		6.8	mm	±1.2mm
Over travel		0.55	mm	min.
Movement Differential		0.5	mm	max.
Electrical Life ¹⁾	UL 61058-1	10000	Cycles	
Electrical Life	Full load AC / DC @15cycle /minute	30000	Cycles	
Mechanical Life	100 cycles /minute	1000000	Cycles	



¹⁾ Cycle - Return to the original position

General Information:

Operating Temperature	-40 up to +85 °C
Storage Conditions (in original packaging)	< 40 °C ; < 75 % RH
Moisture Sensitivity Level (MSL)	1

Certification:

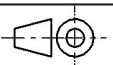
RoHS Approval	Compliant [2011/65/EU&2015/863]
REACH Approval	Conform or declared [(EC)1907/2006]
UL Approval	E483308
ENEC 15 Approval	ENEC-03305

	CHECKED	REVISION	DATE (YYYY-MM-DD)	GENERAL TOLERANCE	PROJECTION METHOD
	ICb	002.000	2021-04-19	DIN ISO 2768-1m	
	DESCRIPTION				ORDER CODE
	WS-MITV THT Terminal with Lever, 80 g Micro Switch				463092691402
	SIZE/TYPE	BUSINESS UNIT	STATUS	PAGE	
	12.8 x 5.8 mm Right Angle Operation	eiCan	Valid	2/9	

Packaging Specification - Tray: [mm]

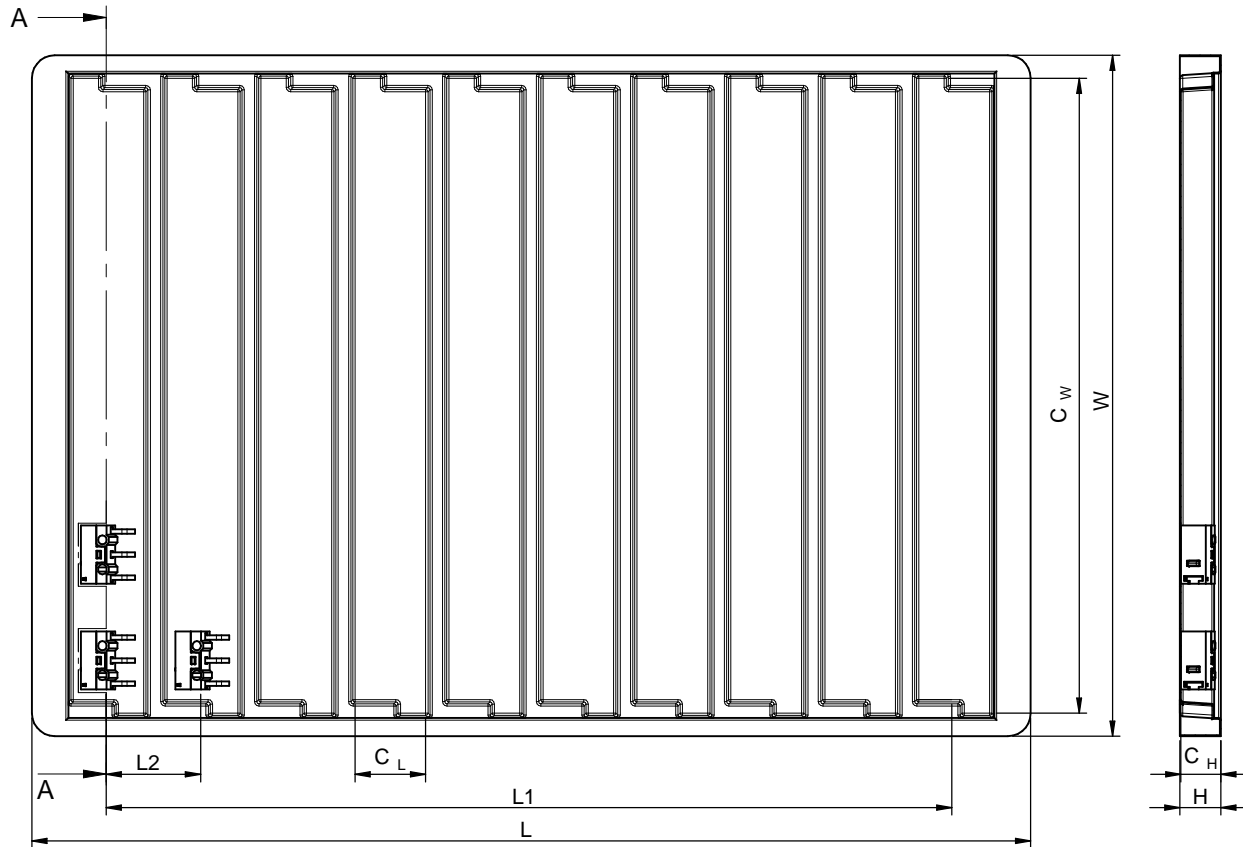

	L (mm)	L1 (mm)	L2 (mm)	CL (mm)	W (mm)	CW (mm)	H (mm)	CH (mm)	Qty. (pcs.)	Material
Tolerance	typ.	typ.	typ.	typ.	typ.	typ.	typ.	typ.		
Value	220,00	186,30	20,70	15,70	150,00	134,00	9,00	8,70	100	HIPS

Packaging Specification - Inner Carton: [mm]

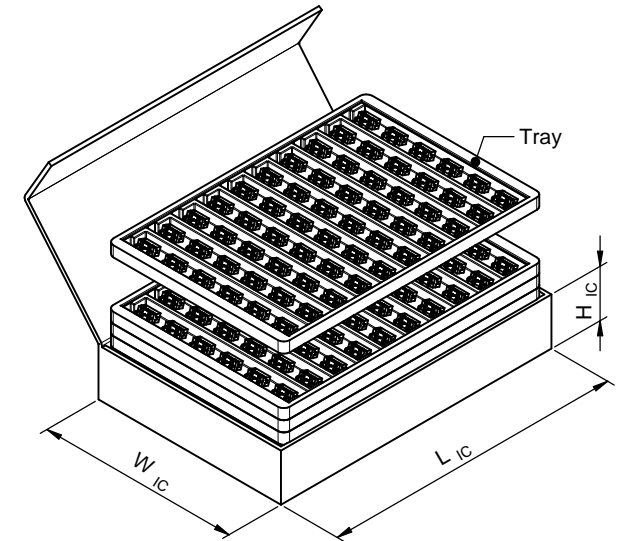

	L _{IC} (mm)	W _{IC} (mm)	H _{IC} (mm)	No. of Tray (pcs.)	Qty. (pcs.)	Material
Tolerance	typ.	typ.	typ.			
Value	230	155	40	4	400	Paper



Würth Elektronik eiSos GmbH & Co. KG
EMC & Inductive Solutions
Max-Eyth-Str. 1
74638 Waldenburg
Germany
Tel. +49 (0) 79 42 945 - 0
www.we-online.com
eiSos@we-online.com

CHECKED	REVISION	DATE (YYYY-MM-DD)	GENERAL TOLERANCE	PROJECTION METHOD
ICh	002.000	2021-04-19	DIN ISO 2768-1m	
DESCRIPTION				
WS-MITV THT Terminal with Lever, 80 g Micro Switch				ORDER CODE 463092691402
SIZE/TYPE	BUSINESS UNIT	STATUS	PAGE	
12.8 x 5.8 mm Right Angle Operation	eiCan	Valid	3/9	



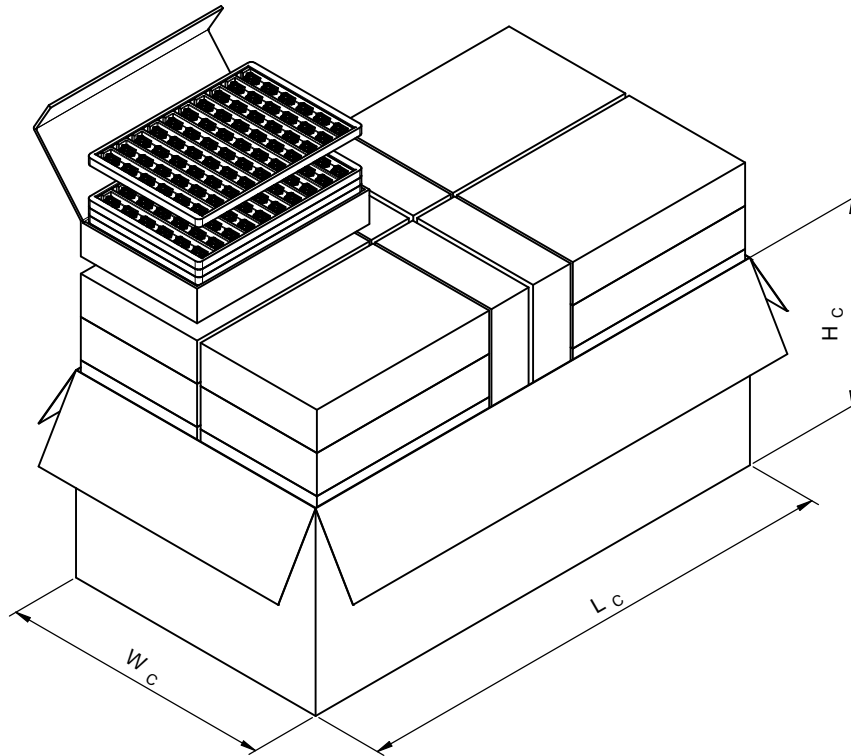



Packaging Specification - Outer Carton: [mm]



	L _{IC} (mm)	W _{IC} (mm)	H _{IC} (mm)	No. of Tray (pcs.)	Qty. (pcs.)	Material
Tolerance	typ.	typ.	typ.			
Value	230	155	40	4	400	Paper

   	CHECKED ICh	REVISION 002.000	DATE (YYYY-MM-DD) 2021-04-19	GENERAL TOLERANCE DIN ISO 2768-1m	PROJECTION METHOD 
	DESCRIPTION WS-MITV THT Terminal with Lever, 80 g Micro Switch				ORDER CODE 463092691402
	Würth Elektronik eiSos GmbH & Co. KG EMC & Inductive Solutions Max-Eyth-Str. 1 74638 Waldenburg Germany Tel. +49 (0) 79 42 945 - 0 www.we-online.com eiSos@we-online.com			BUSINESS UNIT eiCan	PAGE 4/9
	SIZE/TYPE 12.8 x 5.8 mm Right Angle Operation		STATUS Valid		

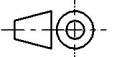
	L _C (mm)	W _C (mm)	H _C (mm)	No. of Inner Carton (pcs.)	Qty. (pcs.)	Material
Tolerance	typ.	typ.	typ.			
Value	580	320	240	24	9600	Paper

   	CHECKED ICh	REVISION 002.000	DATE (YYYY-MM-DD) 2021-04-19	GENERAL TOLERANCE DIN ISO 2768-1m	PROJECTION METHOD 
	DESCRIPTION WS-MITV THT Terminal with Lever, 80 g Micro Switch				ORDER CODE 463092691402
	Würth Elektronik eiSos GmbH & Co. KG EMC & Inductive Solutions Max-Eyth-Str. 1 74638 Waldenburg Germany Tel. +49 (0) 79 42 945 - 0 www.we-online.com eiSos@we-online.com				
	SIZE/TYPE 12.8 x 5.8 mm Right Angle Operation	BUSINESS UNIT eiCan	STATUS Valid	PAGE 5/9	







Classification Wave Soldering Profile:



Classification Wave Soldering Profile:

Profile Feature		Pb-Free Assembly	Sn-Pb Assembly
Preheat Temperature Min	$T_{s \min}$	100 °C	100 °C
Preheat Temperature Typical	$T_{s \text{ typical}}$	120 °C	120 °C
Preheat Temperature Max	$T_{s \max}$	130 °C	130 °C
Preheat Time t_s from $T_{s \min}$ to $T_{s \max}$	t_s	70 seconds	70 seconds
Ramp-up Rate	ΔT	150 °C max.	150 °C max.
Peak Temperature	T_p	250 °C - 260 °C	235 °C - 260 °C
Time of actual peak temperature	t_p	max. 10 seconds max. 5 seconds each wave	max. 10 seconds max. 5 seconds each wave
Ramp-down Rate, Min		~ 2 K/ second	~ 2 K/ second
Ramp-down Rate, Typical		~ 3.5 K/ second	~ 3.5 K/ second
Ramp-down Rate, Max		~ 5 K/ second	~ 5 K/ second
Time 25 °C to 25 °C		4 minutes	4 minutes

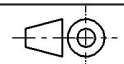
refer to EN61760-1:2006

   	CHECKED	REVISION	DATE (YYYY-MM-DD)	GENERAL TOLERANCE	PROJECTION METHOD
	ICb	002.000	2021-04-19	DIN ISO 2768-1m	
	DESCRIPTION WS-MITV THT Terminal with Lever, 80 g Micro Switch				
	Würth Elektronik eiSos GmbH & Co. KG EMC & Inductive Solutions Max-Eyth-Str. 1 74638 Waldenburg Germany Tel. +49 (0) 79 42 945 - 0 www.we-online.com eiSos@we-online.com				
	SIZE/TYPE	BUSINESS UNIT	STATUS	PAGE	
12.8 x 5.8 mm Right Angle Operation	eiCan	Valid	6/9		

Cautions and Warnings:

The following conditions apply to all goods within the product series of Micro-switch of Würth Elektronik eiSos GmbH & Co. KG:

General:

- This mechanical component is designed and manufactured for use in general electronic equipment.
- Würth Elektronik must be asked for written approval (following the PPAP procedure) before incorporating the components into any equipment in fields such as military, aerospace, aviation, nuclear control, submarine, transportation (automotive control, train control, ship control), transportation signal, disaster prevention, medical, public information network, etc. where higher safety and reliability are especially required and/or if there is the possibility of direct damage or human injury.
- Mechanical components that will be used in safety-critical or high-reliability applications, should be pre-evaluated by the customer.
- The component is designed and manufactured to be used within the datasheet specified values. If the usage and operation conditions specified in the datasheet are not met, the component may be damaged or dissolved.
- Do not drop or impact the components, the component may be damaged.
- Prevent any damage or scratches on the switch, especially on the actuator.
- Würth Elektronik products are qualified according to international standards, which are listed in each product reliability report. Würth Elektronik does not warrant any customer qualified product characteristics beyond Würth Elektronik's specifications, for its validity and sustainability over time.
- The responsibility for the applicability of the customer specific products and use in a particular customer design is always within the authority of the customer. All technical specifications for standard products also apply to customer specific products.

Product specific:

Soldering:

- The solder profile must comply with the technical product specifications. All other profiles will void the warranty.
- All other soldering methods are at the customers' own risk.
- Please keep our switch at delivery original position before and during the soldering process.
- Design the right angle part with consideration of the wave soldering process so that the parts will not touch the soldering wave during the soldering process or protect the switch part with cover fixture. Melt of the switch might cause malfunction.

Cleaning and Washing:

- If a series is washable, the general information section in the datasheet will contain the washability guidelines. Should there be no information regarding washability, the product has not been constructed to withstand a washing process. Washing agents used during the production to clean the customers' application might damage or change the characteristics of the component, body, pins and/or termination. Washing agents may have a negative effect on the long-term functionality of the product.

If the parts are washable, hermetic:

- Cleaning agents used to clean the customers' applications, may damage or change the characteristics of the component, body, pins and/or termination.
- Please do not immerse any washable products into water or cleaning agents nor put them in locations exposed to water completely.
- Do not clean washable series immediately after soldering. The cleaning agent may be absorbed into the switch through respiration while the switch cools.
- Please do not press actuator or change status/position during the cleaning and washing process.
- Using a brush during the cleaning process may deform function relevant areas. Therefore, we do not recommend using a brush during the PCB cleaning process.

Potting and Coating:

- If the product is potted in the customer application, the potting material may shrink or expand during and after hardening. Shrinking could lead to an incomplete seal, allowing contaminants into the body, pins or termination. Expansion could damage the components. We recommend a manual inspection after potting or coating to avoid these effects.

Storage Conditions:



- A storage of Würth Elektronik products for longer than 12 months is not recommended. Within other effects, the terminals may suffer degradation, resulting in bad solderability. Therefore, all products shall be used within the period of 12 months based on the day of shipment.
- Do not expose the components to direct sunlight.
- The storage conditions in the original packaging are defined according to DIN EN 61760-2.
- For a moisture sensitive component, the storage condition in the original packaging is defined according to IPC/JEDEC-J-STD-033. It is also recommended to return the component to the original moisture proof bag and reseal the moisture proof bag again.
- The storage conditions stated in the original packaging apply to the storage time and not to the transportation time of the components.

Packaging:

- The packaging specifications apply only to purchase orders comprising whole packaging units. If the ordered quantity exceeds or is lower than the specified packaging unit, packaging in accordance with the packaging specifications cannot be ensured.

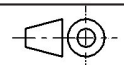

Handling:

- The switch shall be assembled while in OFF state.
- The effector should be positioned so that direct force is not applied to the actuator on its free position (NC circuit). The operating force to the actuator should only be applied vertically.
- For NO (Normally Open) circuit, the actuator should be pressed down at least until it reaches the pre-travel or Operating Position (OP position). To reduce possible errors, it is recommended to reduce the lowest tolerance of the operating position (OP) by further 0.2 mm.

 	CHECKED	REVISION	DATE (YYYY-MM-DD)	GENERAL TOLERANCE	PROJECTION METHOD	
	ICb	002.000	2021-04-19	DIN ISO 2768-1m		
	DESCRIPTION					
WS-MITV THT Terminal with Lever, 80 g Micro Switch					463092691402	
SIZE/TYPE				BUSINESS UNIT	STATUS	PAGE
12.8 x 5.8 mm Right Angle Operation				eiCan	Valid	7/9

- The switch can be operated as specified in the illustration. Other ways of operation may lead to malfunction or break the switch.
- Actuator type should be selected according to the activation method, activation speed, activation rate and activation frequency. 1) A slower activation speed than commonly used may cause unstable contact transfer, possibly resulting in contact failures or contact fusion. 2) A higher activation speed than commonly used may cause damage to the contacts or contact response failure.
- Use of a driving (roller type) mechanism, which may cause physical impact to the actuator, shall be avoided.
- When wiring the micro-switch, the proper wire for the applied voltage and current must be chosen. During the wiring process, it must be ensured that the power supply is switched OFF.
- Continuous exposure of the switch to vibration or shock may result in contact failure or fault operation due to abrasion powder and resulting in reduced durability. Excessive vibration or shock will lead in malfunction of the contacts or even get damaged.
- When mounting holes for 12.8 mm, use M2 mounting screws with washers to mount the switch. Do not tighten the screws with a torque over 0.1 N-m.
- When mounting holes for 19.8 mm, use M2 mounting screws with washers to mount the switch. Do not tighten the screws with a torque over 0.26 N-m.
- After mounting and wiring, check the insulation distance between terminals and ground. If the insulation distance is inadequate, insulating material in between is required.
- The switch shall not be mounted upside down. It may lead to wrong interpretation of the free position and can cause malfunction of the use of the switch.
- The micro-switch contact may experience bouncing or chattering during the switching. Bouncing or chattering can cause noise or pulse count errors, when the snap action switch is used in an electronic circuit. Chattering behavior may vary depending on the speed of operation. Our definition of 10 ms is according to the term of our test with a speed of 100 mm/minute and measure on total travel position.
- All our reliability tests are measured in free position for (NC) and in total travel position for (NO).
- Our switches are not suitable where hydrogen sulfide or other corrosive gases are present. Non-washable types are also not suitable for dusty environments.
- Condensation will occur inside the switch if there is a sudden change in ambient temperature, when used in an atmosphere of high temperature and high humidity.
- The temperature rise of the component must be taken into consideration. The operating temperature is comprised of ambient temperature and temperature rise of the component. The operating temperature of the component shall not exceed the maximum temperature specified.

These cautions and warnings comply with the state of the scientific and technical knowledge and are believed to be accurate and reliable. However, no responsibility is assumed for inaccuracies or incompleteness.

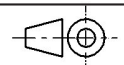
 		CHECKED ICh	REVISION 002.000	DATE (YYYY-MM-DD) 2021-04-19	GENERAL TOLERANCE DIN ISO 2768-1m	PROJECTION METHOD 
	DESCRIPTION WS-MITV THT Terminal with Lever, 80 g Micro Switch					ORDER CODE 463092691402
SIZE/TYPE 12.8 x 5.8 mm Right Angle Operation			BUSINESS UNIT eiCan	STATUS Valid	PAGE 8/9	

Important Notes

The following conditions apply to all goods within the product range of Würth Elektronik eiSos GmbH & Co. KG:

1. General Customer Responsibility

Some goods within the product range of Würth Elektronik eiSos GmbH & Co. KG contain statements regarding general suitability for certain application areas. These statements about suitability are based on our knowledge and experience of typical requirements concerning the areas, serve as general guidance and cannot be estimated as binding statements about the suitability for a customer application. The responsibility for the applicability and use in a particular customer design is always solely within the authority of the customer. Due to this fact it is up to the customer to evaluate, where appropriate to investigate and decide whether the device with the specific product characteristics described in the product specification is valid and suitable for the respective customer application or not.

2. Customer Responsibility related to Specific, in particular Safety-Relevant Applications

It has to be clearly pointed out that the possibility of a malfunction of electronic components or failure before the end of the usual lifetime cannot be completely eliminated in the current state of the art, even if the products are operated within the range of the specifications. In certain customer applications requiring a very high level of safety and especially in customer applications in which the malfunction or failure of an electronic component could endanger human life or health it must be ensured by most advanced technological aid of suitable design of the customer application that no injury or damage is caused to third parties in the event of malfunction or failure of an electronic component. Therefore, customer is cautioned to verify that data sheets are current before placing orders. The current data sheets can be downloaded at www.we-online.com.

3. Best Care and Attention

Any product-specific notes, cautions and warnings must be strictly observed. Any disregard will result in the loss of warranty.

4. Customer Support for Product Specifications

Some products within the product range may contain substances which are subject to restrictions in certain jurisdictions in order to serve specific technical requirements. Necessary information is available on request. In this case the field sales engineer or the internal sales person in charge should be contacted who will be happy to support in this matter.

5. Product R&D

Due to constant product improvement product specifications may change from time to time. As a standard reporting procedure of the Product Change Notification (PCN) according to the JEDEC-Standard inform about minor and major changes. In case of further queries regarding the PCN, the field sales engineer or the internal sales person in charge should be contacted. The basic responsibility of the customer as per Section 1 and 2 remains unaffected.

6. Product Life Cycle



Due to technical progress and economical evaluation we also reserve the right to discontinue production and delivery of products. As a standard reporting procedure of the Product Termination Notification (PTN) according to the JEDEC-Standard we will inform at an early stage about inevitable product discontinuance. According to this we cannot guarantee that all products within our product range will always be available. Therefore it needs to be verified with the field sales engineer or the internal sales person in charge about the current product availability expectancy before or when the product for application design-in disposal is considered. The approach named above does not apply in the case of individual agreements deviating from the foregoing for customer-specific products.

7. Property Rights

All the rights for contractual products produced by Würth Elektronik eiSos GmbH & Co. KG on the basis of ideas, development contracts as well as models or templates that are subject to copyright, patent or commercial protection supplied to the customer will remain with Würth Elektronik eiSos GmbH & Co. KG. Würth Elektronik eiSos GmbH & Co. KG does not warrant or represent that any license, either expressed or implied, is granted under any patent right, copyright, mask work right, or other intellectual property right relating to any combination, application, or process in which Würth Elektronik eiSos GmbH & Co. KG components or services are used.

8. General Terms and Conditions

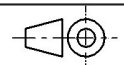
Unless otherwise agreed in individual contracts, all orders are subject to the current version of the "General Terms and Conditions of Würth Elektronik eiSos Group", last version available at www.we-online.com.

	CHECKED	REVISION	DATE (YYYY-MM-DD)	GENERAL TOLERANCE	PROJECTION METHOD
	ICb	002.000	2021-04-19	DIN ISO 2768-1m	
	DESCRIPTION WS-MITV THT Terminal with Lever, 80 g Micro Switch				ORDER CODE 463092691402
	Würth Elektronik eiSos GmbH & Co. KG EMC & Inductive Solutions Max-Eyth-Str. 1 74638 Waldenburg Germany Tel. +49 (0) 79 42 945 - 0 www.we-online.com eiSos@we-online.com			BUSINESS UNIT eiCan	STATUS Valid
	SIZE/TYPE 12.8 x 5.8 mm Right Angle Operation	PAGE 9/9			