

**Order Number**  
**213309-3400**

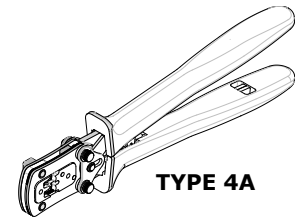

**Application Tooling Specification**



**FEATURES**

- A full cycle ratcheting hand tool ensures complete crimps
- Ergonomically designed soft handles
- Precisely designed crimping profiles with simple contact positioning
- Easy handling due to outstanding force ratio
- Modular crimp head is removable and can be used in the Electric Crimp Machine (Order No. 63816-1900), accompanied by Battery Powered Crimp Adapter (Order No. 63816-1950)
- Can also be used in the Battery Powered Tool Order No. 63816-0270 (110 V) or 63816-0280 (220 V), accompanied by Battery Powered Crimp Adapter (Order No. 63816-1950)
- This tool is RoHS compliant

**SCOPE**

**Products:** CP-6.5 Wire-to-Wire Crimp Terminals, 16-18 AWG Wire.

Terminal Series No.	Terminal Order No.		Wire Size and Type		** Insulation Diameter		Wire Strip Length	
	Loose Piece	*Reel	AWG	Wire Type	mm	In.	mm	In.
50597	50597-8100	50597-8000	16	UL1007	2.20-2.50	.086-.098	2.70-3.30	.106-.130
	50597-8110	50597-8010	18	UL1007	2.00-2.20	.079-.086		
205033	—	205033-8000	16	UL1007	2.20-2.50	.086-.098		
			18	UL1007	2.00-2.20	.079-.086		

\* Customer to cut off terminal from reel: 0.25mm (.010") maximum cut-off tab.  
\*\* See crimp specification for the individual insulation diameter.

**DEFINITION OF TERMS**

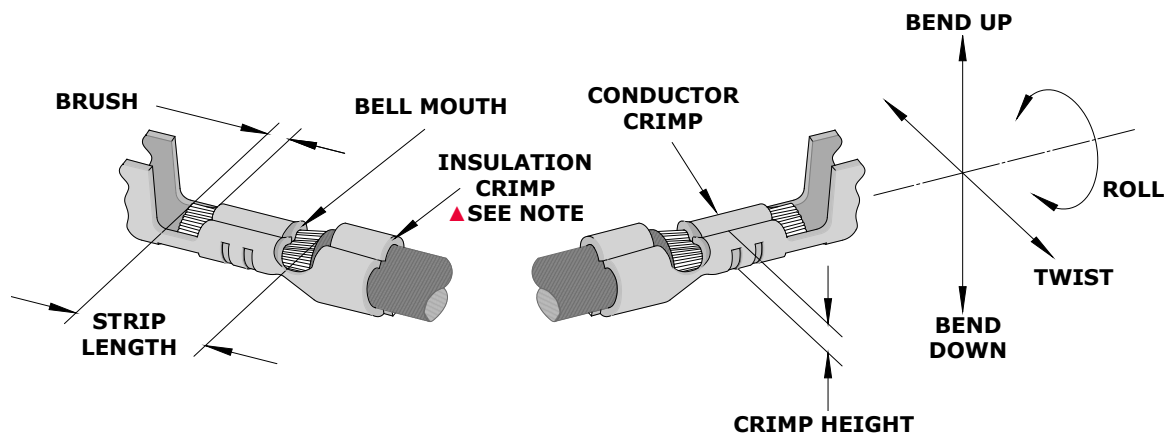

This illustration is a generic terminal representation and not an exact image of any terminal listed in the scope.

**▲ Insulation Crimp Note**

Due to the terminal’s insulation grip design or insulation diameter range, this tool uses overlap form geometry in the insulation punch. This produces an overlap insulation crimp (A-620-compliant). Although the insulation punch profile may appear lopsided, this is a normal condition for this tool. See figure to the right. Some tools with multiple crimp pockets may not have the overlap profile on all pockets.

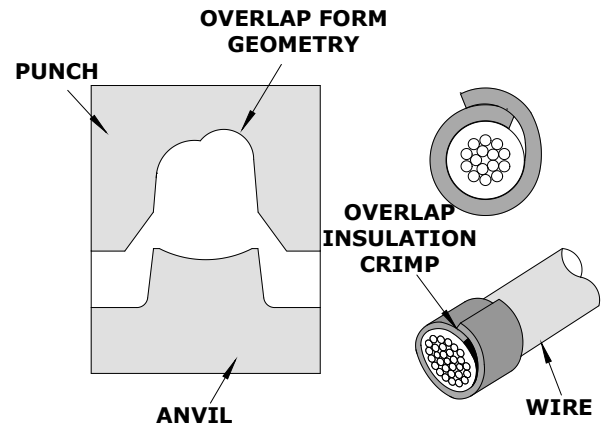

**CRIMP SPECIFICATION**

After crimping, the crimp profiles should measure the following:

Terminal Series No.	Wire Size		Conductor Crimp				Insulation Crimp		Pull Force Minimum		Profile	
			Height		Width (Ref.)		Height (Ref.)					
	AWG	Type	mm	In.	mm	In.	mm	In.	N	Lb.	16	18
50597	16	UL1007	1.21-1.31	.048-.052	1.85	.073	3.15	.124	127.49	28.7	X	
	18	UL1007	1.16-1.26	.046-.050	1.85	.073	3.05	.120	107.8	24.2		X
205033	16	UL1007	1.21-1.31	.048-.052	1.85	.073	3.15	.124	127.49	28.7	X	
	18	UL1007	1.16-1.26	.046-.050	1.85	.073	3.05	.120	107.8	24.2		X

**Tool Qualification Notes**

1. (Ref) means the dimension provided is approximate due to the wide range of wires, conductor stranding, insulation diameters and insulation hardness.
2. An occasional conductor crimp height measurement should be performed. It must lie between the minimum and maximum crimp height specification.
3. Pull force should be measured with no influence from the insulation crimp. To ensure this, strip the wire long enough so the terminal insulation grips do not contact the wire insulation.

**Notes**

1. This tool should only be used for the terminals and stranded wire gauges specified on this sheet.
2. This tool is not adjustable for crimp height. Variations in tools, terminals, wire stranding and insulation types may affect crimp height.
3. This tool should only be used for AWG conductor sizes. It may not give good insulation crimp support for insulation sizes outside of the specified range.
4. Molex does not repair hand tools (see warranty below). The replacement parts listed are the only parts available for repair. If the handles or crimp tooling become damaged or worn, a new tool must be purchased.
5. Conductor crimp height should be used as the final criterion for an acceptable crimp. Refer to Molex Quality Crimping Handbook 63800-0029 for additional information on crimping and crimp testing.
6. Molex does not certify hand crimp tools.

## OPERATION

Open the tool by squeezing the handles together. At the end of the closing stroke, the ratchet mechanism will release the handles, and the hand tool will spring open.

1. Lift the wire stop blade.
2. Insert the terminal into the correct profile until the terminal is fully seated and stops.
3. Partially close the tool to hold the terminal in place.
4. Lower the wire stop blade.
5. Slide a pre-stripped wire into the terminal until it touches the wire stop, and visually align the wire with the conductor and insulation grips. See Figures 1 and 2.

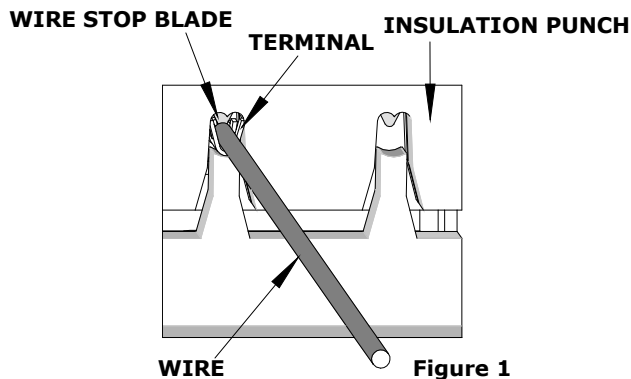

6. Close the tool until the ratchet releases. The tool handles will then spring open.
7. Lift the wire stop blade if it is still in the down position.
8. Carefully remove the crimped terminal.

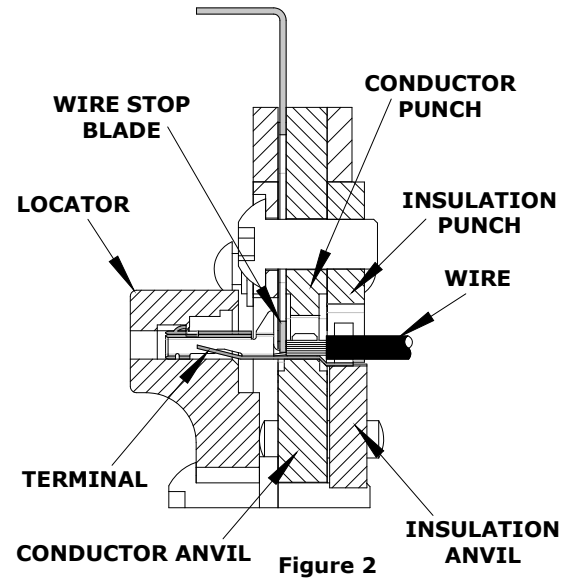

**Note:** The tamper-proof ratchet action will not release the tool until it has been fully closed.

## MAINTENANCE

It is recommended that each operator of the tool be made aware of and responsible for the following maintenance steps:

1. Remove dust, moisture and other contaminants with a clean brush or a soft, lint-free cloth.
2. Do not use any abrasive materials that could damage the tool.
3. Make certain all pins, pivot points and bearing surfaces are protected with a thin coat of high-quality machine oil. Do not oil excessively. The tool was engineered for durability, but like any other equipment, it needs cleaning and lubrication for a maximum service life of trouble-free crimping. Light oil (such as 30 weight automotive oil) used at the oil points every 5,000 crimps or 3 months will significantly enhance the tool life.
4. Wipe excess oil from hand tool, particularly from crimping area. Oil transferred from the crimping area onto certain terminations may affect the electrical characteristics of an application.
5. When the tool is not in use, keep the handles closed to prevent objects from becoming lodged in the crimping dies, and store the tool in a clean, dry area.

### Miscrimps or Jams

Should this tool ever become stuck or jammed in a partially closed position, **do not force the handles open or closed**. The tool will open easily by lifting the ratchet release lever. See Figure 6.

## Warranty

This tool is for electrical terminal crimping purposes only. This tool is made of the best quality materials. All vital components are long life tested. All tools are warranted to be free of manufacturing defects for a period of 30 days. Should such a defect occur, Molex will repair or exchange the tool free of charge. This repair or exchange will not be applicable to altered, misused or damaged tools. This tool is designed for hand use only. Any clamping, fixturing or use of handle extensions voids this warranty.

**CAUTION:** Repetitive use of this tool should be avoided.

## CAUTIONS

1. Manually powered hand tools are intended for low-volume use or field repair. This tool is **NOT** intended for production use. Repetitive use of this tool should be avoided.
2. Insulated rubber handles are not protection against electrical shock.
3. Wear eye protection at all times.
4. Use only the Molex terminals specified for crimping with this tool.

**CAUTION:** Molex crimp specifications are valid only when used with Molex terminals and tooling.

**APPLICATIONS FOR THE MODULAR CRIMP HEAD**

**WARNING:** NEVER operate, service, install or adjust this modular crimp head without proper instruction and without first reading and understanding the instructions in the proper manual or specification sheet. See chart below for the correct manual or specification sheet.

**WARNING:** NEVER install tooling or service this tool while it is plugged into any power source. Disconnect the power by unplugging, or turn off the actuator from its power source.

**CAUTION:** Keep fingers away from the crimping area when operating this tool. It may cause severe injury.

**CAUTION:** Wear safety glasses when operating or servicing this tool.

The chart below shows all applications for this modular crimp head:

Tool Order No.	Tool Description	Adapter Order No.	Adapter Description	Figure No.
63816-0000	Hand Crimp Frame (Short)	—	—	3
63816-0050	Hand Crimp Frame (Long)	—	—	3
63816-0270	Battery Power Tool (110 V)	63816-1950	Battery Power Crimp Adapter	4
63816-0280	Battery Power Tool (220 V)	63816-1950	Battery Power Crimp Adapter	4
63816-1900	Electric Crimp Machine	63816-1950	Battery Power Crimp Adapter	5

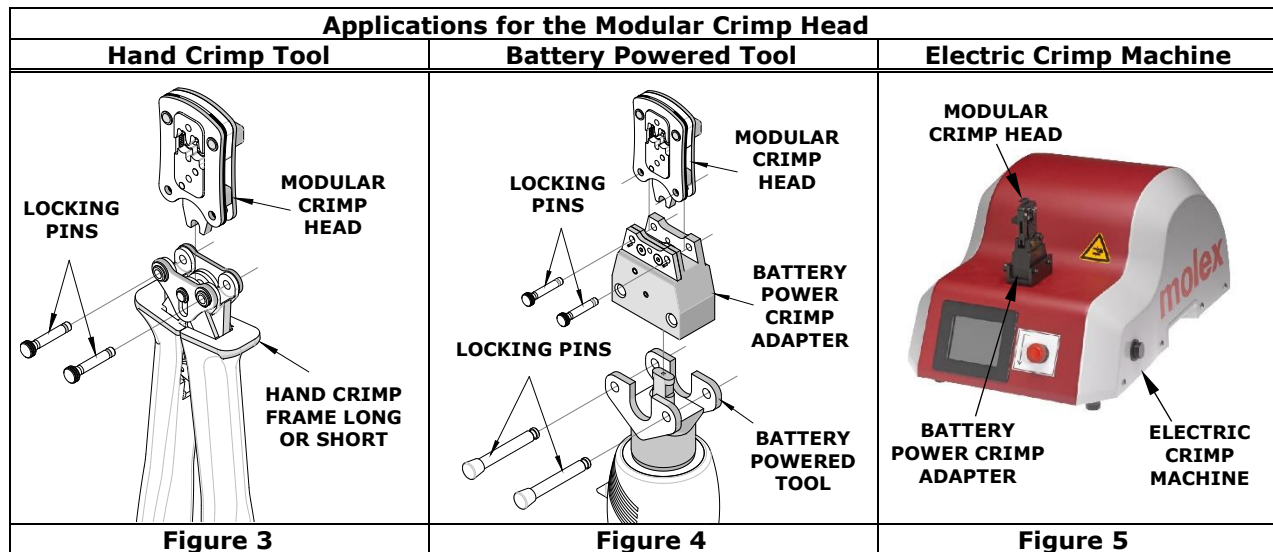

**PARTS LIST**

Hand Crimp Tool 213309-3400			
Item	Order Number	Description	Quantity
1	213309-3470	Modular Crimp Head	1 (Ref)
2	63816-0050	Hand Crimp Frame (Long)	1 (Ref)
3	213309-3475	Locator	1
4	63816-0001	Locking Pin	2
5	63600-0525	Handle Spring	1
6	63600-0520	Crimping Spring	2

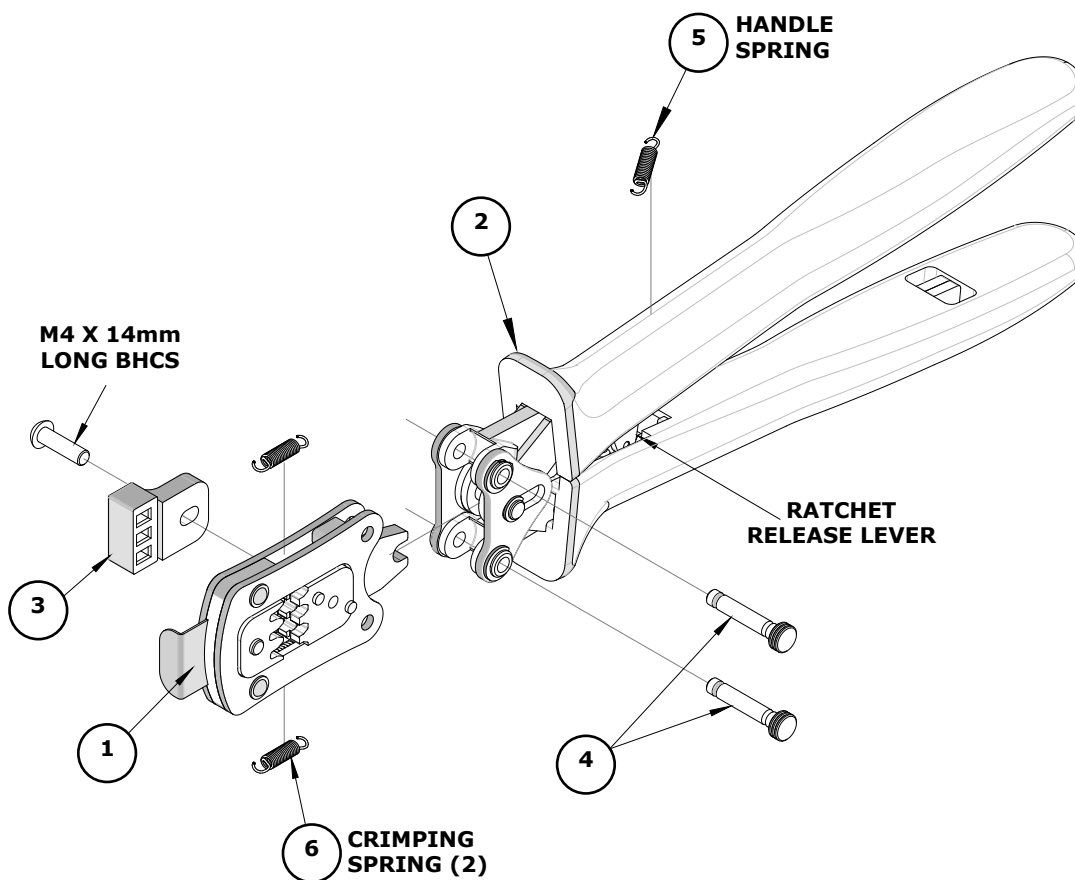

Figure 6

**Application Tooling Support**

**Phone:** (402) 458-TOOL (8665)  
**E-Mail:** toolingsupport@molex.com  
**Website:** www.molex.com/applicationtooling

Molex is a registered trademark of Molex, LLC in the United States of America and may be registered in other countries; all other trademarks listed herein belong to their respective owners.