

**Data sheet | Item number: 2116-1204**

2-conductor through terminal block; with lever and Push-in CAGE CLAMP®; 16 mm²; with test port; suitable for Ex i applications; side and center marking; for DIN-rail 35 x 15 and 35 x 7.5; Push-in CAGE CLAMP®; 16,00 mm²; blue

[www.wago.com/2116-1204](http://www.wago.com/2116-1204)

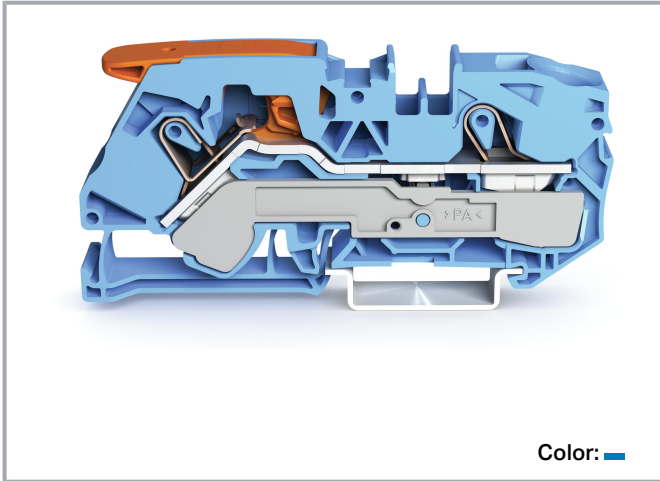

Color: 

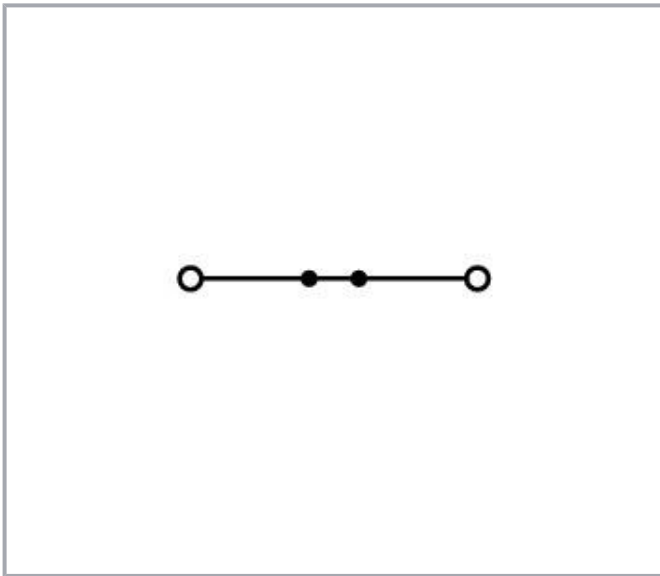
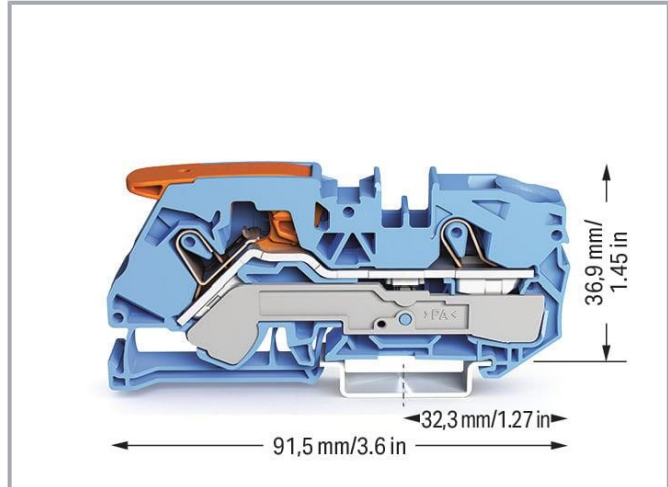

**Data**

**Electrical data**

**Ratings per IEC/EN**

Ratings per	IEC/EN 60947-7-1
Nominal voltage (III/3)	800 V

Subject to changes. Please also observe the further product documentation!

WAGO GmbH & Co. KG  
Hansastr. 27  
32423 Minden  
Phone: +49571 887-0 | Fax: +49571 887-169  
Email: [info.de@wago.com](mailto:info.de@wago.com) | Web: [www.wago.com](http://www.wago.com)

Do you have any questions about our products?  
We are always happy to take your call at +49 (571) 887-44222.



Rated impulse voltage (III/3)	8 kV
Rated current	76 A
Current at conductor cross-section (max.) mm <sup>2</sup>	90 A
Note (rated current)	15 mm high DIN-35 rails shall be used for a current load higher than 76 A!
Legend (ratings)	(III / 3) ≙ Overvoltage category III / Pollution degree 3

### Ratings per UL 1059

Approvals per	UL 1059
Rated voltage UL (Use Group B)	600 V
Rated current UL (Use Group B)	85 A
Rated voltage UL (Use Group C)	600 V
Rated current UL (Use Group C)	85 A

### Ratings per CSA

Approvals per	CSA 22.2 No 158
Rated voltage CSA (Use Group B)	600 V
Rated current CSA (Use Group B)	85 A
Rated voltage CSA (Use Group C)	600 V
Rated current CSA (Use Group C)	85 A

### Ex information

Reference hazardous areas	See "Downloads – Documentation – Additional Information: Technical Section; Technical Explanations"
Ratings per	ATEX: PTB 18 ATEX 1012 U / IECEx: PTB 18.0019U (Ex eb IIC Gb)
Rated voltage EN (Ex e II)	550 V
Rated current (Ex e II)	76 A
Rated current (Ex e II) with jumper	65 A

### Power loss

Power loss, per pole (potential)	2.426 W
Rated current $I_N$ for specified power loss	76 A
Resistance value for specified, current-dependent power loss	0 Ω

### Connection data

Connection points	2
-------------------	---

Subject to changes. Please also observe the further product documentation!



Total number of potentials	1
Number of levels	1
Number of jumper slots	2

### Connection 1

Connection technology	Push-in CAGE CLAMP®
Actuation type	Lever
Connectable conductor materials	Copper
Nominal cross-section	16 mm <sup>2</sup>
Solid conductor	0.5 ... 16 mm <sup>2</sup> / 20 ... 6 AWG
Solid conductor; push-in termination	2.5 ... 16 mm <sup>2</sup> / 14 ... 6 AWG
Fine-stranded conductor	0.5 ... 25 mm <sup>2</sup> / 20 ... 4 AWG
Fine-stranded conductor; with insulated ferrule	0.5 ... 16 mm <sup>2</sup> / 20 ... 6 AWG
Fine-stranded conductor; with ferrule; push-in termination	6 ... 16 mm <sup>2</sup> / 10 ... 6 AWG
Note (conductor cross-section)	Depending on the conductor characteristic, a conductor with a smaller cross-section can also be inserted via push-in termination.
Strip length	18 ... 20 mm / 0.71 ... 0.79 inches
Wiring direction	Front-entry wiring

### Connection 2

Actuation type 2	Operating tool
------------------	----------------

### Physical data

Width	12 mm / 0.472 inches
Height	91.5 mm / 3.602 inches
Depth from upper-edge of DIN-rail	36.9 mm / 1.453 inches

### Mechanical Data

Mounting type	DIN-35 rail
Marking level	Center/side marking

### Material Data

Note (material data)	Information on material specifications can be found here
Color	blue

Subject to changes. Please also observe the further product documentation!

Material group	I
Insulation material	Polyamide (PA66)
Flammability class per UL94	V0
Fire load	0.65 MJ
Weight	32.2 g

### Environmental requirements

Processing temperature	-35 ... +85 °C
Continuous operating temperature	-60 ... +105 °C

### Commercial data



eCl@ss 10.0	27-14-11-20
eCl@ss 9.0	27-14-11-20
ETIM 8.0	EC000897
ETIM 7.0	EC000897
PU (SPU)	20 pcs
Packaging type	box
Country of origin	DE
GTIN	4055143754439
Customs tariff number	85369010000

### Environmental Product Compliance



RoHS Compliance Status	Compliant, No Exemption
------------------------	-------------------------

### Approvals / Certificates



#### General approvals

Logo	Approval	Additional Approval Text	Certificate name
	CCA DEKRA Certification B.V.	EN 60947	NTR NL 7675
	CCC CNEX	GB/T 3836.3	2020312313000183 (Ex eb IIC Gb, Ex eb I Mb)
	CSA DEKRA Certification B.V.	C22.2	70175104





Subject to changes. Please also observe the further product documentation!

	cURus Underwriters Laboratories Inc.	UL 1059	E45172
	KEMA/KEUR DEKRA Certification B.V.	EN 60947	71-103140

## Declarations of conformity and manufacturer's declarations

Logo	Approval	Additional Approval Text	Certificate name
	EU-Declaration of Conformity WAGO GmbH & Co. KG	-	-
	UK-Declaration of Conformity WAGO GmbH & Co. KG	-	-

## Approvals for marine applications

Logo	Approval	Additional Approval Text	Certificate name
	ABS American Bureau of Shipping	-	19- HG1866350- PDA
	BV Bureau Veritas S.A.	IEC 60947	58186/A0 BV
	DNV GL Det Norske Veritas, Germanischer Lloyd	-	TAE00003JT
	LR Lloyds Register	-	19/20050

## Approvals for hazardous areas

Logo	Approval	Additional Approval Text	Certificate name
------	----------	--------------------------	------------------

Subject to changes. Please also observe the further product documentation!

WAGO GmbH & Co. KG  
Hansastr. 27  
32423 Minden  
Phone: +49571 887-0 | Fax: +49571 887-169  
Email: [info.de@wago.com](mailto:info.de@wago.com) | Web: [www.wago.com](http://www.wago.com)



Do you have any questions about our products?  
We are always happy to take your call at +49 (571) 887-44222.

	<b>AEx</b> UL International Germany GmbH c/o Physikalisch Technische Bundesanstalt	UL 60079	E185892
	<b>ATEX</b> Physikalisch Technische Bundesanstalt	EN 60079-0	PTB ATEX 1012 U (II 2 G Ex eb IIC Gb bzw. I M 2 Ex eb I Mb)
	<b>CCC</b> CNEX	GB/T 3836.3	2020312313000183 (Ex eb IIC Gb, Ex eb I Mb)
	<b>EAC</b> Brjansker Zertifizierungsstelle	TP TC 012/2011	RU C-DE.AM02.B. 00127/19 (Ex e IIC Gb U)
	<b>IECEX</b> Physikalisch Technische Bundesanstalt	IEC 60079-0	IECEX PTB 18.0019U (Ex eb IIC Gb and Ex eb I Mb)
	<b>INMETRO</b> TÜV Rheinland do Brasil Ltda.	IEC 60079	TÜV 19.0819 U

## Required accessories

### End plate

End plate

	<b>Item no.: 2116-1291</b> End and intermediate plate; 1 mm thick; gray	<a href="http://www.wago.com/2116-1291">www.wago.com/2116-1291</a>
	<b>Item no.: 2116-1292</b> End and intermediate plate; 1 mm thick; orange	<a href="http://www.wago.com/2116-1292">www.wago.com/2116-1292</a>

## Optional accessories

### Mounting

Cover carrier

	<b>Item no.: 709-169</b> Cover carrier; Type 3; gray	<a href="http://www.wago.com/709-169">www.wago.com/709-169</a>
Cover		

Subject to changes. Please also observe the further product documentation!



**Item no.: 709-156**  
Cover; Type 3; suitable for cover carrier, type 3; 1 m long; transparent

[www.wago.com/709-156](http://www.wago.com/709-156)

**Protective warning marker**

Cover



**Item no.: 2016-115**  
Protective warning marker; for 5 terminal blocks; with high-voltage symbol, black; yellow

[www.wago.com/2016-115](http://www.wago.com/2016-115)

**Tool**

Operating tool



**Item no.: 210-721**  
Operating tool; Blade: 5.5 x 0.8 mm; with a partially insulated shaft; multicoloured

[www.wago.com/210-721](http://www.wago.com/210-721)

**Jumpers**

Jumper



**Item no.: 2016-402**  
Jumper; 2-way; insulated; light gray

[www.wago.com/2016-402](http://www.wago.com/2016-402)



**Item no.: 2016-405/011-000**  
Star point jumper; 3-way; insulated; light gray

[www.wago.com/2016-405/011-000](http://www.wago.com/2016-405/011-000)



**Item no.: 2016-434**  
Jumper; from 1 to 4; insulated; light gray

[www.wago.com/2016-434](http://www.wago.com/2016-434)



**Item no.: 2016-404**  
Jumper; 4-way; insulated; light gray

[www.wago.com/2016-404](http://www.wago.com/2016-404)



**Item no.: 2016-405**  
Jumper; 5-way; insulated; light gray

[www.wago.com/2016-405](http://www.wago.com/2016-405)



**Item no.: 2016-435**  
Jumper; from 1 to 5; insulated; light gray

[www.wago.com/2016-435](http://www.wago.com/2016-435)



**Item no.: 2016-403**  
Jumper; 3-way; insulated; light gray

[www.wago.com/2016-403](http://www.wago.com/2016-403)



**Item no.: 2016-433**  
Jumper; from 1 to 3; insulated; light gray

[www.wago.com/2016-433](http://www.wago.com/2016-433)

**Testing and measuring**

Testing accessories



**Item no.: 2009-174**  
Test plug adapter; for 4 mm Ø test plugs; for testing TOPJOB®S rail-mounted terminal blocks; gray

[www.wago.com/2009-174](http://www.wago.com/2009-174)

Subject to changes. Please also observe the further product documentation!



**Item no.: 2009-182**

Testing tap; for max. 2.5 mm<sup>2</sup>; tool-free connection for individual test wires 0.08 - 2.5 mm; gray

[www.wago.com/2009-182](http://www.wago.com/2009-182)



**Item no.: 2016-511**

Modular TOPJOB®S connector; modular; for jumper contact slot; 1-pole; 4,00 mm<sup>2</sup>; gray

[www.wago.com/2016-511](http://www.wago.com/2016-511)



**Item no.: 2016-549**

Spacer module; modular; e.g., for bridging commoned terminal blocks; gray

[www.wago.com/2016-549](http://www.wago.com/2016-549)



**Item no.: 210-136**

Test plug; 2 mm Ø; with 500 mm cable; red

[www.wago.com/210-136](http://www.wago.com/210-136)

## Carrier rail

### Mounting accessories



**Item no.: 210-197**

Steel carrier rail; 35 x 15 mm; 1.5 mm thick; 2 m long; slotted; similar to EN 60715; silver-colored

[www.wago.com/210-197](http://www.wago.com/210-197)



**Item no.: 210-198**

Copper carrier rail; 35 x 15 mm; 2.3 mm thick; 2 m long; unslotted; according to EN 60715; copper-colored

[www.wago.com/210-198](http://www.wago.com/210-198)



**Item no.: 210-113**

Steel carrier rail; 35 x 7.5 mm; 1 mm thick; 2 m long; unslotted; according to EN 60715; silver-colored

[www.wago.com/210-113](http://www.wago.com/210-113)



**Item no.: 210-118**

Steel carrier rail; 35 x 15 mm; 2.3 mm thick; 2 m long; unslotted; according to EN 60715; silver-colored

[www.wago.com/210-118](http://www.wago.com/210-118)



**Item no.: 210-112**

Steel carrier rail; 35 x 7.5 mm; 1 mm thick; 2 m long; slotted; according to EN 60715; "Hole width 25 mm; silver-colored

[www.wago.com/210-112](http://www.wago.com/210-112)



**Item no.: 210-114**

Steel carrier rail; 35 x 15 mm; 1.5 mm thick; 2 m long; unslotted; similar to EN 60715; silver-colored

[www.wago.com/210-114](http://www.wago.com/210-114)



**Item no.: 210-115**

Steel carrier rail; 35 x 7.5 mm; 1 mm thick; 2 m long; slotted; according to EN 60715; "Hole width 18 mm; silver-colored

[www.wago.com/210-115](http://www.wago.com/210-115)

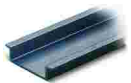

**Item no.: 210-196**

Aluminum carrier rail; 35 x 8.2 mm; 1.6 mm thick; 2 m long; unslotted; similar to EN 60715; silver-colored

[www.wago.com/210-196](http://www.wago.com/210-196)

## Ferrule

### Ferrule



**Item no.: 216-210**

Ferrule; Sleeve for 16 mm<sup>2</sup> / AWG 6; insulated; electro-tin plated; electrolytic copper; gastight crimped; acc. to DIN 46228, Part 4/09.90; blue

[www.wago.com/216-210](http://www.wago.com/216-210)



**Item no.: 216-284**

Ferrule; Sleeve for 1.5 mm<sup>2</sup> / AWG 16; insulated; electro-tin plated; electrolytic copper; gastight

[www.wago.com/216-284](http://www.wago.com/216-284)

Subject to changes. Please also observe the further product documentation!

WAGO GmbH & Co. KG

Hansastr. 27

32423 Minden

Phone: +49571 887-0 | Fax: +49571 887-169

Email: [info.de@wago.com](mailto:info.de@wago.com) | Web: [www.wago.com](http://www.wago.com)

Do you have any questions about our products?

We are always happy to take your call at +49 (571) 887-44222.



crimped; acc. to DIN 46228, Part 4/09.90; black

**Item no.: 216-286**

Ferrule; Sleeve for 2.5 mm<sup>2</sup> / AWG 14; insulated; electro-tin plated; electrolytic copper; gastight crimped; acc. to DIN 46228, Part 4/09.90; blue

[www.wago.com/216-286](http://www.wago.com/216-286)

**Item no.: 216-287**

Ferrule; Sleeve for 4 mm<sup>2</sup> / AWG 12; insulated; electro-tin plated; electrolytic copper; gastight crimped; acc. to DIN 46228, Part 4/09.90; gray

[www.wago.com/216-287](http://www.wago.com/216-287)

**Item no.: 216-288**

Ferrule; Sleeve for 6 mm<sup>2</sup> / AWG 10; insulated; electro-tin plated; electrolytic copper; gastight crimped; acc. to DIN 46228, Part 4/09.90; yellow

[www.wago.com/216-288](http://www.wago.com/216-288)

**Item no.: 216-289**

Ferrule; Sleeve for 10 mm<sup>2</sup> / AWG 8; insulated; electro-tin plated; electrolytic copper; gastight crimped; acc. to DIN 46228, Part 4/09.90; red

[www.wago.com/216-289](http://www.wago.com/216-289)

**Cover**

## Cover

**Item no.: 2016-100**

Finger guard; touchproof cover protects unused conductor entries; yellow

[www.wago.com/2016-100](http://www.wago.com/2016-100)

**Marking accessories**

## Marking strip

**Item no.: 2009-110**

Marking strips; for Smart Printer; on reel; not stretchable; plain; snap-on type; white

[www.wago.com/2009-110](http://www.wago.com/2009-110)

## Marker carrier

**Item no.: 2009-198**

Adaptor; gray

[www.wago.com/2009-198](http://www.wago.com/2009-198)

## Marker

**Item no.: 2009-115/000-002**

WMB-Inline; for Smart Printer; 1500 pieces on roll; stretchable 5 - 5.2 mm; plain; snap-on type; yellow

[www.wago.com/2009-115/000-002](http://www.wago.com/2009-115/000-002)

**Item no.: 2009-115/000-007**

WMB-Inline; for Smart Printer; 1500 pieces on roll; stretchable 5 - 5.2 mm; plain; snap-on type; gray

[www.wago.com/2009-115/000-007](http://www.wago.com/2009-115/000-007)

**Item no.: 2009-115/000-017**

WMB-Inline; for Smart Printer; 1500 pieces on roll; stretchable 5 - 5.2 mm; plain; snap-on type; light green

[www.wago.com/2009-115/000-017](http://www.wago.com/2009-115/000-017)

**Item no.: 2009-115/000-023**

WMB-Inline; for Smart Printer; 1500 pieces on roll; stretchable 5 - 5.2 mm; plain; snap-on type; green

[www.wago.com/2009-115/000-023](http://www.wago.com/2009-115/000-023)

**Item no.: 2009-115/000-024**

WMB-Inline; for Smart Printer; 1500 pieces on roll; stretchable 5 - 5.2 mm; plain; snap-on type; violet

[www.wago.com/2009-115/000-024](http://www.wago.com/2009-115/000-024)

Subject to changes. Please also observe the further product documentation!

WAGO GmbH & Co. KG

Hansastr. 27

32423 Minden

Phone: +49571 887-0 | Fax: +49571 887-169

Email: [info.de@wago.com](mailto:info.de@wago.com) | Web: [www.wago.com](http://www.wago.com)

Do you have any questions about our products?

We are always happy to take your call at +49 (571) 887-44222.

**Item no.: 2009-145/000-006**

Mini-WSB Inline; for Smart Printer; 1700 pieces on roll; stretchable 5 - 5.2 mm; plain; snap-on type; blue

[www.wago.com/2009-145/000-006](http://www.wago.com/2009-145/000-006)

**Item no.: 2009-145**

Mini-WSB Inline; for Smart Printer; 1700 pieces on roll; stretchable 5 - 5.2 mm; plain; snap-on type; white

[www.wago.com/2009-145](http://www.wago.com/2009-145)

**Item no.: 2009-145/000-002**

Mini-WSB Inline; for Smart Printer; 1700 pieces on roll; stretchable 5 - 5.2 mm; plain; snap-on type; yellow

[www.wago.com/2009-145/000-002](http://www.wago.com/2009-145/000-002)

**Item no.: 2009-145/000-007**

Mini-WSB Inline; for Smart Printer; 1700 pieces on roll; stretchable 5 - 5.2 mm; plain; snap-on type; gray

[www.wago.com/2009-145/000-007](http://www.wago.com/2009-145/000-007)

**Item no.: 2009-145/000-005**

Mini-WSB Inline; for Smart Printer; 1700 pieces on roll; stretchable 5 - 5.2 mm; plain; snap-on type; red

[www.wago.com/2009-145/000-005](http://www.wago.com/2009-145/000-005)

**Item no.: 2009-145/000-012**

Mini-WSB Inline; for Smart Printer; 1700 pieces on roll; stretchable 5 - 5.2 mm; plain; snap-on type; orange

[www.wago.com/2009-145/000-012](http://www.wago.com/2009-145/000-012)

**Item no.: 2009-145/000-023**

Mini-WSB Inline; for Smart Printer; 1700 pieces on roll; stretchable 5 - 5.2 mm; plain; snap-on type; green

[www.wago.com/2009-145/000-023](http://www.wago.com/2009-145/000-023)

**Item no.: 2009-145/000-024**

Mini-WSB Inline; for Smart Printer; 1700 pieces on roll; stretchable 5 - 5.2 mm; plain; snap-on type; violet

[www.wago.com/2009-145/000-024](http://www.wago.com/2009-145/000-024)



**Item no.: 2009-115**

WMB-Inline; for Smart Printer; 1500 pieces on roll; stretchable 5 - 5.2 mm; plain; snap-on type; white

[www.wago.com/2009-115](http://www.wago.com/2009-115)



**Item no.: 248-501/000-006**

Mini-WSB marking card; as card; not stretchable; plain; snap-on type; blue

[www.wago.com/248-501/000-006](http://www.wago.com/248-501/000-006)



**Item no.: 248-501/000-007**

Mini-WSB marking card; as card; not stretchable; plain; snap-on type; gray

[www.wago.com/248-501/000-007](http://www.wago.com/248-501/000-007)



**Item no.: 248-501/000-002**

Mini-WSB marking card; as card; not stretchable; plain; snap-on type; yellow

[www.wago.com/248-501/000-002](http://www.wago.com/248-501/000-002)

Subject to changes. Please also observe the further product documentation!

WAGO GmbH & Co. KG

Hansastr. 27

32423 Minden

Phone: +49571 887-0 | Fax: +49571 887-169

Email: [info.de@wago.com](mailto:info.de@wago.com) | Web: [www.wago.com](http://www.wago.com)

Do you have any questions about our products?

We are always happy to take your call at +49 (571) 887-44222.



**Item no.: 248-501/000-012**  
Mini-WSB marking card; as card; not stretchable; plain; snap-on type; orange

[www.wago.com/248-501/000-012](http://www.wago.com/248-501/000-012)



**Item no.: 248-501**  
Mini-WSB marking card; as card; not stretchable; plain; snap-on type; white

[www.wago.com/248-501](http://www.wago.com/248-501)



**Item no.: 248-501/000-017**  
Mini-WSB marking card; as card; not stretchable; plain; snap-on type; light green

[www.wago.com/248-501/000-017](http://www.wago.com/248-501/000-017)



**Item no.: 248-501/000-005**  
Mini-WSB marking card; as card; not stretchable; plain; snap-on type; red

[www.wago.com/248-501/000-005](http://www.wago.com/248-501/000-005)



**Item no.: 248-501/000-024**  
Mini-WSB marking card; as card; not stretchable; plain; snap-on type; violet

[www.wago.com/248-501/000-024](http://www.wago.com/248-501/000-024)



**Item no.: 248-501/000-023**  
Mini-WSB marking card; as card; not stretchable; plain; snap-on type; green

[www.wago.com/248-501/000-023](http://www.wago.com/248-501/000-023)



**Item no.: 793-5501/000-007**  
WMB marking card; as card; for terminal block width 5 - 17.5 mm; stretchable 5 - 5.2 mm; plain; snap-on type; gray

[www.wago.com/793-5501/000-007](http://www.wago.com/793-5501/000-007)



**Item no.: 793-5501/000-012**  
WMB marking card; as card; for terminal block width 5 - 17.5 mm; stretchable 5 - 5.2 mm; plain; snap-on type; orange

[www.wago.com/793-5501/000-012](http://www.wago.com/793-5501/000-012)



**Item no.: 793-5501/000-017**  
WMB marking card; as card; for terminal block width 5 - 17.5 mm; stretchable 5 - 5.2 mm; plain; snap-on type; light green

[www.wago.com/793-5501/000-017](http://www.wago.com/793-5501/000-017)

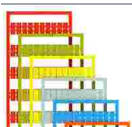

**Item no.: 793-5501/000-023**  
WMB marking card; as card; for terminal block width 5 - 17.5 mm; stretchable 5 - 5.2 mm; plain; snap-on type; green

[www.wago.com/793-5501/000-023](http://www.wago.com/793-5501/000-023)

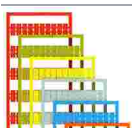

**Item no.: 793-5501/000-024**  
WMB marking card; as card; for terminal block width 5 - 17.5 mm; stretchable 5 - 5.2 mm; plain; snap-on type; violet

[www.wago.com/793-5501/000-024](http://www.wago.com/793-5501/000-024)

Subject to changes. Please also observe the further product documentation!



**Item no.: 793-501/000-002**  
WMB marking card; as card; not stretchable; plain; snap-on type; yellow

[www.wago.com/793-501/000-002](http://www.wago.com/793-501/000-002)



**Item no.: 793-501/000-007**  
WMB marking card; as card; not stretchable; plain; snap-on type; gray

[www.wago.com/793-501/000-007](http://www.wago.com/793-501/000-007)



**Item no.: 793-501/000-017**  
WMB marking card; as card; not stretchable; plain; snap-on type; light green

[www.wago.com/793-501/000-017](http://www.wago.com/793-501/000-017)



**Item no.: 793-501/000-012**  
WMB marking card; as card; not stretchable; plain; snap-on type; orange

[www.wago.com/793-501/000-012](http://www.wago.com/793-501/000-012)



**Item no.: 793-501/000-023**  
WMB marking card; as card; not stretchable; plain; snap-on type; green

[www.wago.com/793-501/000-023](http://www.wago.com/793-501/000-023)



**Item no.: 793-501/000-006**  
WMB marking card; as card; not stretchable; plain; snap-on type; blue

[www.wago.com/793-501/000-006](http://www.wago.com/793-501/000-006)



**Item no.: 793-501/000-005**  
WMB marking card; as card; not stretchable; plain; snap-on type; red

[www.wago.com/793-501/000-005](http://www.wago.com/793-501/000-005)



**Item no.: 793-501**  
WMB marking card; as card; not stretchable; plain; snap-on type; white

[www.wago.com/793-501](http://www.wago.com/793-501)



**Item no.: 793-501/000-024**  
WMB marking card; as card; not stretchable; plain; snap-on type; violet

[www.wago.com/793-501/000-024](http://www.wago.com/793-501/000-024)

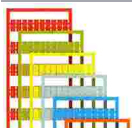

**Item no.: 793-5501/000-005**  
WMB marking card; as card; for terminal block width 5 - 17.5 mm; stretchable 5 - 5.2 mm; plain; snap-on type; red

[www.wago.com/793-5501/000-005](http://www.wago.com/793-5501/000-005)

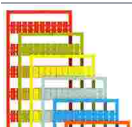

**Item no.: 793-5501/000-002**  
WMB marking card; as card; for terminal block width 5 - 17.5 mm; stretchable 5 - 5.2 mm; plain; snap-on type; yellow

[www.wago.com/793-5501/000-002](http://www.wago.com/793-5501/000-002)

Subject to changes. Please also observe the further product documentation!



**Item no.:** 793-5501/000-006

WMB marking card; as card; for terminal block width 5 - 17.5 mm; stretchable 5 - 5.2 mm; plain; snap-on type; blue [www.wago.com/793-5501/000-006](http://www.wago.com/793-5501/000-006)



**Item no.:** 793-5501

WMB marking card; as card; for terminal block width 5 - 17.5 mm; stretchable 5 - 5.2 mm; plain; snap-on type; white [www.wago.com/793-5501](http://www.wago.com/793-5501)



**Item no.:** 2009-115/000-012

WMB-Inline; for Smart Printer; 1500 pieces on roll; stretchable 5 - 5.2 mm; plain; snap-on type; orange [www.wago.com/2009-115/000-012](http://www.wago.com/2009-115/000-012)



**Item no.:** 2009-115/000-006

WMB-Inline; for Smart Printer; 1500 pieces on roll; stretchable 5 - 5.2 mm; plain; snap-on type; blue [www.wago.com/2009-115/000-006](http://www.wago.com/2009-115/000-006)

Group marker carrier



**Item no.:** 2009-193

Group marker carrier; gray [www.wago.com/2009-193](http://www.wago.com/2009-193)



**Item no.:** 2009-192

Group marker carrier; gray [www.wago.com/2009-192](http://www.wago.com/2009-192)



**Item no.:** 2009-191

Group marker carrier; gray [www.wago.com/2009-191](http://www.wago.com/2009-191)

**Downloads**

**Documentation**

**Bid Text**

2116-1204 docx - Datei	2019 Apr 15	docx 15.1 kB	Download
2116-1204 X81 - Datei	2019 Apr 15	xml 4.0 kB	Download

**Additional Information**

Technical Section Technical explanations	pdf 2.2 MB	Download
---	---------------	----------

**CAD/CAE-Data**

**CAD data**

2D/3D Models 2116-1204	URL	Download
------------------------	-----	----------

Subject to changes. Please also observe the further product documentation!

## CAE data

EPLAN Data Portal 2116-1204

URL

Download

ZUKEN Portal 2116-1204

URL

Download

## Environmental Product Compliance

### Compliance Search

Environmental Product Compliance 2116-1204

URL

Download

2-conductor through terminal block; with lever and Push-in CAGE CLAMP®; 16 mm<sup>2</sup>; with test port; suitable for Ex i applications; side and center marking; for DIN-rail 35 x 15 and 35 x 7.5; Push-in CAGE CLAMP®; 16,00 mm<sup>2</sup>; blue

## Installation Notes

### Conductor termination

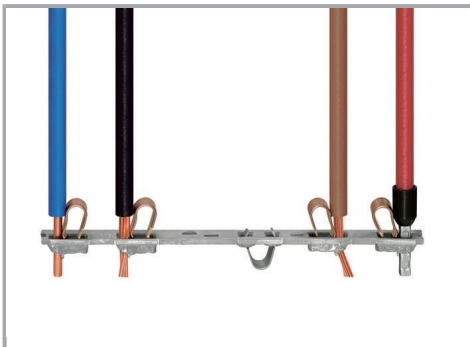

All conductor types at a glance

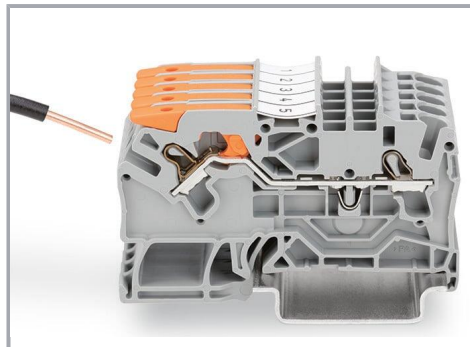

Push-in termination of solid conductors

Subject to changes. Please also observe the further product documentation!

WAGO GmbH & Co. KG

Hansastr. 27

32423 Minden

Phone: +49571 887-0 | Fax: +49571 887-169

Email: [info.de@wago.com](mailto:info.de@wago.com) | Web: [www.wago.com](http://www.wago.com)

Do you have any questions about our products?

We are always happy to take your call at +49 (571) 887-44222.

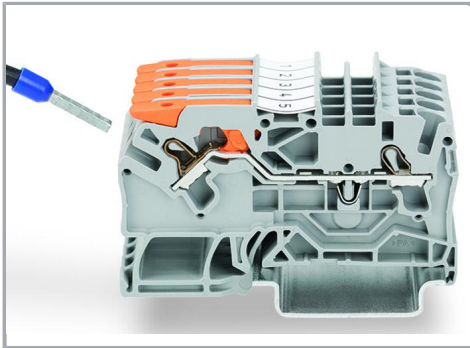

Push-in termination of fine-stranded conductors with ferrules

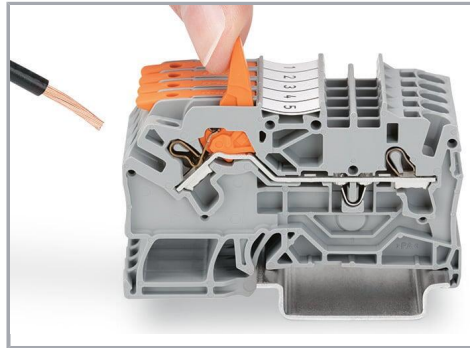

Pull the lever up until it stops, then connect the fine-stranded conductor.

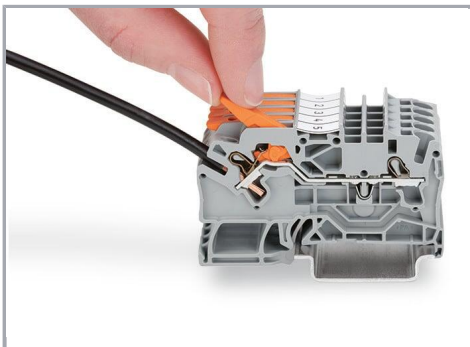

Push the lever back down – done!

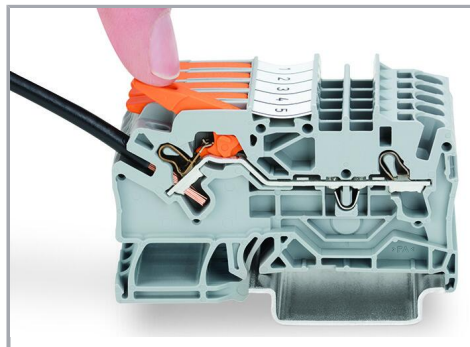

Push the lever back down – done!

### Commoning



Insert a push-in type jumper bar and push down until it hits the backstop.

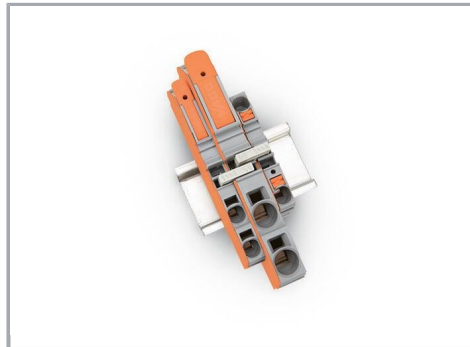

Commoning with step-down jumpers.

### Testing

Subject to changes. Please also observe the further product documentation!



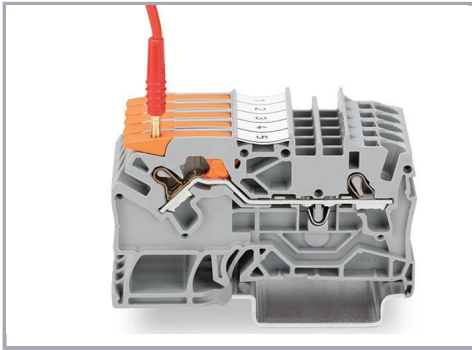

Testing with a 2 mm Ø test plug (max. 42 V).

### Marking

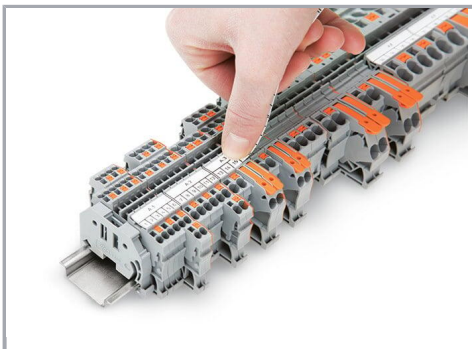

Snapping a marking strip into a marker slot.



Snapping a marking strip into the marker slot.

### Product family

#### TOPJOB® S

TOPJOB® S: In various industrial applications and modern building installations, WAGO's wide and versatile range of rail-mount terminal blocks provides more than just reliable electrical connections.

[Show all products from the family](#)

Subject to changes. Please also observe the further product documentation!