

## Fast Soft Recovery Rectifier Diode, 60 A

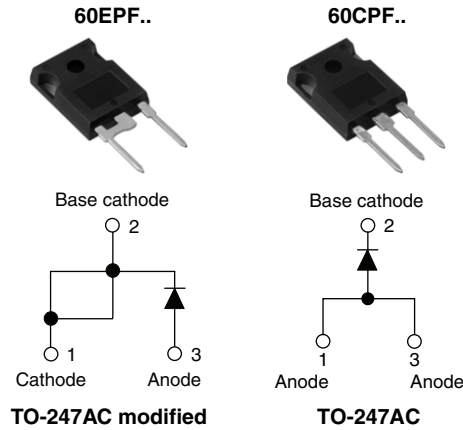

### FEATURES/DESCRIPTION

The 60EPF.. and 60CPF.. fast soft recovery rectifier series has been optimized for combined short reverse recovery time and low forward voltage drop.

The glass passivation ensures stable reliable operation in the most severe temperature and power cycling conditions.

This product series has been designed and qualified for industrial level.

### APPLICATIONS

- Output rectification and freewheeling in inverters, choppers and converters
- Input rectifications where severe restrictions on conducted EMI should be met

| PRODUCT SUMMARY |                |
|-----------------|----------------|
| $V_F$ at 30 A   | < 1.1 V        |
| $t_{rr}$        | 70 ns          |
| $V_{RRM}$       | 200 V to 600 V |

| MAJOR RATINGS AND CHARACTERISTICS |                                |             |                  |
|-----------------------------------|--------------------------------|-------------|------------------|
| SYMBOL                            | CHARACTERISTICS                | VALUES      | UNITS            |
| $V_{RRM}$                         |                                | 200 to 600  | V                |
| $I_{F(AV)}$                       | Sinusoidal waveform            | 60          | A                |
| $I_{FSM}$                         |                                | 830         |                  |
| $t_{rr}$                          | 1 A, 100 A/ $\mu$ s            | 70          | ns               |
| $V_F$                             | 30 A, $T_J = 25^\circ\text{C}$ | 1.1         | V                |
| $T_J$                             |                                | - 40 to 150 | $^\circ\text{C}$ |

| VOLTAGE RATINGS  |   |  |   |
|------------------|---|--|---|
| PART NUMBER      | $V_{RRM}$ , MAXIMUM PEAK REVERSE VOLTAGE<br>V | $V_{RSM}$ , MAXIMUM NON-REPETITIVE PEAK REVERSE VOLTAGE<br>V | $I_{RRM}$ AT 150 $^\circ\text{C}$<br>mA |
| 60EPF02, 60CPF02 | 200   | 300  | 5                                       |
| 60EPF04, 60CPF04 | 400   | 500  |   |
| 60EPF06, 60CPF06 | 600   | 700  |   |

| ABSOLUTE MAXIMUM RATINGS                            |               |  |        |                             |
|---|---------------|--|--------|-----------------------------|
| PARAMETER   | SYMBOL        | TEST CONDITIONS  | VALUES | UNITS                       |
| Maximum average forward current                     | $I_{F(AV)}$   | $T_C = 106^\circ\text{C}$ , 180 $^\circ$ conduction half sine wave | 60     | A                           |
| Maximum peak one cycle non-repetitive surge current | $I_{FSM}$     | 10 ms sine pulse, rated $V_{RRM}$ applied                          | 700    |                             |
|   |               | 10 ms sine pulse, no voltage reapplied                             | 830    |                             |
| Maximum $I^2t$ for fusing                           | $I^2t$        | 10 ms sine pulse, rated $V_{RRM}$ applied                          | 2450   | $\text{A}^2\text{s}$        |
|   |               | 10 ms sine pulse, no voltage reapplied                             | 3460   |                             |
| Maximum $I^2\sqrt{t}$ for fusing                    | $I^2\sqrt{t}$ | $t = 0.1$ ms to 10 ms, no voltage reapplied                        | 34 600 | $\text{A}^2\sqrt{\text{s}}$ |

# 60EPF.., 60CPF.. Soft Recovery Series



Vishay High Power Products

Fast Soft Recovery  
Rectifier Diode, 60 A

| ELECTRICAL SPECIFICATIONS       |             |  |                               |        |           |
|---------------------------------|-------------|--|-------------------------------|--------|-----------|
| PARAMETER                       | SYMBOL      | TEST CONDITIONS                        |                               | VALUES | UNITS     |
| Maximum forward voltage drop    | $V_{FM}$    | 60 A, $T_J = 25\text{ }^\circ\text{C}$ |                               | 1.3    | V         |
| Forward slope resistance        | $r_t$       | $T_J = 150\text{ }^\circ\text{C}$      |                               | 5.0    | $m\Omega$ |
| Threshold voltage               | $V_{F(TO)}$ |  |                               | 0.88   | V         |
| Maximum reverse leakage current | $I_{RM}$    | $T_J = 25\text{ }^\circ\text{C}$       | $V_R = \text{Rated } V_{RRM}$ | 0.1    | mA        |
|                                 |             | $T_J = 150\text{ }^\circ\text{C}$      |                               | 5.0    |           |

| RECOVERY CHARACTERISTICS |          |  |        |               |  |
|--------------------------|----------|--|--------|---------------|--|
| PARAMETER                | SYMBOL   | TEST CONDITIONS  | VALUES | UNITS         |  |
| Reverse recovery time    | $t_{rr}$ | $I_F$ at 60 Apk<br>25 A/ $\mu\text{s}$<br>$25\text{ }^\circ\text{C}$ | 180    | ns            |  |
| Reverse recovery current | $I_{rr}$ |  | 3.4    | A             |  |
| Reverse recovery charge  | $Q_{rr}$ |  | 0.5    | $\mu\text{C}$ |  |
| Snap factor              | S        | Typical  | 0.5    |               |  |

| THERMAL - MECHANICAL SPECIFICATIONS             |                |                                      |                  |                        |
|---|----------------|--------------------------------------|------------------|------------------------|
| PARAMETER                                       | SYMBOL         | TEST CONDITIONS                      | VALUES           | UNITS                  |
| Maximum junction and storage temperature range  | $T_J, T_{Stg}$ |                                      | - 40 to 150      | $^\circ\text{C}$       |
| Maximum thermal resistance, junction to case    | $R_{thJC}$     | DC operation                         | 0.4              | $^\circ\text{C/W}$     |
| Maximum thermal resistance, junction to ambient | $R_{thJA}$     |                                      | 40               |                        |
| Typical thermal resistance, case to heatsink    | $R_{thCS}$     | Mounting surface, smooth and greased | 0.2              |                        |
| Approximate weight                              |                |                                      | 6                | g                      |
|   |                |                                      | 0.21             | oz.                    |
| Mounting torque                                 | minimum        |                                      | 6 (5)            | kgf · cm<br>(lbf · in) |
|   | maximum        |                                      | 12 (10)          |                        |
| Marking device                                  |                | Case style TO-247AC modified (JEDEC) | 60EPF02, 60CPF02 |                        |
|   |                |                                      | 60EPF04, 60CPF04 |                        |
|   |                |                                      | 60EPF06, 60CPF06 |                        |



# 60EPF., 60CPF.. Soft Recovery Series

Fast Soft Recovery  
Rectifier Diode, 60 A

Vishay High Power Products

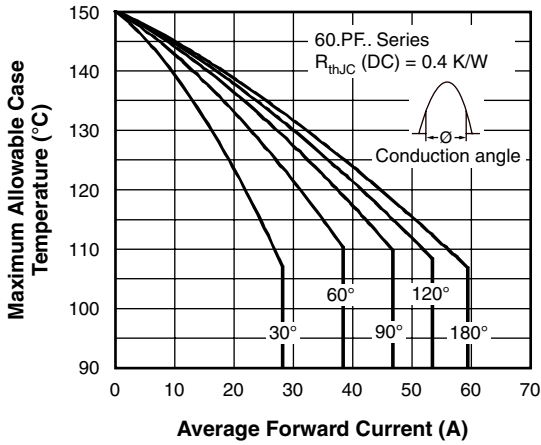

Fig. 1 - Current Rating Characteristics

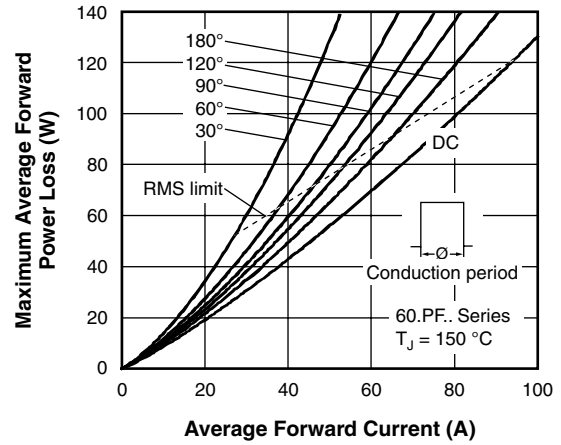

Fig. 4 - Forward Power Loss Characteristics

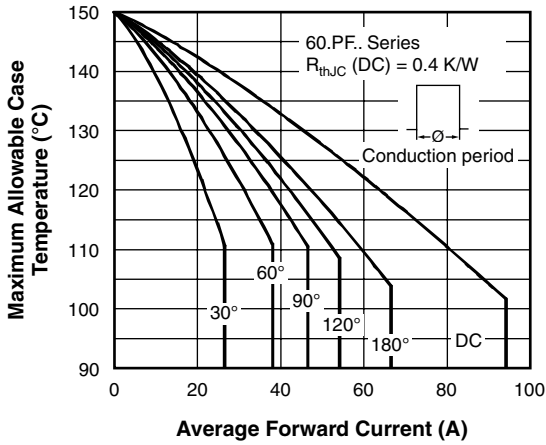

Fig. 2 - Current Rating Characteristics

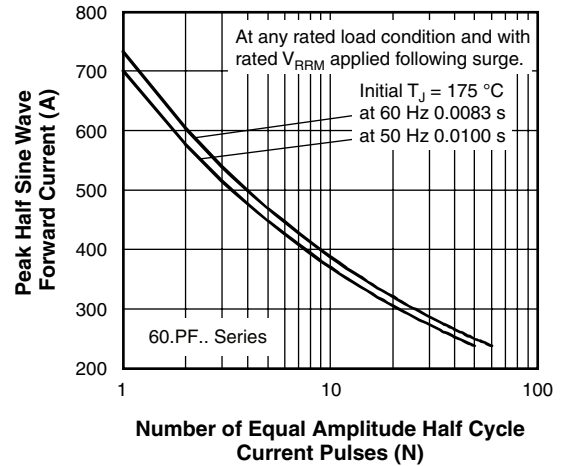

Fig. 5 - Maximum Non-Repetitive Surge Current

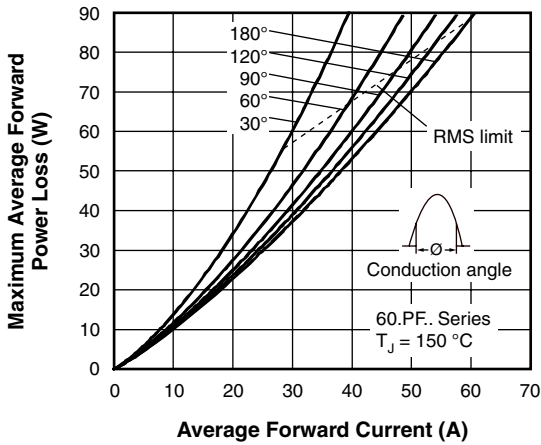

Fig. 3 - Forward Power Loss Characteristics

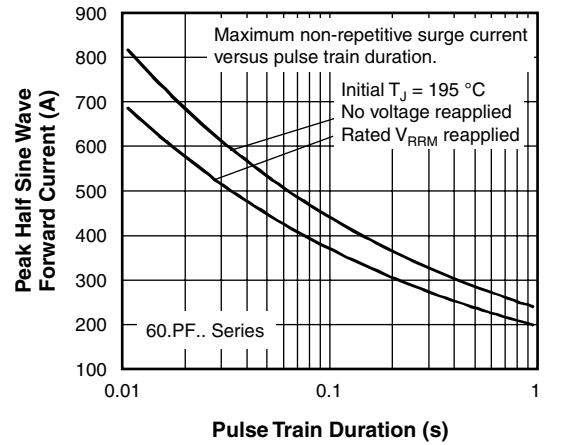

Fig. 6 - Maximum Non-Repetitive Surge Current

# 60EPF.., 60CPF.. Soft Recovery Series



Vishay High Power Products

Fast Soft Recovery Rectifier Diode, 60 A

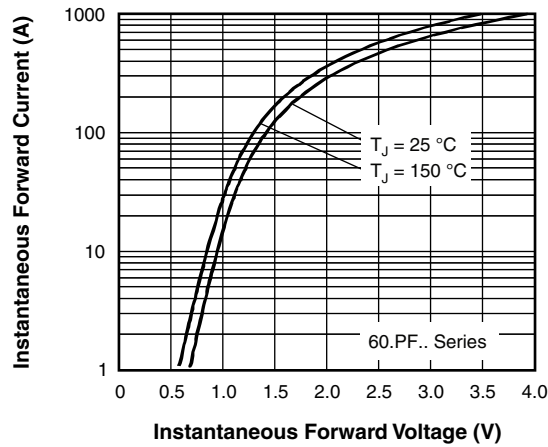

Fig. 7 - Forward Voltage Drop Characteristics

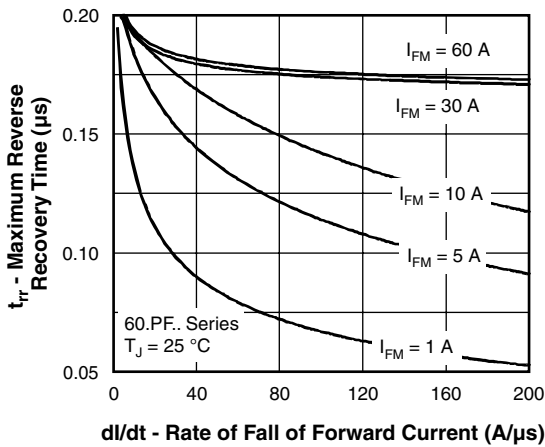

Fig. 8 - Recovery Time Characteristics,  $T_J = 25\text{ }^\circ\text{C}$

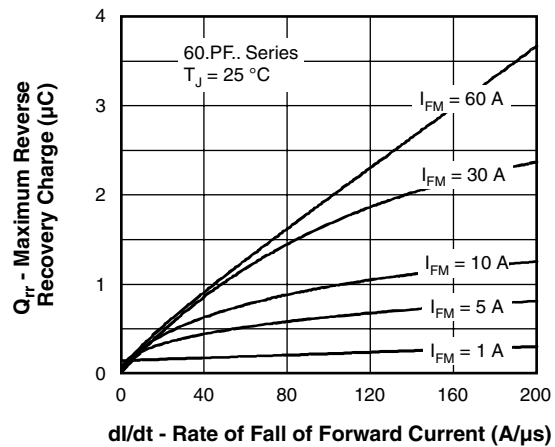

Fig. 10 - Recovery Charge Characteristics,  $T_J = 25\text{ }^\circ\text{C}$

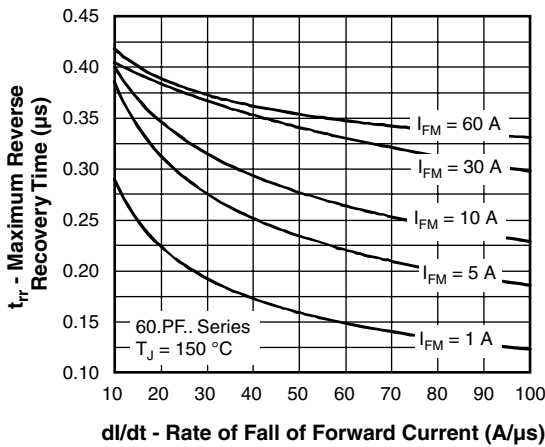

Fig. 9 - Recovery Time Characteristics,  $T_J = 150\text{ }^\circ\text{C}$

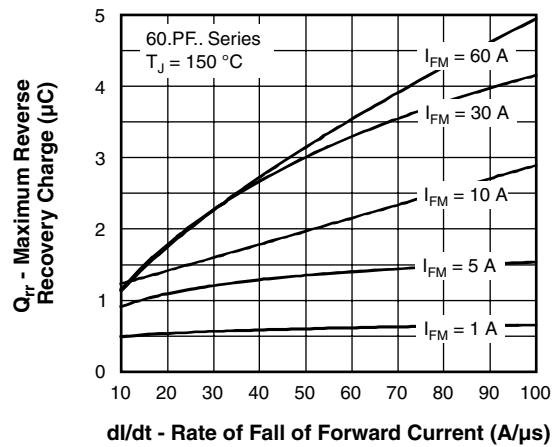

Fig. 11 - Recovery Charge Characteristics,  $T_J = 150\text{ }^\circ\text{C}$



# 60EPF., 60CPF.. Soft Recovery Series

Fast Soft Recovery  
Rectifier Diode, 60 A

Vishay High Power Products

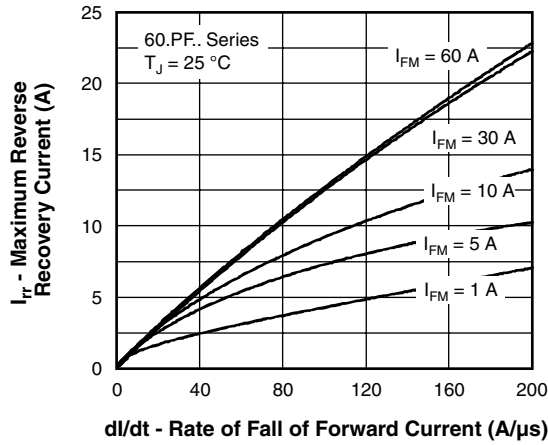

Fig. 12 - Recovery Current Characteristics,  $T_J = 25\text{ }^\circ\text{C}$

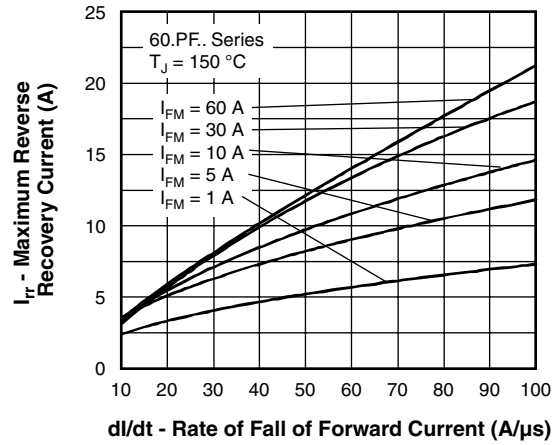

Fig. 13 - Recovery Current Characteristics,  $T_J = 150\text{ }^\circ\text{C}$

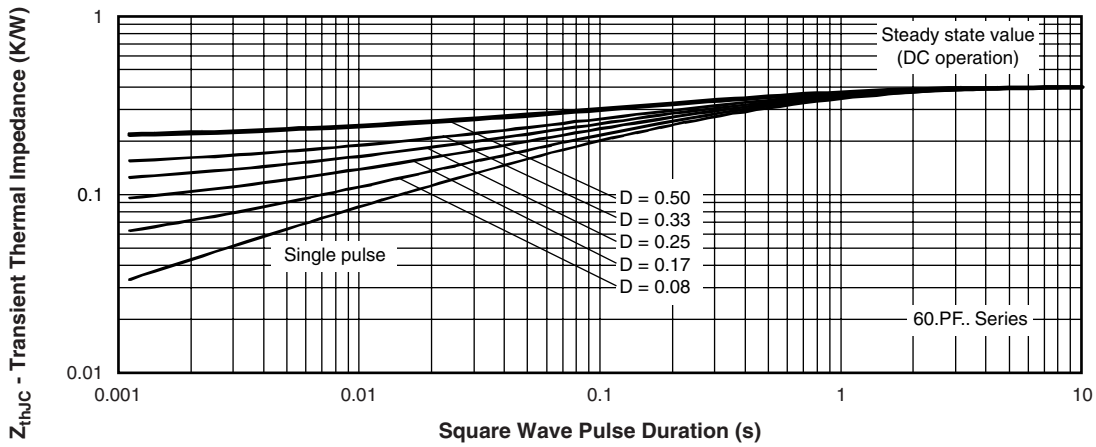

Fig. 14 - Thermal Impedance  $Z_{thJC}$  Characteristics

# 60EPF.., 60CPF.. Soft Recovery Series



Vishay High Power Products

Fast Soft Recovery  
Rectifier Diode, 60 A

## ORDERING INFORMATION TABLE

| Device code | 60 | E  | P | F | 06 | - |
|-------------|----|--|---|---|----|---|
|             | ①  | ②  | ③ | ④ | ⑤  | ⑥ |
| <b>1</b>    | -  | Current rating (60 = 60 A)   |   |   |    |   |
| <b>2</b>    | -  | Circuit configuration:<br>E = Single diode<br>C = Single diode, 3 pins |   |   |    |   |
| <b>3</b>    | -  | Package:<br>P = TO-247AC modified                                      |   |   |    |   |
| <b>4</b>    | -  | Type of silicon:<br>F = Fast recovery                                  |   |   |    |   |
| <b>5</b>    | -  | Voltage code x 100 = $V_{RRM}$   |   |   |    |   |
| <b>6</b>    | -  | • None = Standard production<br>• PbF = Lead (Pb)-free                 |   |   |    |   |

02 = 200 V  
04 = 400 V  
06 = 600 V

| LINKS TO RELATED DOCUMENTS |                   |  |
|----------------------------|-------------------|--|
| Dimensions                 | TO-247AC modified | <a href="http://www.vishay.com/doc?95253">www.vishay.com/doc?95253</a> |
|                            | TO-247AC          | <a href="http://www.vishay.com/doc?95223">www.vishay.com/doc?95223</a> |
| Part marking information   | TO-247AC modified | <a href="http://www.vishay.com/doc?95255">www.vishay.com/doc?95255</a> |
|                            | TO-247AC          | <a href="http://www.vishay.com/doc?95226">www.vishay.com/doc?95226</a> |
| SPICE model                |                   | <a href="http://www.vishay.com/doc?95275">www.vishay.com/doc?95275</a> |



## Disclaimer

All product specifications and data are subject to change without notice.

Vishay Intertechnology, Inc., its affiliates, agents, and employees, and all persons acting on its or their behalf (collectively, "Vishay"), disclaim any and all liability for any errors, inaccuracies or incompleteness contained herein or in any other disclosure relating to any product.

Vishay disclaims any and all liability arising out of the use or application of any product described herein or of any information provided herein to the maximum extent permitted by law. The product specifications do not expand or otherwise modify Vishay's terms and conditions of purchase, including but not limited to the warranty expressed therein, which apply to these products.

No license, express or implied, by estoppel or otherwise, to any intellectual property rights is granted by this document or by any conduct of Vishay.

The products shown herein are not designed for use in medical, life-saving, or life-sustaining applications unless otherwise expressly indicated. Customers using or selling Vishay products not expressly indicated for use in such applications do so entirely at their own risk and agree to fully indemnify Vishay for any damages arising or resulting from such use or sale. Please contact authorized Vishay personnel to obtain written terms and conditions regarding products designed for such applications.

Product names and markings noted herein may be trademarks of their respective owners.