



Dust and Splash proof  
Membrane Face Plate



# DX-35-ACA with RMS option

**5 Amp average AC or True RMS  
3 1/2 Digit with 0.56" or 0.8" LEDs  
in a 1/8 DIN Case**

Measuring AC current directly from industry standard 5 Amp CTs, this meter is the OEM's choice for modern switchboard installation and upgrades.

## General Features

The DX-35-ACA, a cost-effective, AC current measuring meter with a very low burden of 0.5VA respectively. Its internal shunt provides for direct connection to 5A CT's (current transformers). No matter what the CT ratio, the 15 turn, infinitely adjustable Span potentiometer enables the user to easily scale the output to display almost any current value required up to 1999A.

The DX-35-ACA meter can withstand momentary over loads of up to 200 Amps (40 times input signal) for one second without developing an open circuit. Our unique differential AC measurement circuit provides high impedance to ground on both sides of the shunt.

## Typical Application Connections

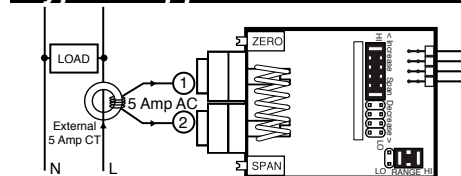

**AC Current measurement in Single-phase Systems.**  
Easily User Scaled to Display Currents up to 1999 Amps.

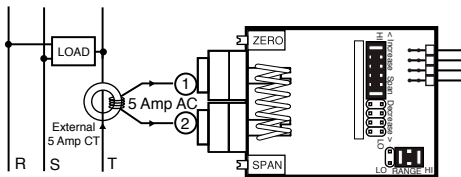

**AC Current measurement in Multi-phase Systems.**  
Easily User Scaled to Display Currents up to 1999 Amps in 3 Phase 3 Wire and 3 Phase 4 Wire Systems.

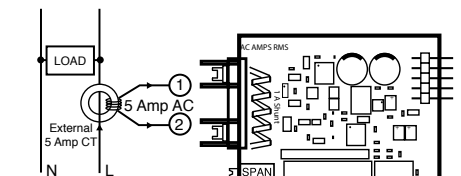

**AC True RMS Current measurement in Single-phase Systems.**  
Easily User Scaled to Display Currents up to 1999 Amps.

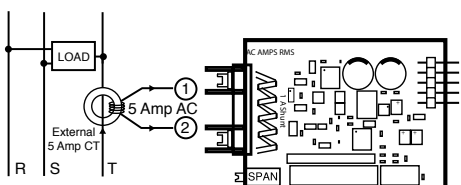

**AC True RMS Current measurement in Multi-phase Systems.**  
Easily User Scaled to Display Currents up to 1999 Amps in 3 Phase 3 Wire and 3 Phase 4 Wire Systems.

## Compatibility

The DX-Series have a matching DIN case style that is complementary to the Leopard and Tiger family of meters. DX-Meters are the OEM's choice for switchboard and process indication. Each model is dedicated to a specific application and designed for quick and easy installation.



## Specifications

- A/D Converter: .....12 bit dual slope
- Accuracy: .....±(0.05% of reading + 2 counts)
- Temp. Coeff.: .....100 ppm/°C (Typical)
- Warm up time: .....2 minutes
- Conversion Rate: .....3 conversions per second (Typical)
- Display: .....3 1/2 digit 0.56" Red LED display (std), 0.56" GREEN, 0.8" RED/GREEN or 0.56" Super Bright RED are optional. Range 0 to 1999 counts.
- Decimal Selection: .....Header under face plate, X•X•X•X
- Positive Overrange: ..1 (MSD) is displayed with all other digits blank.
- Power Supply: .....AC/DC Auto sensing wide range supply  
PS1 (std) .....85-265 VAC, 50-400Hz / 95-300 VDC @1.5W  
PS2 .....15-48 VAC,50-400Hz / 10-72 VDC @4.0W
- Operating Temp.: .....0 to 50 °C
- Storage Temp.: .....-20 °C to 70 °C.
- Relative Humidity: ....95% (non condensing)
- Case Dimensions: ....1/8 DIN, Bezel: 96x48 mm (3.78"x1.89")  
Depth behind bezel: 117 mm (4.61")  
Plus 11.8 mm (0.47") for Right-angled connector or plus 20 mm (0.79") for Straight-thru connector.
- Weight: .....8 oz., 11 oz when packed.
- Certification: .....UL Listed.

## DX-Series, the OEMs choice for switchboard and process indication

- DX-35-DCV ..... DC volts ±2V/±20V/±200V Header Selectable Ranges, 3.5 digit
- DX-35-DCA ..... DC mV ±50mV, ±100mV, ±200mV Header Selectable Ranges, 3.5 digit
- DX-35-ACV ..... AC volts, Scaled RMS (True RMS Opt.). 199.9/300V AC Header Selectable Ranges, 3.5 digit
- DX-35-ACA ..... AC amps, Scales RMS (True RMS Opt.). (5 Amp Internal Shunt), 3.5digit
- DX-35-CL ..... Process 4 to 20mA (100.0), easily user scalable, 3.5 digit w/Exc. opt
- DX-35-HZ ..... AC Line Frequency 15.0Hz to 199.9Hz. Up to 300V AC input, 3.5 digit

- DX-35-TC-KF ..... K Thermocouple with °F, optional °C, 3.5 digit
- DX-35-TC-JF ..... J Thermocouple with °F, optional °C, 3.5 digit
- DX-35-RTD-F ..... 100Ω platinum RTD, 3 or 4 wire, °F in 1° resolution, optional °C, 3.5 digit
- DX-40-ACV ..... AC volts, Scaled RMS (True RMS Opt.). 300.0V AC full scale, 4 digit
- DX-45-ACA ..... AC amps, Scaled RMS (True RMS Opt.). (5 Amp Internal shunt), 4.5 digit
- DX-45-DCV ..... DC volts ±2V/±20V/±200V Header Selectable Ranges, 4.5 digit
- DX-45-DCA ..... DC mV ±50mV/±100mV/±200mV Header Selectable Ranges, 4.5 digit
- DX-45-CL ..... Process 4 to 20mA (100.0), easily user scalable, 4.5 digit w/Exc opt.

## Connector Pinouts

This meter uses plug-in type screw terminal connectors for all connections.

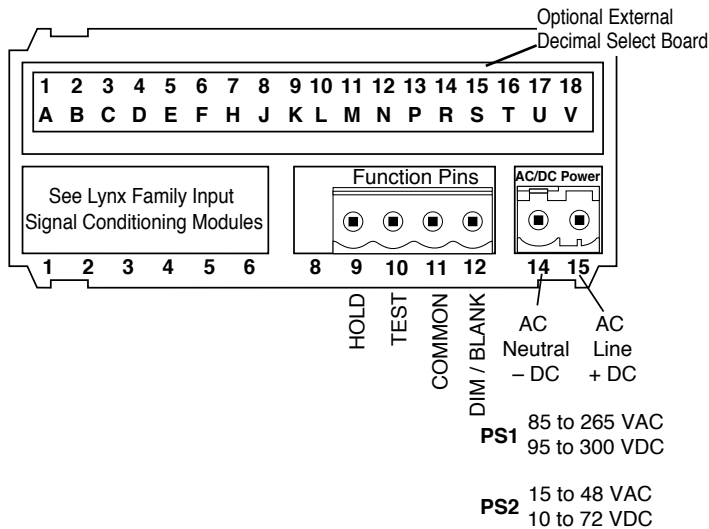

## Pin Descriptions

### Pins 1 & 2 - Input

**Pin 9 - Hold:** If this pin is left unconnected the meter will operate in a free running mode. When this pin is connected to the Common Pin 11, the meter display will be latched. A/D conversions will continue, but the display will not be updated until Pin 9 is disconnected from Pin 11.

**Pin 10 - Display Test:** When this pin is connected to the Common Pin 11, all segments of the display light up and 1888 is displayed. This is used to detect any missing segments in the display.

**Pin 11 - Common:** To Hold, Test or Dim the display, the respective pins have to be connected to this Common Pin.

**Pin 12 - Dim/Blank:** When this pin is connected to the Common Pin 11 the display is blanked out. If it is connected through an external 1KΩ pot, the display may be dimmed.

**Pin 14 & 15 - AC/DC Power Input:** These pins are the power pins of the meter and they only accept a special polarized screw terminal plug that can not be inserted into any other input socket. The standard meter has a auto sensing AC/DC power supply that operates from 85-265 VAC/95-300 VDC (PS1 Std). An optional isolated low voltage power supply that operates from 15-48 VAC/10-72 VDC (PS2) is also available.

### OPTIONAL EXTERNAL DECIMAL POINT SELECTION BOARD

**Pins 6, F - Decimal Common:** Connect to these pins to activate decimals.

**Pins 7, H - Decimal XXXX.:** Connect to pin 6 or pin F to activate decimal XXXX..

**Pins 8, J - Decimal XXX.X:** Connect to pin 6 or pin F to activate decimal XXX.X.

**Pins 9, K - Decimal XX.XX:** Connect to pin 6 or pin F to activate decimal XX.XX.

**Pins 10, L - Decimal X.XXX:** Connect to pin 6 or pin F to activate decimal X.XXX.

## Calibration Procedure

1. Apply an input of 0 amps AC to the meter by shorting the inputs.
2. Adjust the Zero Offset Pot until the meter reads 000.
3. Connect the secondary of the current transformer (CT) to the meter inputs, and apply a known current. For high current CTs, a known AC current, proportionate to the CT output, should be used for calibration.
4. Adjust the Span Pot until the meter displays the required reading for the current being applied.
5. The DX-35-ACA is now calibrated and ready for use.  
(Whenever a new range is selected, re-calibration is required to meet the specified accuracy).

## Component Layout

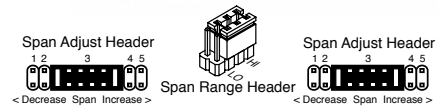
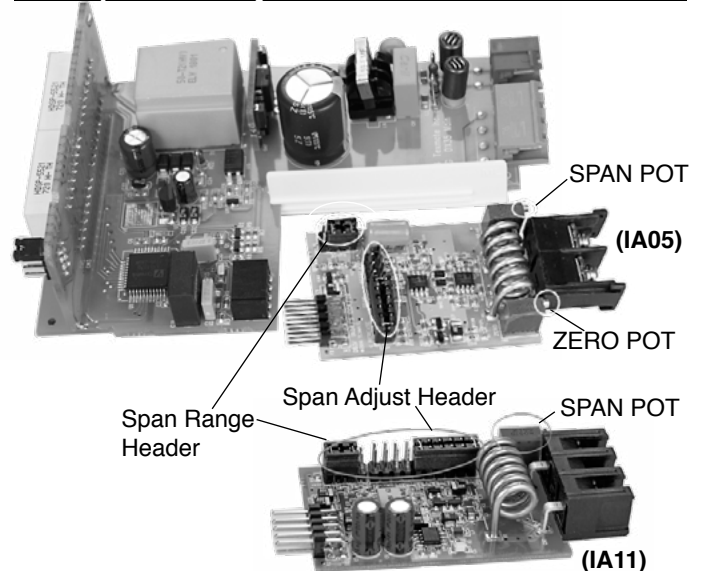

SPAN Adjust Header position	LO RANGE(0-1000)					HI RANGE(1000-1999)				
	1	2	3	4	5	1	2	3	4	5
SPAN Pot %	10%	10%	10%	10%	10%	10%	10%	10%	10%	10%
Signal Span %	10%	20%	30%	40%	50%	60%	70%	80%	90%	100%

## Signal Conditioning Components

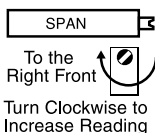

### SPAN Potentiometer (Pot)

The 15 turn SPAN pot is always on the right side (as viewed from the back of the meter). Typical adjustment is 100% of the input signal range.

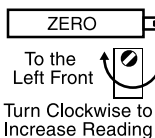

### ZERO Potentiometer (Pot)

The ZERO pot is always to the left of the SPAN pot (as viewed from the back of the meter). Typically it enables the display reading to be offset  $\pm 50$  counts.

## Opening Back Panel



To open back panel, insert a flat screwdriver or similar instrument in both slots on the top of the case and pry open. The DX-Series meters slide out from the rear of the case as a complete assembly.

## Decimal Point Selection

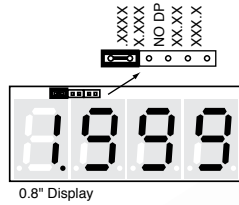
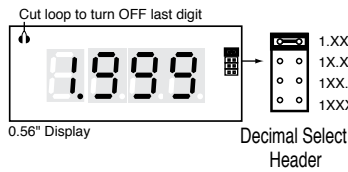

Decimal selection is made by moving the jumper to the indicated position on the header for the decimal required on the front of the display board.

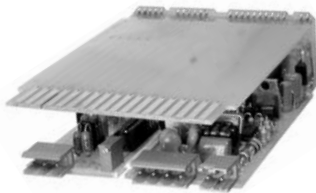

Optional External Decimal Point Selection Board

An optional output board is available that provides access to all decimal points via a rear PCB edge connector.

## Connectors

This meter uses plug-in type screw terminal connectors for all input and output connections. The power supply connections (pins 14 and 15) have a unique plug and socket outline to prevent cross connection. The main board uses standard right-angled connectors.

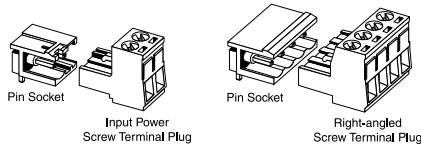

**WARNING:** AC and DC input signals and power supply voltages can be hazardous. Do Not connect live wires to screw terminal plugs, and do not insert, remove or handle screw terminal plugs with live wires connected.

## Installation Guidelines

1. Install and wire meter per local applicable codes/regulations, the particular application, and good installation practices.
2. Install meter in a location that does not exceed the maximum operating temperature and that provides good air circulation.
3. Separate input/output leads from power lines to protect the meter from external noise. Input/output leads should be routed as far away as possible from contactors, control relays, transformers and other noisy components. Shielding cables for input/output leads is recommended with shield connection to earth ground near the meter preferred.
4. A circuit breaker or disconnect switch is required to disconnect power to the meter. The breaker/switch should be in close proximity to the meter and marked as the disconnecting device for the meter or meter circuit. The circuit breaker or wall switch must be rated for the applied voltage (e.g., 120VAC or 240VAC) and current appropriate for the electrical application (e.g., 15A or 20A).
5. See *Case Dimensions* section for panel cutout information.
6. See *Connector Pinouts* section for wiring.
7. Use 28-12 AWG wiring, minimum 90°C (HH) temperature rating. Strip wire approximately 0.3 in. (7-8 mm).
8. Recommended torque on all terminal plug screws is 4.5 lb-in (0.51 N-m).



## Metal Surround Case Option

The meter's plastic case is made from fire retardant polycarbonate. A metal surround case can be ordered to enhance the meter's fire retardant capabilities and also provide shielding against electromagnetic interference (EMI). The metal case slides over the polycarbonate case and is held firmly in place by spring-type non-return clips. The Metal Surround Case must be factory installed on the polycarbonate case and once installed, it cannot be removed in the field.

With the metal case in place, the meter's standard ratchet-type mounting clips can not be used. Instead a pair of screw-type DIN standard mounting clips are provided, which clip into holes on the side of the metal case and tighten against the rear of the panel. A ground tab on the metal case enables the metal case to be easily connected to the panel ground.

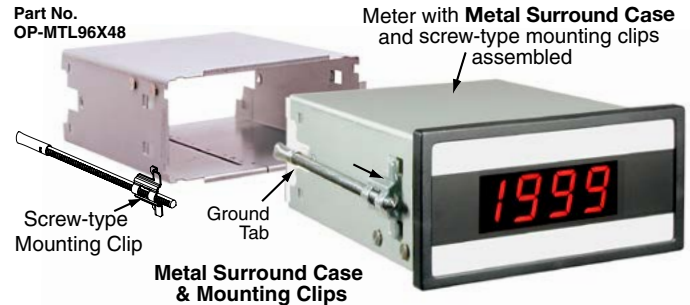

## Clear Lockable Water-proof Cover

The clear lockable cover is designed to be dust and water proof to NEMA-4X, IP65 standards. The assembly consists of a base and cover with a cam hinge and key-lock fastening mechanism. An O-ring, or neoprene gasket forms a seal between the base and the panel. The cam hinge prevents the cover from closing when opened until pushed closed. The cover has a tapered recess that, when closed, forms a seal with a tapered spigot on the base. A key-lock employs a cam locking device to force the spigot into the recess, ensuring seal integrity. A safety catch keeps the cover closed even when the key is removed, and the keyhole can be used to attach a safety seal clip, preventing unauthorized opening.

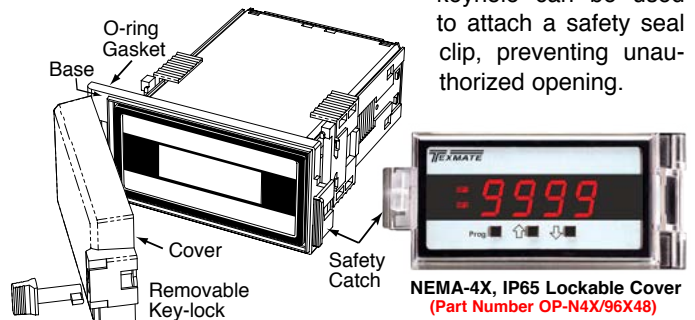

## Optional Face Plate Descriptors

To customize the face plate, clear adhesive label containing various popular descriptors may be ordered. Choose the descriptor desired, peel off the adhesive backing and align the descriptor in the center right of the faceplate.



P.N.: DU-CASEDES

# DX Case Dimensions and Panel Cutouts

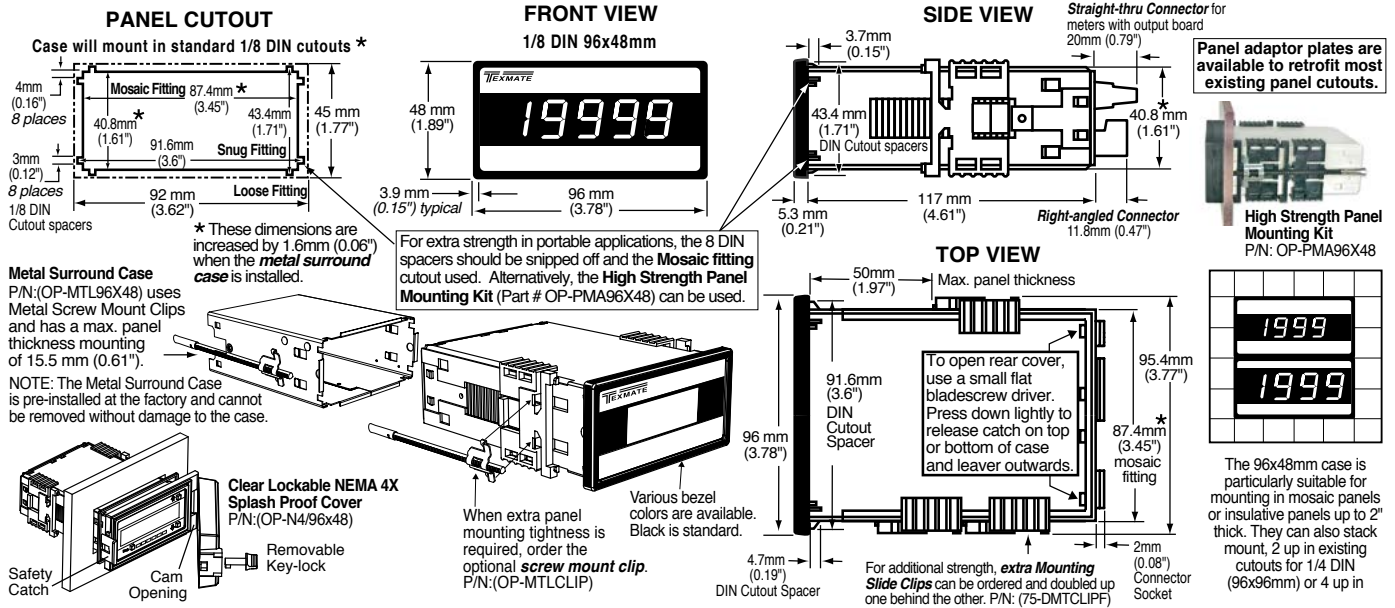

## Ordering Information

### Standard Options for this Model Number

Part Number	Description	List
-------------	-------------	------

► **BASIC MODEL NUMBER** Includes plug in type screw terminals, standard display and standard power supply unless optional versions are ordered.  
**DX-35-ACA**..... AC amps, Scaled RMS. (5 Amp Internal shunt) IA05 .  
**RMS OPTION** ..... AC amps, True RMS. (5 Amp Internal shunt) IA11 . . .

#### ► DISPLAY

DR . . . Red LED, 0.56 inch high . . . . .		
DB . . . Super-bright Red LED, 0.56 inch high . . . . .		
DG . . . Green LED, 0.56 inch high . . . . .		
LG . . . Large Green LED, 0.8 inch high . . . . .		
LR . . . Large Red LED, 0.8 inch high . . . . .		

#### ► POWER SUPPLY

PS1 . . . 85-265VAC/95-300VDC . . . . .		
PS2 . . . 15-48VAC/10-72VDC . . . . .		

### Special Options and Accessories

Part Number	Description	List
-------------	-------------	------

#### ► SPECIAL OPTIONS (Specify Inputs or Outputs & Req. Reading)

CR-CHANGE . . . Calibrated Range Change to another Standard Range. . .  
 CS-3/3.5/4. . . . Custom display scaling within std. ranges . . . . .  
 OP-DXEXTDP. . . External Dec. Pt. W/Conn. Option-Factory Installed . .

#### ► ACCESSORIES (Specify Serial # for Custom Artwork Installation)

75-DBBZ9648F. . . Extra Black Bezel for 96x48mm Case . . . . .  
 75-DMTCLIPF. . . Side Slide Brackets (2 pc) - extra set, extra strength . . .  
 76-D35G-N4 . . . NEMA 4 Green LED Faceplate, Factory Installed . . .  
 76-D35LG-N4 . . . NEMA 4 Large Green LED Faceplate, Factory Installed . . .  
 76-D35LR-N4 . . . NEMA 4 Large Red LED Faceplate, Factory Installed . . .  
 76-D35R-N4 . . . NEMA 4 Red LED Faceplate, Factory Installed. . .  
 CN-L18 . . . . . Dual Row 18 Pin Edge Connector, Solder Type . . . . .  
 DN-CAS96X48B . . . Complete 96 X 48 mm Case with bezel . . . . .  
 OP-MTLCILP. . . . Screw Mount Clips (2 pc) - to screw tighten slide brackets . . .  
 OP-MTL96X48 . . . Metal Surround Case, includes screw mounting clips . . .  
 OP-N4X/96X48 . . . 96x48mm clear lockable front cover-NEMA 4X, splash proof . . .  
 DU-CASEDES. . . Clear adhesive descriptors label for face plate . . .

### WARRANTY

Texmate warrants that its products are free from defects in material and workmanship under normal use and service for a period of one year from date of shipment. Texmate's obligations under this warranty are limited to replacement or repair, at its option, at its factory, of any of the products which shall, within the applicable period after shipment, be returned to Texmate's facility, transportation charges pre-paid, and which are, after examination, disclosed to the satisfaction of Texmate to be thus defective. The warranty shall not apply to any equipment which shall have been repaired or altered, except by Texmate, or which shall have been subjected to misuse, negligence, or accident. In no case shall Texmate's liability exceed the original purchase price. The aforementioned provisions do not extend the original warranty period of any product which has been either repaired or replaced by Texmate.

### USER'S RESPONSIBILITY

We are pleased to offer suggestions on the use of our various products either by way of printed matter or through direct contact with our sales/application engineering staff. However, since we have no control over the use of our products once they are shipped, NO WARRANTY WHETHER OF MERCHANTABILITY, FITNESS FOR PURPOSE, OR OTHERWISE is made beyond the repair, replacement, or refund of purchase price at the sole discretion of Texmate. Users shall determine the suitability of the proDXct for the intended application before using, and the users assume all risk and liability whatsoever in connection therewith, regardless of any of our suggestions or statements as to application or construction. In no event shall Texmate's liability, in law or otherwise, be in excess of the purchase price of the product.

Texmate cannot assume responsibility for any circuitry described. No circuit patent or software licenses are implied. Texmate reserves the right to change circuitry, operating software, specifications, and prices without notice at any time.



450 State Place • Escondido, CA 92029

Tel: 1-760-598-9899 • USA 1-800-839-6283 • 1-800-TEXMATE

Fax: 1-760-598-9828 • Email: orders@texmate.com • Web: www.texmate.com

DX-35-ACA Technical Manual Copyright © 2018 Texmate Inc. All rights reserved. Published by: Texmate Inc. USA. Information in this Technical Manual is subject to change without notice due to correction or enhancement. The information described in this manual is proprietary to Texmate, Inc. and may not be copied, reproduced or transmitted, in whole or in part, in connection with the design, manufacture, or sale of apparatus, device or private label product without the express written consent of Texmate, Inc.