

ZIP™ Tile for the BBC micro:bit

www.kitronik.co.uk/5645



The ZIP™ Tile is a display panel for the BBC micro:bit. It can scroll text, show all the colours of the rainbow and more, and multiple Tiles can be linked up to create even bigger displays!

It features 64 colour addressable LEDs arranged in an 8 x 8 grid, ZIP™ LED expansion points on the left, right and top of the board, and the ability to connect a BBC micro:bit with both bolts and croc clips. It also breaks out P1 & P2 to standard 0.1" footprints. Each of these pins also have the required supply voltage and GND pads.

Power is provided via a JST connector on the rear of the board. The board produces a **regulated supply** that is fed into the 3V and GND connections to **power the connected BBC micro:bit**, removing the need to power it separately. To protect the BBC micro:bit if power is supplied through it, the ZIP™ LEDs will not illuminate.

Connecting a BBC micro:bit: To use the ZIP™ Tile, the BBC micro:bit needs to be connected to at least the GND, 3V and Pin 0 connections on the ZIP™ Tile. The BBC micro:bit can be connected via board-mounted nuts and M3 bolts (make sure the provided spacer is placed between the BBC micro:bit and the ZIP™ Tile if connecting on the rear), or croc clips. See page 3 for detailed images.

Examples: For some starter code and ideas for what else you could do, go to <http://www.kitronik.co.uk/5645>

Caution:

ZIP™ LEDs may become hot if used at high brightness. Exercise caution when using the Tile for prolonged periods.



Front View:

M2 Mounting Hole

64 ZIP™ LEDs
(8 x 8 Display)
[Pin 0]

M2 Mounting Hole

M2 Mounting Hole

M2 Mounting Hole

BBC micro:bit
Bolt-on Connector

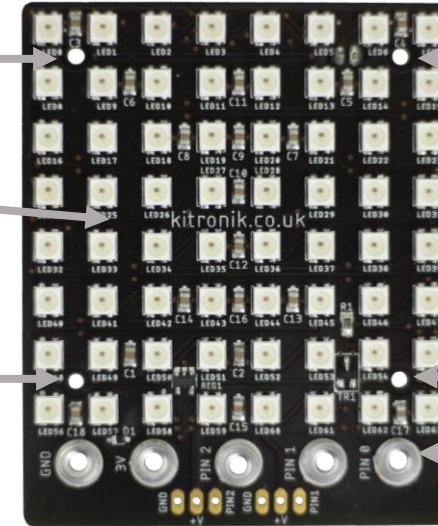

ZIP™ LED
Expansion Pads
(from left):

- 1 – GND
- 2 – DOUT
- 3 – +BATT V
- 4 – DIN
- 5 – GND

ZIP™ LED
Expansion Pads
(from top):

- 1 – GND
- 2 – DIN
- 3 – +BATT V
- 4 – GND

Pin Expansion Pads:
Left – Pin 2
Middle – +BATT V
Middle – GND

Rear View:

JST Power Connector
(3.5-5.3V)

ZIP™ LED
Expansion Pads
(from top):

- 1 – GND
- 2 – DOUT
- 3 – +BATT V
- 4 – GND

Pin Expansion Pads:
Left – Pin 1
Middle – +BATT V
Right – GND



Board Dimensions:

(All measurements are given in mm)

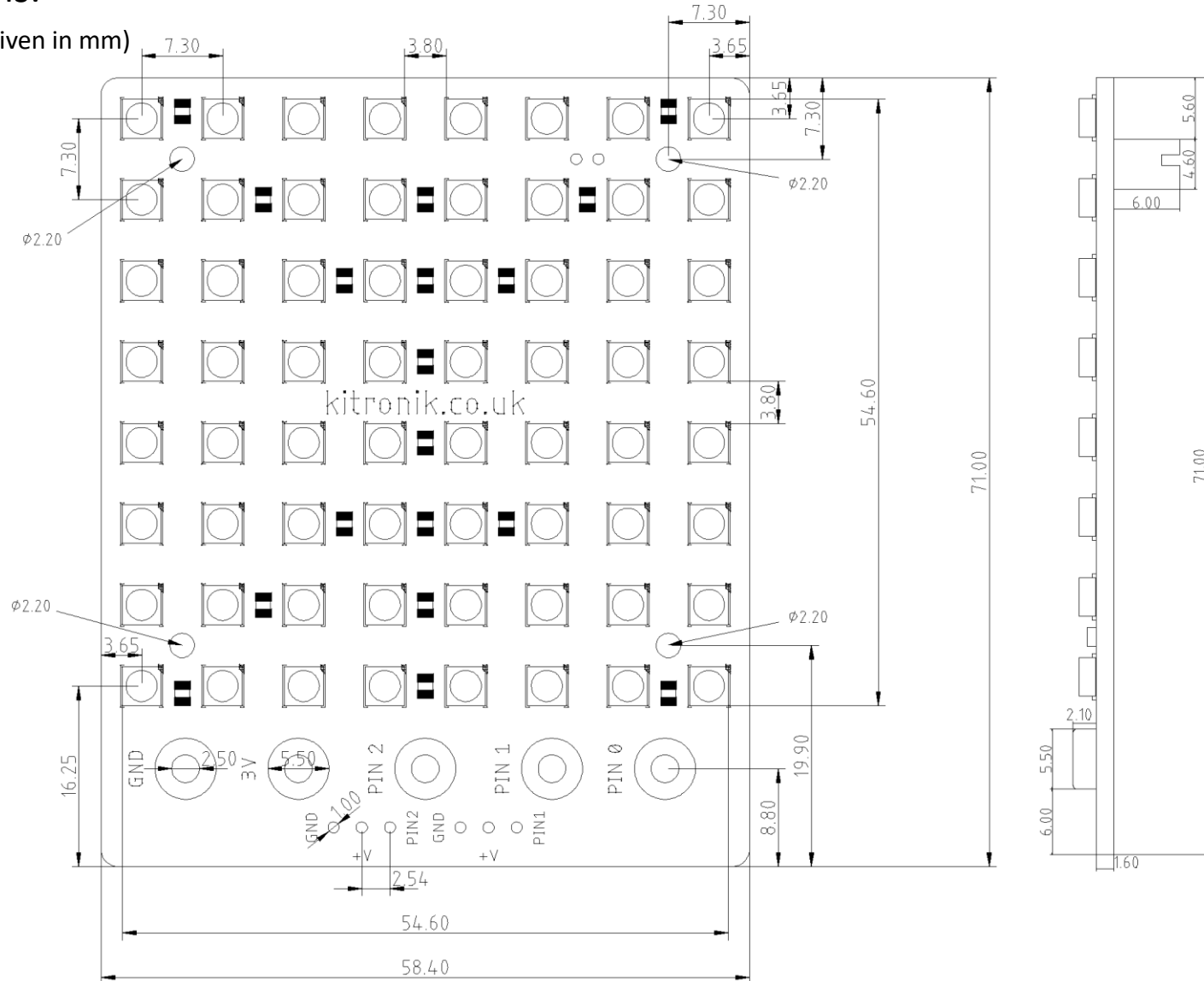

Electrical Information

Operating Voltage (Vcc) [ZIP LEDs]	+3.5V – +5.3V
Regulated Voltage [BBC micro:bit]	+3.3V
Max Current (ZIP LEDs White @ 100% brightness, +5.3V supply)	2.73A (41mA per ZIP LED, 250mA max on +3.3V reg. voltage)
Number of ZIP LEDs	64
Expansion Connections	3 x ZIP LED (1 x DIN, 1 x DOUT, 1 x DIN/DOUT) 2 x IO pins (each IO pin rated +3.3V @ 5mA) 2 x +V (Operating Voltage, see above)

BBC micro:bit 'Hidden':



M3x12 Screws x 5



Plastic Spacers x 5

Attaching the BBC micro:bit:

The Tile is supplied with 5 M3x12 countersunk screws and 5 plastic spacers. These are used to attach the BBC micro:bit to the ZIP™ Tile, with the spacers going in-between the Tile and BBC micro:bit.

The BBC micro:bit can be attached to the Tile in one of two positions:

- The images on the left show the BBC micro:bit in the 'Hidden' position.
- The image to the right shows the BBC micro:bit in the 'Visible' position. (Note that the Tile is upside down when connected in this way).

For software (see page 5) it is assumed that the BBC micro:bit is the correct way up.

BBC micro:bit 'Visible':

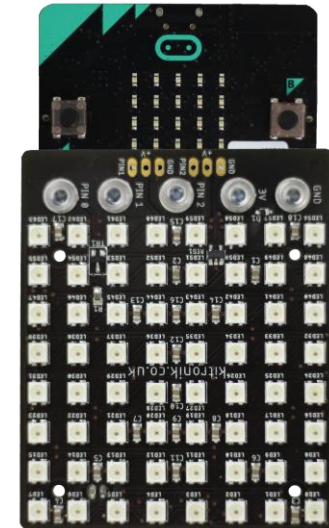

Connecting Multiple ZIP™ Tiles

The Tiles are designed to be able to be joined together in a variety of configurations to create larger displays. Simply match the DOUT and power connections from one Tile with the DIN and power connections of the next. It is recommended to use a piece of solid core wire to help provide support when soldering the connection points together, or mounting the Tiles on a supportive backing material.

The Tiles can be connected side by side, and top to top (**NOTE: Make sure to only connect ONE DOUT/DIN pair when connecting in this way**).

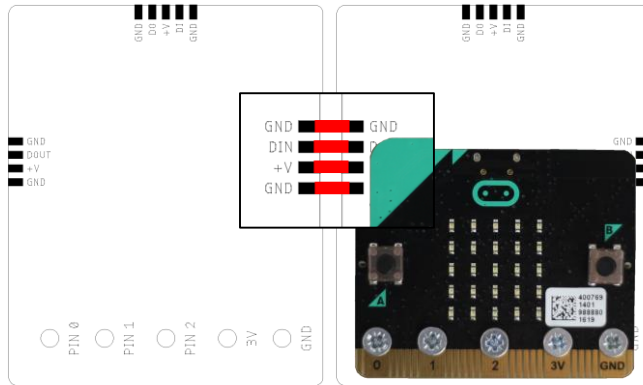

The Tiles to the left are connected side-by-side in a 2 x 1 configuration. For software purposes, the BBC micro:bit is in the 'Hidden' position.

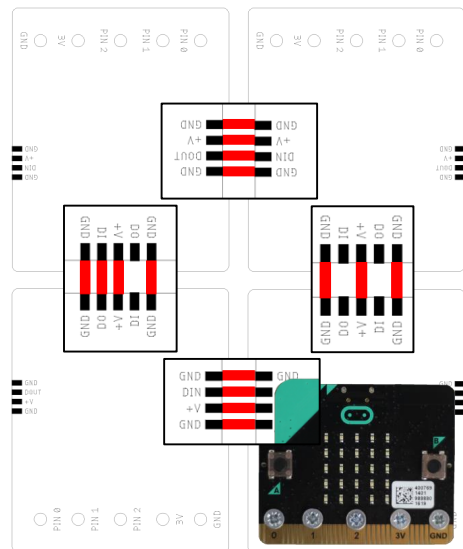

Note: All solder connections are shown in red and bridging the gap between the Tiles.

The Tiles to the left are connected side-by-side and top-to-top in a 2 x 2 configuration. For software purposes, the BBC micro:bit is in the 'Hidden' position.

The Tiles to the left are connected top-to-top in a 1 x 2 configuration. For software purposes, the BBC micro:bit is in the 'Hidden' position.

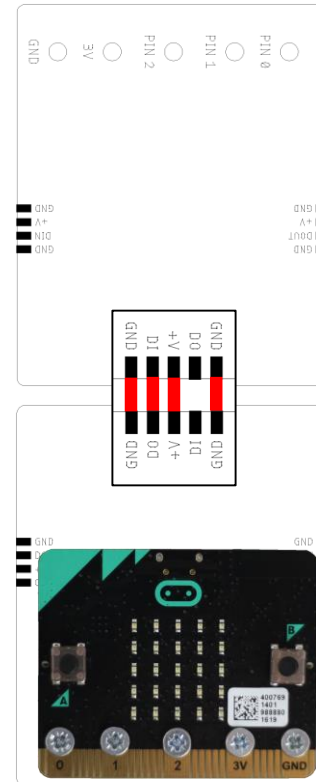

The Tiles to the left are connected top-to-top in a 1 x 2 configuration. For software purposes, the BBC micro:bit is in the 'Visible' position.

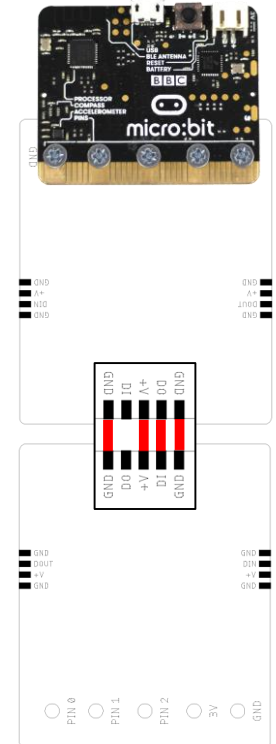

Microsoft MakeCode Blocks Editor Code

This program was created in the Microsoft MakeCode Blocks Editor for the BBC micro:bit. It sets up a single ZIP Tile display (with 8 columns and 8 rows) with the brightness set to 128. Initially, the ZIP Tile is set to display all green. Pressing button A will scroll the message 'Hello world' left across the Tile with a delay of 25ms, with white text on a green background. Pressing button B clears the Tile and sets the ZIP LED at coordinates (4, 5) to be purple, and then makes the changes visible. **Note: There is a Kitronik package available for the ZIP™ Tile on Microsoft MakeCode (the green blocks shown here).**

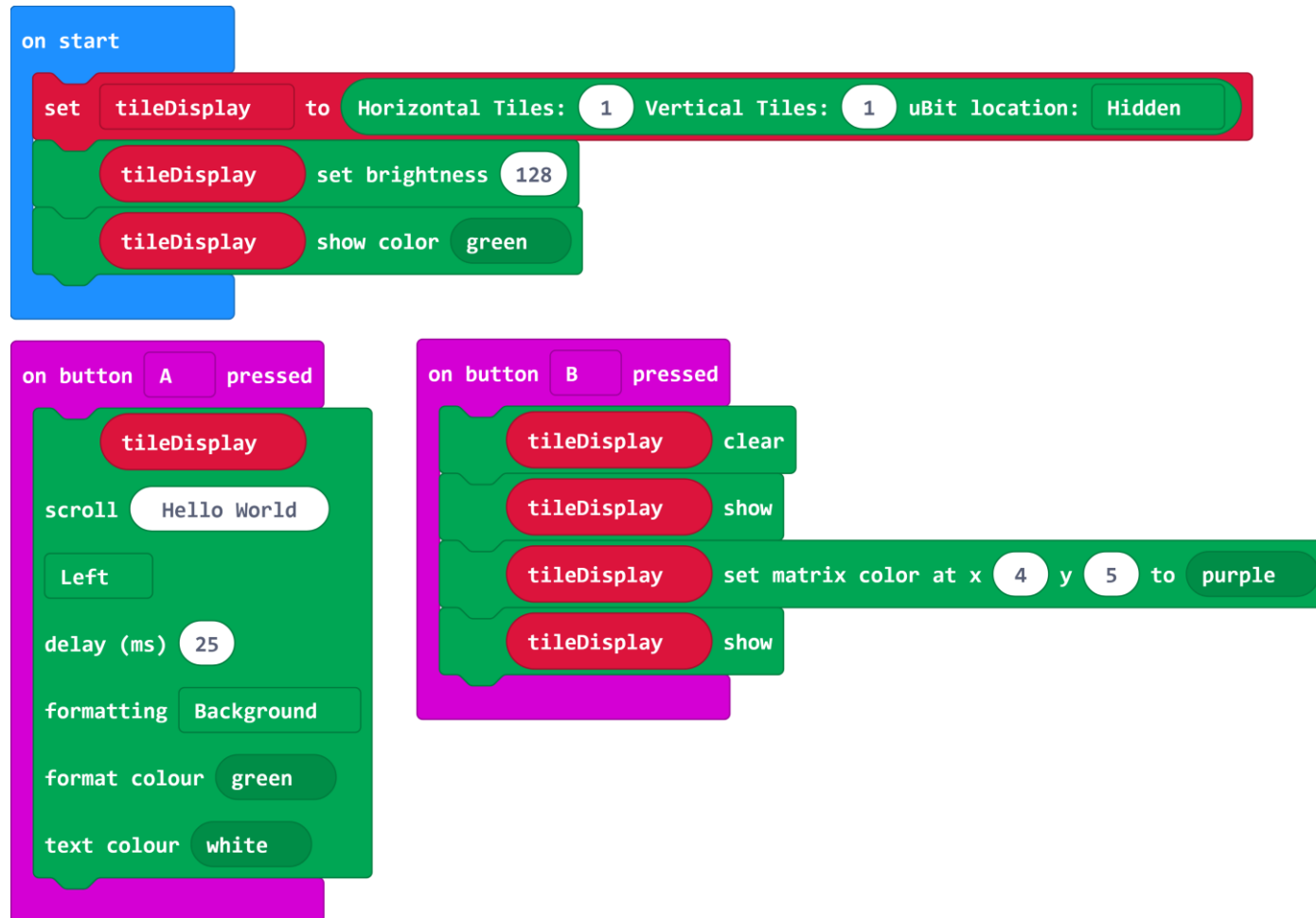

```
on start
  set tileDisplay to Horizontal Tiles: 1 Vertical Tiles: 1 uBit location: Hidden
  tileDisplay set brightness 128
  tileDisplay show color green

on button A pressed
  tileDisplay
  scroll Hello World
  Left
  delay (ms) 25
  formatting Background
  format colour green
  text colour white

on button B pressed
  tileDisplay clear
  tileDisplay show
  tileDisplay set matrix color at x 4 y 5 to purple
  tileDisplay show
```