

MATERIALS AND FINISHES

BODY, COUPLING NUT: STAINLESS STEEL  
PLATED GOLD OVER NICKEL

CENTER CONTACT: BRASS  
PLATED GOLD OVER NICKEL

INSULATOR: TEFLON

GASKET: SILCONE RUBBER

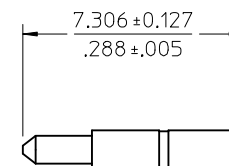
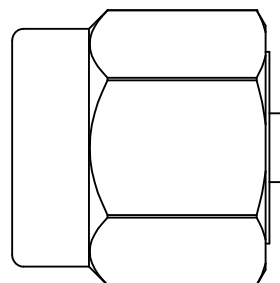
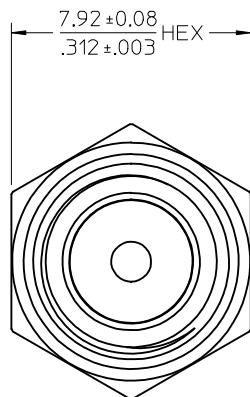
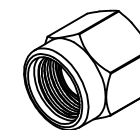

CONTACT

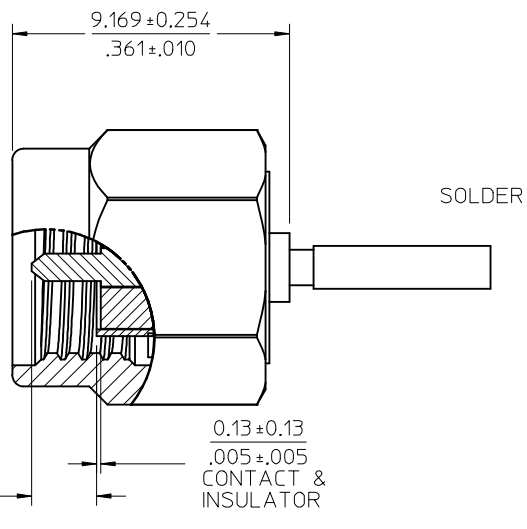

SOLDER

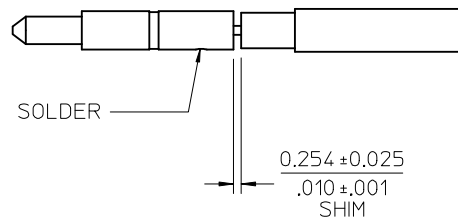

SOLDER

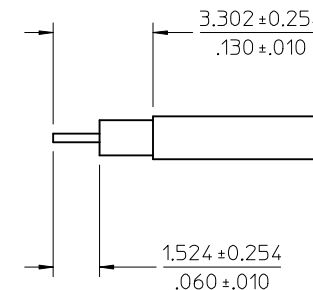

PART # 73251-3830

MIL-STD-348A, FIG. 310.1		INTERFACE																
SPECIFICATION		DESCRIPTION																
GENERAL TOLERANCES (UNLESS SPECIFIED)		DIMENSION STYLE MM/IN	SCALE METRIC															
<table border="1"> <tr> <th></th> <th>mm</th> <th>INCH</th> </tr> <tr> <td>4 PLACES</td> <td>± .005</td> <td>± .0005</td> </tr> <tr> <td>3 PLACES</td> <td>± .003</td> <td>± .0003</td> </tr> <tr> <td>2 PLACES</td> <td>± .002</td> <td>± .0002</td> </tr> <tr> <td>1 PLACE</td> <td>± .001</td> <td>± .0001</td> </tr> </table>			mm	INCH	4 PLACES	± .005	± .0005	3 PLACES	± .003	± .0003	2 PLACES	± .002	± .0002	1 PLACE	± .001	± .0001	DRAWN BY AZR	DATE 2009/06/17
	mm	INCH																
4 PLACES	± .005	± .0005																
3 PLACES	± .003	± .0003																
2 PLACES	± .002	± .0002																
1 PLACE	± .001	± .0001																
ANGULAR ± 2° DRAFT WHERE APPLICABLE MUST REMAIN WITHIN DIMENSIONS		CHECKED BY SSS	DATE 2009/06/17															
		APPROVED BY JDW	DATE 2009/06/17															
		MATERIAL NO. 732513830	DOCUMENT NO. SD-73251-383															
		TITLE SMA PLUG STRAIGHT FOR 047 CABLE 50 OHMS SMA-PC																
		MOLEX INCORPORATED SHEET NO. 1 OF 1																
THIS DRAWING CONTAINS INFORMATION THAT IS PROPRIETARY TO MOLEX INCORPORATED AND SHOULD NOT BE USED WITHOUT WRITTEN PERMISSION																		

CHG: RELEASE  
DRAWING.  
EC NO: URF2009-0751  
DRWIN:ROBERTSON 2009/06/18  
CHKD:SSS 2009/06/18  
APPR:WIENER 2009/06/18

QUALITY SYMBOLS

MATERIALS AND FINISHES

BODY, COUPLING NUT: STAINLESS STEEL  
PLATED GOLD OVER NICKEL

CENTER CONTACT: BRASS  
PLATED GOLD OVER NICKEL

INSULATOR: TEFLON

GASKET: SILCONE RUBBER

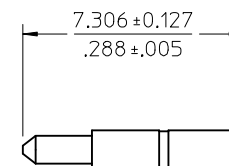
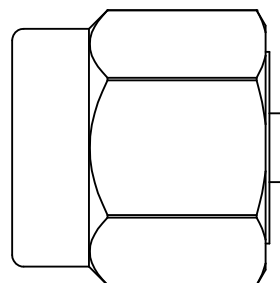
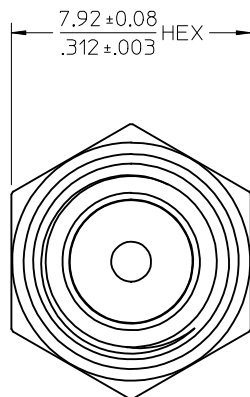
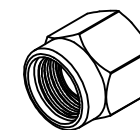

CONTACT

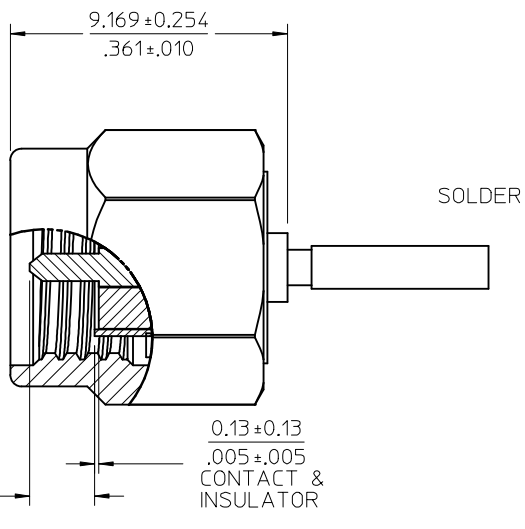

SOLDER

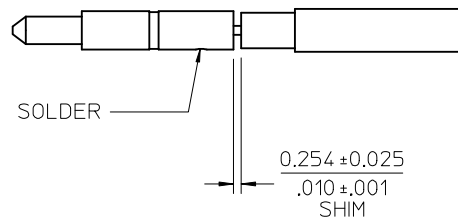

SOLDER

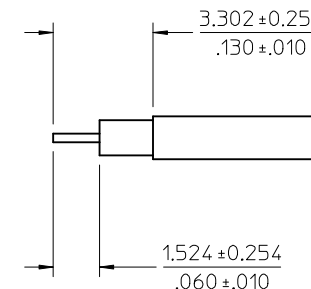

PART # 73251-3830

MIL-STD-348A, FIG. 310.1		INTERFACE	
SPECIFICATION		DESCRIPTION	
DIMENSION STYLE MM/IN		SCALE	DESIGN UNITS METRIC
DRAWN BY AZR		DATE 2009/06/17	TITLE SMA PLUG STRAIGHT FOR 047 CABLE 50 OHMS SMA-PC
CHECKED BY SSS		DATE 2009/06/17	MOLEX INCORPORATED
APPROVED BY JDW		DATE 2009/06/17	
MATERIAL NO. 732513830		DOCUMENT NO. SD-73251-383	SHEET NO. 1 OF 1
THIS DRAWING CONTAINS INFORMATION THAT IS PROPRIETARY TO MOLEX INCORPORATED AND SHOULD NOT BE USED WITHOUT WRITTEN PERMISSION			

CHG: RELEASE  
DRAWING.  
EC NO: URF2009-0751  
DRWIN:ROBERTSON 2009/06/18  
CHKD:SSS 2009/06/18  
APPR:WIENER 2009/06/18

QUALITY SYMBOLS  
 = 0  
 = 0

GENERAL TOLERANCES (UNLESS SPECIFIED)

	mm	INCH
4 PLACES	± .005	± .0004
3 PLACES	± .003	± .0002
2 PLACES	± .002	± .0001
1 PLACE	± .001	± .00005

ANGULAR ± 2 °

DRAFT WHERE APPLICABLE  
MUST REMAIN  
WITHIN DIMENSIONS