

2.4mm coaxial connectors for frequency test measurements

2.4mm Series



Compatible with 50GHz configurations

■ Features

1. Complies with MIL-STD-348B Standard
2. Supports up to 50GHz frequency
3. Screw mounting

- Provides excellent high frequency performance and consistent mounting quality
- Reusable
- Reduces mounting complexity (No Soldering is required)

4. Flexible PCB thickness

5. 0.085 inch flexible cable applicable

6. RoHS2 compliant

■ Applications

Data transmission measurement, Radio communication equipment, Measuring instruments, RF module, Radio power amplifier, High speed router, High speed switch etc.

■ Functional diagram

Plug side

■ Straight plug

H2.4-P-SS085



Receptacle side

■ PCB vertical launch receptacle (For high-speed test board applications.)

H2.4-R-SR2-1



Attenuator

■ Plug—Jack

H2.4-AT (**)-PJ

** : 0, 1, 2, 3, 4, 5, 6, 7, 8, 9, 10, 20dB



■ PCB end launch receptacle (For high-speed test board applications.)

H2.4-LR-SR2



Product Specifications

Ratings	Nominal characteristic impedance	50Ω	Operating Temperature Range	-55°C to +105°C (95% RH or less)
	Rated frequency	0 to 50GHz	Storage Temperature Range	-55°C to +50°C (95% RH or less)
Items	Specifications		Conditions	
1. Contact resistance	Center : Not greater than 4mΩ External : Not greater than 2mΩ		Measured at 100mA or below	
2. Insulation resistance	Not less than 1,500MΩ (H2.4-P-SS085) Not less than 5,000MΩ (H2.4-R-SR2-1)		Measured at 500V DC	
3. Withstanding voltage	No flashover or breakdown		500V AC for one minute	
4. Voltage standing wave ratio	● H2.4-P-SS085		● H2.4-R-SR2-1	● H2.4-LR-SR2
	V.S.W.R. : Not greater than 1.35 (0 to 40GHz)		V.S.W.R. : Not greater than 1.35 (0 to 26.5GHz)	V.S.W.R. : Not greater than 1.3 (0 to 40GHz)
	V.S.W.R. : Not greater than 1.45 (40GHz to 50GHz)		V.S.W.R. : Not greater than 1.4 (26.5GHz to 40GHz)	V.S.W.R. : Not greater than 1.4 (40GHz to 50GHz)
5. Mating Cycles	Contact resistance at center : Not greater than 6mΩ External : Less than 4mΩ No broken, cracked, or loose parts		500 cycles	
6. Vibration resistance	No electrical discontinuity for not less than 1μs. No broken, cracked, or loose parts		Frequency : 10 to 2000Hz, half amplitude : 0.75mm, Acceleration : 196m/s ² , 10 cycles in each of the 3 axis	
7. Shock resistance	No electrical discontinuity for not less than 1μs. No broken, cracked, or loose parts		Acceleration : 980m/s ² , duration : 6ms, Wave form : half-sine wave, 3 times in each of the 3 axis	
8. Moisture resistance of temperature/humidity cycle	Insulation resistance : Not less than 100MΩ (in high humidity environment) Insulation resistance : Not less than 500MΩ (in dry environment) No broken, cracked or loose parts		Left for 10 cycles (240 hours) in an environment with the temperature ranging from -10 to 65°C and the humidity ranging from 90 to 98%.	
9. Temperature cycle	No broken, cracked or loose parts		5 cycles of the following test series condition : Temperature : -55°C → — → +105°C → — Time : 30 min. → 3 min. → 30 min. → 3 min.	
10. Salt spray	No considerable corrosion		Continuous 48 hour cycle in 5% salt water solution	

*Measurement of voltage standing wave ratio (V.S.W.R.)

The specified values of the voltage standing wave ratio (V.S.W.R.) noted above, are taken with the test set up shown in the figure below :

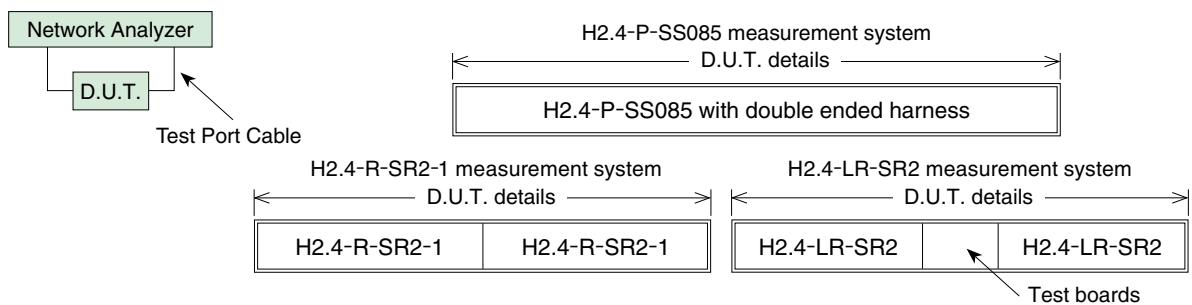

Materials / Finish

Part	Materials	Finish
Shell	Stainless steel / Brass	Passivated / Nickel plating
Insulator	PTFE resin / PEI resin	—
Contact	Beryllium copper	Gold plating
Ring	Stainless steel	Gold plating

Product Number Structure

Refer to the chart below when determining the product specifications from the product number. Please select from the product numbers listed in this catalog when placing orders.

H2.4 - [1] - [2]

① Series name : H2.4	③ Applicable cable or board mounting style SS085 : 0.085-inch, Flexible cable SR : PCB screw-mounting
② Connector type P : Straight plug R : Receptacle	

■ Plug

H2.4-P-SS085

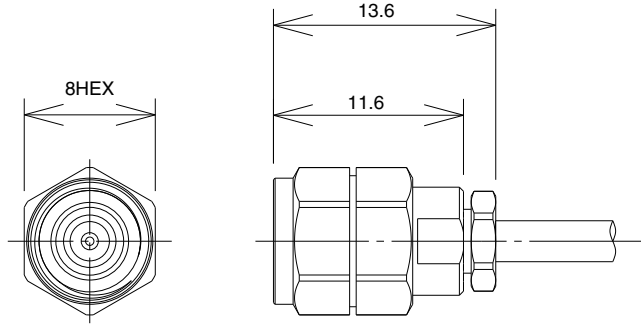

[Please contact Hirose in case of cable assemblies.]

■ PCB vertical mount receptacle

This receptacle is for high speed test board applications. Not applicable to actual commercial equipments.

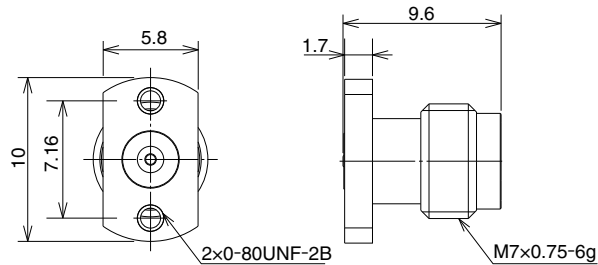

Part No.	HRS No.	Attached screw
H2.4-R-SR2-1	338-0607-0	—
H2.4-R-SR2-1(11)	338-0607-0 11	0-80UNF 1/4 inch
H2.4-R-SR2-1(12)	338-0607-0 12	0-80UNF 3/16 inch

◆ Frequency characteristics (TYPICAL)

*Signal line length between both connector ends : 25mm

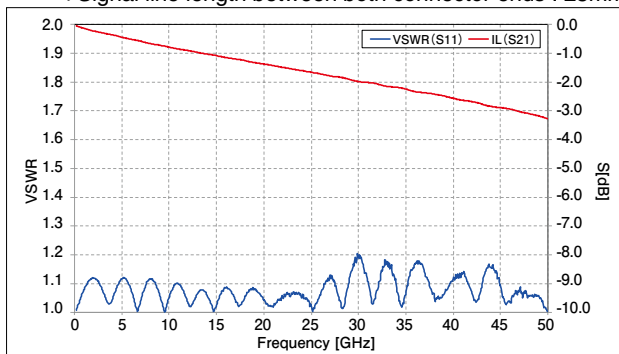

■ PCB end launch receptacle

Central contact solderless receptacles for high-speed test board applications. Not applicable to actual commercial equipments.

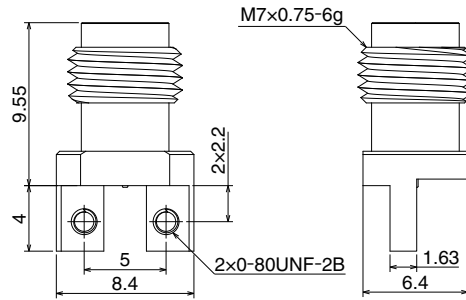

Part No.	HRS No.	Attached screw
H2.4-LR-SR2	338-0603-0	—
H2.4-LR-SR2(11)	338-0603-0 11	0-80UNF 1/4 inch
H2.4-LR-SR2(12)	338-0603-0 12	0-80UNF 3/16 inch

◆ Frequency characteristics (TYPICAL)

*Coplanar line length between both connector ends : 20mm

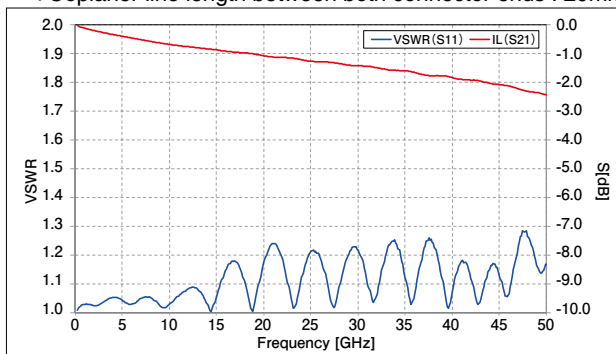

■ Attenuator ■ Product Specifications

Ratings	Nominal characteristic impedance	50Ω	Operating Temperature Range	-10°C to +65°C
	Rated frequency	DC to 50GHz		
	Power	1W CW (+65°C)	Operating relative humidity	90% RH or less

■ Materials / Finish

Part	Materials	Finish
Shell	Stainless steel	Passivate
Insulator	PTFE resin	—
Male contact	Brass	Gold plated
Female contact	Beryllium copper	Gold plated
Coupling	Stainless steel	Passivate
Resistive element	Metal film	—



■ Product Number Structure

H2.4 - AT (※※) - PJ

① ② ③ ④

① Series name	H2.4
② AT	Attenuator
③ Attenuation	(例) (0) : 0dB (through) (3) : 3dB (10) : 10dB
④ Connector type	PJ : Plug Jack

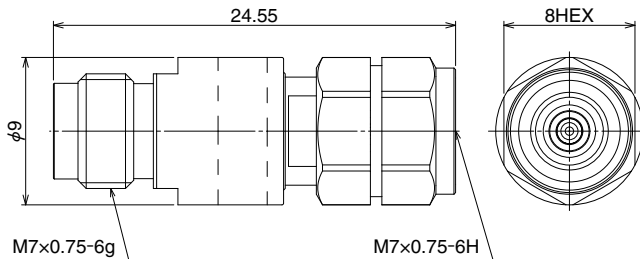

Part No.	HRS No.	Attenuation (dB)			Voltage standing wave ratio (V.S.W.R.)(max)	
		0~18GHz	18~26.5GHz	26.5~50GHz	0~12GHz	12~50GHz
H2.4-AT(0)-PJ	354-0290-0	0 ^{+0.5} ₀	0 ^{+0.8} ₀	0 ^{+1.0} ₀	1.35	1.4
H2.4-AT(1)-PJ	354-0309-0	1 ^{+0.8} _{-0.3}	1 ^{+1.0} _{-0.3}	1 ^{+1.6} _{-0.3}		
H2.4-AT(2)-PJ	354-0310-0	2 ^{+0.8} _{-0.3}	2 ^{+1.0} _{-0.3}	2 ^{+1.6} _{-0.3}		
H2.4-AT(3)-PJ	354-0291-0	3 ^{+0.7} _{-0.3}	3 ^{+0.8} _{-0.3}	3 ^{+1.5} _{-0.3}	1.3	1.4
H2.4-AT(4)-PJ	354-0311-0	4 ^{+0.7} _{-0.4}	4 ^{+0.9} _{-0.4}	4 ^{+1.6} _{-0.4}		
H2.4-AT(5)-PJ	354-0312-0	5 ^{+0.8} _{-0.4}	5 ^{+1.0} _{-0.4}	5 ^{+1.8} _{-0.4}		
H2.4-AT(6)-PJ	354-0292-0	6 ^{+0.8} _{-0.2}	6 ^{+0.9} _{-0.2}	6 ^{+1.5} _{-0.2}	1.35	1.45
H2.4-AT(7)-PJ	354-0313-0	7 ^{+1.0} _{-0.4}	7 ^{+1.2} _{-0.4}	7 ^{+2.0} _{-0.4}		
H2.4-AT(8)-PJ	354-0314-0	8 ^{+1.0} _{-0.5}	8 ^{+1.2} _{-0.5}	8 ^{+1.8} _{-0.5}		
H2.4-AT(9)-PJ	354-0315-0	9 ^{+1.0} _{-0.5}	9 ^{+1.2} _{-0.5}	9 ^{+1.8} _{-0.5}	1.35	1.4
H2.4-AT(10)-PJ	354-0293-0	10 ^{+0.9} _{-0.5}	10 ^{+1.0} _{-0.5}	10 ^{+1.6} _{-0.5}		
H2.4-AT(20)-PJ	354-0294-0	20±1.0	20 ^{+1.2} _{-1.0}	20 ^{+1.4} _{-1.0}		

◆ Frequency characteristics (TYPICAL)

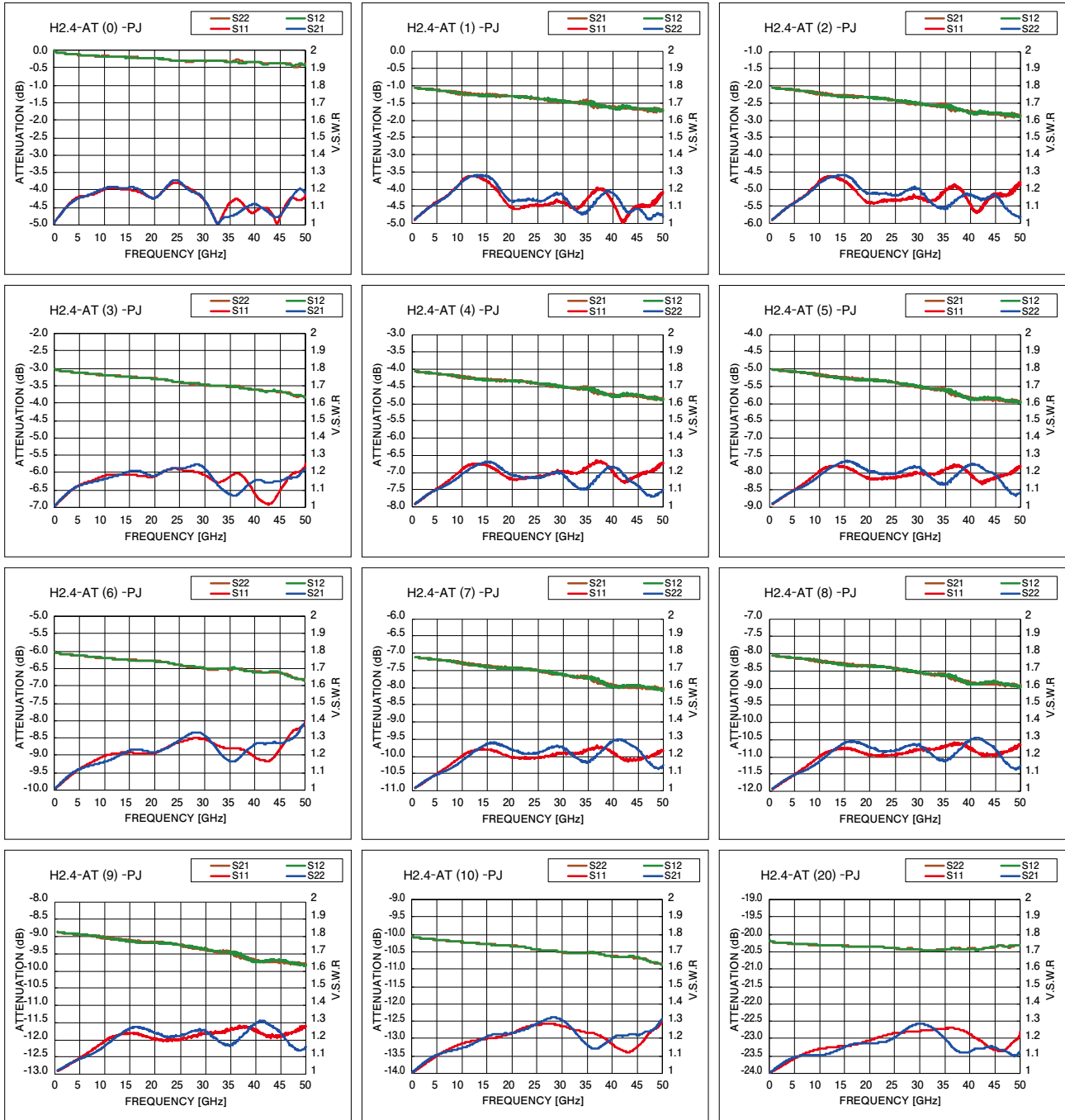

◆ Precautions

1. The diameter of the center contact pin is only 0.511mm.
Please handle with care. When mating the attenuator with the corresponding connector, rotate the hex part only.
2. When mating the attenuator, if any dust is found on the shell interface, please wipe with alcohol.



HIROSE ELECTRIC CO.,LTD.

2-6-3,Nakagawa Chuoh,Tsuzuki-Ku,Yokohama-Shi 224-8540,JAPAN

TEL: +81-45-620-3526 Fax: +81-45-591-3726

<http://www.hirose.com>

<http://www.hirose-connectors.com>