

**Contact Dimensions:**

**523-P.C. Tail .025 Sq.(0.64 Sq.) - Tail LG=.390(9.91)**

**.100 (2.54) Contact Spacing x .200 (5.08) Row Spacing**

THIS IS A C.A.D. GENERATED DRAWING  
DO NOT MAKE MANUAL REVISIONS TO MASTER.



ISSUE NUMBER

ORIGINAL

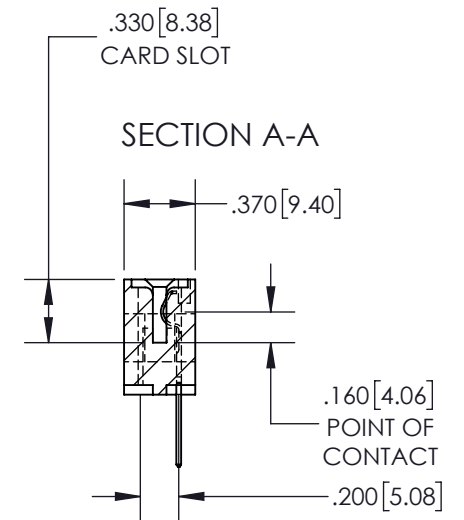
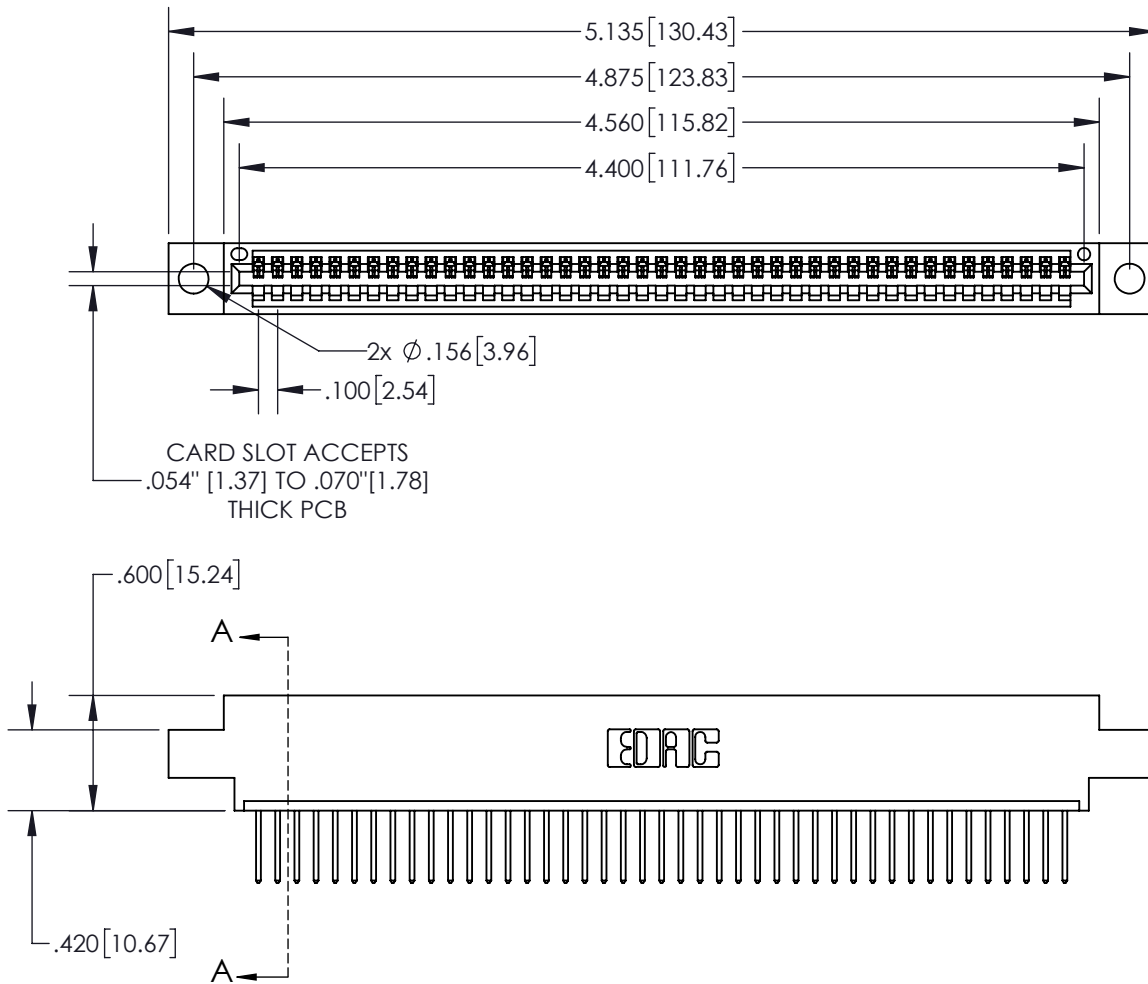

- INSULATOR MATERIAL: THERMOPLASTIC, UL 94V-0
- CONTACT MATERIAL; COPPER TIN ALLOY
- CONTACT PLATING: GOLD ON THE MATING AREA, TIN PLATING ON THE CONTACT TAILS, NICKEL UNDERPLATE

**845/895 SERIES HIGH TEMP CARD EDGE CONNECTOR  
PART NUMBER: 895-043-523-604**



YOUR CONNECTION TO QUALITY & SERVICE

EDAC INC  
TORONTO, ONTARIO  
CANADA

THESE DRAWINGS AND SPECIFICATIONS ARE THE PROPERTY OF EDAC INC. AND SHALL NOT BE REPRODUCED, OR COPIED OR USED AS THE BASIS FOR THE MANUFACTURE OR SALE OF APPARATUS WITHOUT WRITTEN PERMISSION.

ACAD REFERENCE NO. 845-ENG-MASTER

DRAWN: R.STA.MONICA DATE MAY.16/2017

CHECKED: DATE:

SCALE: 1:1 SHEET 1 OF 2

DRAWING NUMBER 845-ENG-MASTER ISSUE 1

THIS IS A C.A.D. GENERATED DRAWING  
DO NOT MAKE MANUAL REVISIONS TO MASTER.



ISSUE NUMBER

ORIGINAL

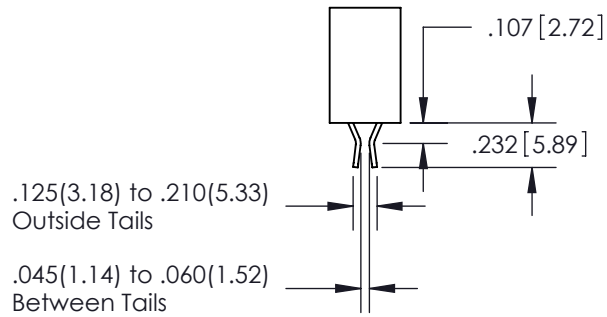

**Contact Code 555**

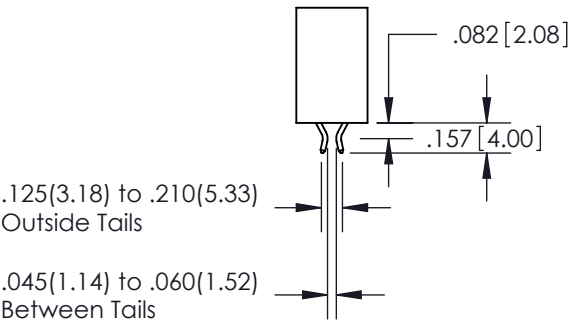

**Contact Code 556**



**Contact Code 558**



**Contact Code 559**



**Contact Code 560**

- INSULATOR MATERIAL: THERMOPLASTIC POLYESTER, UL 94V-0
- DAP MATERIAL AVAILABLE UPON REQUEST
- CONTACT MATERIAL: COPPER ALLOY
- CONTACT PLATING: GOLD ON THE MATING AREA, TIN PLATING ON THE CONTACT TAILS, NICKEL UNDERPLATE

**845/895 SERIES HIGH TEMP CARD EDGE CONNECTOR  
CONTACT CODE 555,556,558,559,560 DIMENSIONS**



THESE DRAWINGS AND SPECIFICATIONS ARE THE PROPERTY OF EDAC INC. AND SHALL NOT BE REPRODUCED, OR COPIED OR USED AS THE BASIS FOR THE MANUFACTURE OR SALE OF APPARATUS WITHOUT WRITTEN PERMISSION.

ACAD REFERENCE NO. 845-ENG-MASTER	
DRAWN: R.STA.MONICA	DATE: MAY.16/2017
CHECKED:	DATE:
SCALE: 1:1	SHEET 2 OF 2
DRAWING NUMBER 845-ENG-MASTER	ISSUE 1