

Contact Detail:
501-Tapered Tail .110x.024(2.79x0.61) - Tail LG.=.245(6.22)

THIS IS A C.A.D. GENERATED DRAWING
 DO NOT MAKE MANUAL REVISIONS TO MASTER.



ISSUE NUMBER

ORIGINAL

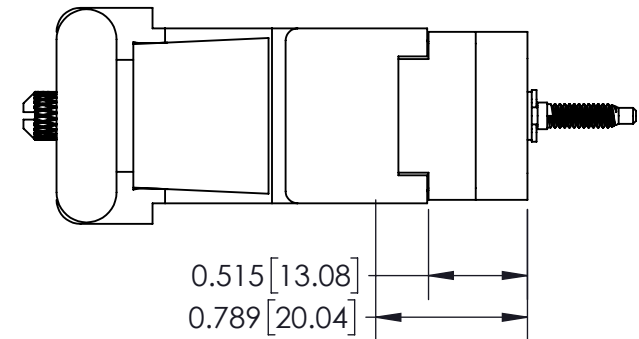
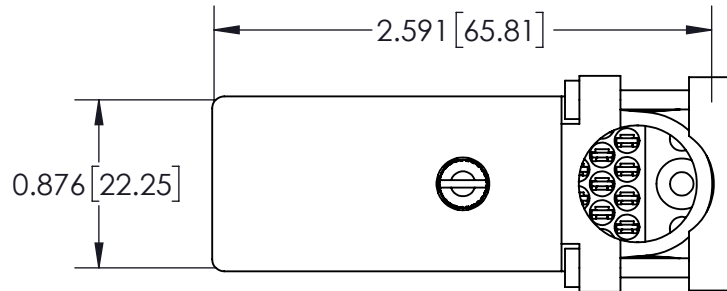

Features

- UL Recognized
- .150 (3.81) Contact Spacing x .130 (3.30) or .150 (3.81) Row Spacing with Staggered Grid
- Plug and Receptacle in 20, 38, 56, 90 or 120 Contact Sizes
- Edacon Hermaphroditic Contact Mating Design
- Contact Termination Options Include: Crimp, P.C. Tail, Wire Hole and Wire Wrap
- Mating and Unmating Simplified with use of Actuating Screws
- Optional Covers with Side or Top Entry Cable Clamp in Plastic or Metal Material Available for All Connector Sizes
- Versatile Metal Cover Design Permits Assembly and Disassembly after Cabling is Complete plus Cable Entry Style Flexibility
- Actuating Screws, Locknuts, Polarizing Hardware, Covers and Contacts Suitable for either Plug or Receptacle
- Polarizing Hardware Adjustable for 288 Mating Combinations
- Tools Available for Contact Installation, Removal and Crimping and Polarizing Changes

Specifications

- Insulator Material: Diallyl Phthalate or Thermo plastic Polyester, UL94V-0, Colour: Green, or Polycarbonate, Colour: Grey
- Contact Material: Phosphor Bronze Alloy CA-510
- Contact Plating: Gold over Nickel for Entire Contact
- Cover Material: Polycarbonate, Colour: Green, or Die-Cast Zinc, Finished with Grey Enamel Paint
- Current Rating: 8.5 Amperes
- Contact Resistance: 10 Milliohms Maximum
- Dielectric Withstanding Voltage: 2000 V AC rms at Sea Level
- Insulation Resistance: 5000 Megohms Minimum
- Operating Temperature: -65 to +125 Degrees C
- Insertion and Withdrawal Force: 2 to 16 oz (0.56 to 4.45 N) per Contact Position

See Accompanying Pages for:
 - PC Tail Layout
 - Cutout Panel Details
 - Cover Details

| | | | |
|--|--|---------------------------------|---------------------|
| 516 Assembly Part Number: 516-056-501-535 | | ACAD REFERENCE NO. 516 Assembly | |
| | | DRAWN: J.LEE | DATE: JUNE 18, 2009 |
|  EDAC INC TORONTO, ONTARIO CANADA YOUR CONNECTION TO QUALITY & SERVICE | | CHECKED: | DATE: |
| | | SCALE: 1:1 | SHEET 1 OF 4 |
| THESE DRAWINGS AND SPECIFICATIONS ARE THE PROPERTY OF EDAC INC. AND SHALL NOT BE REPRODUCED, OR COPIED OR USED AS THE BASIS FOR THE MANUFACTURE OR SALE OF APPARATUS WITHOUT WRITTEN PERMISSION. | | DRAWING NUMBER 516 Assembly | ISSUE 1 |

THIS IS A C.A.D. GENERATED DRAWING
DO NOT MAKE MANUAL REVISIONS TO MASTER.



ISSUE NUMBER

ORIGINAL

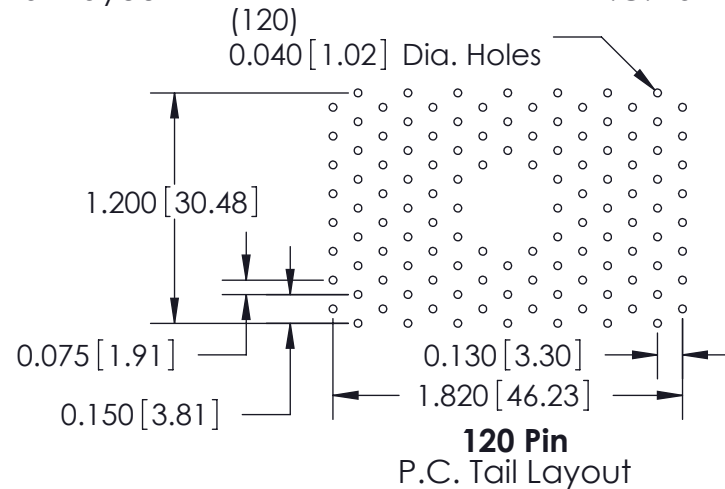
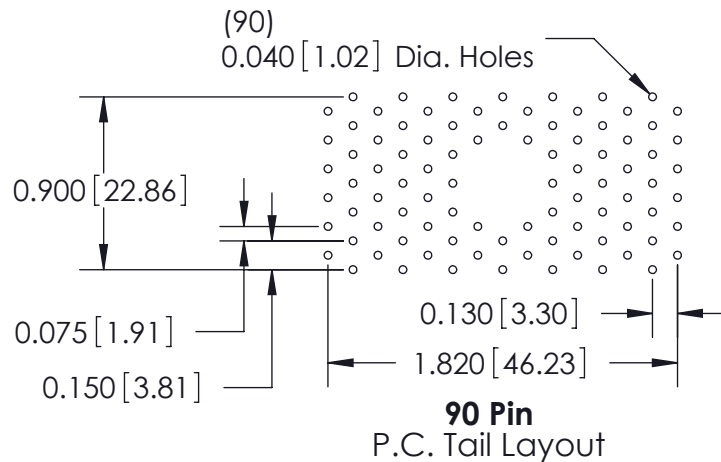
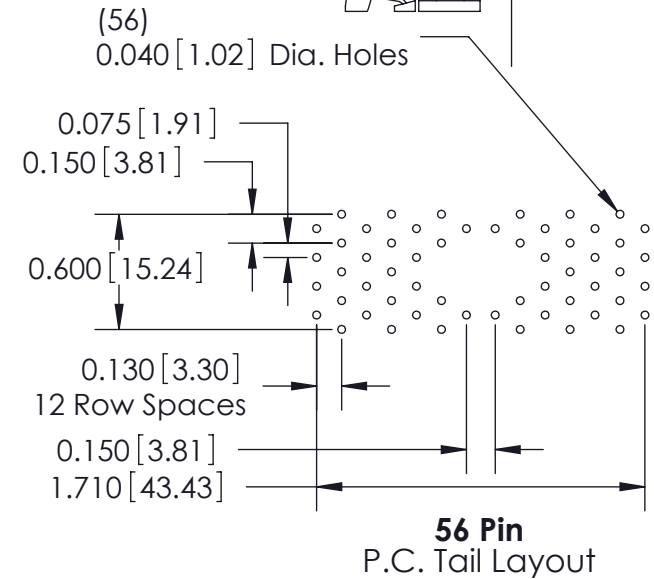
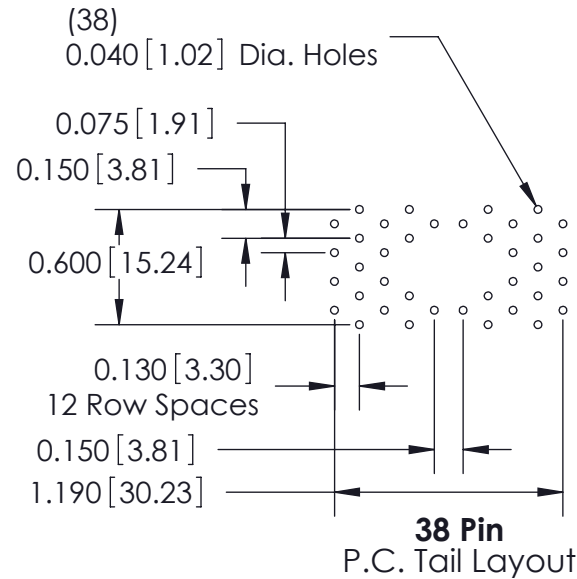
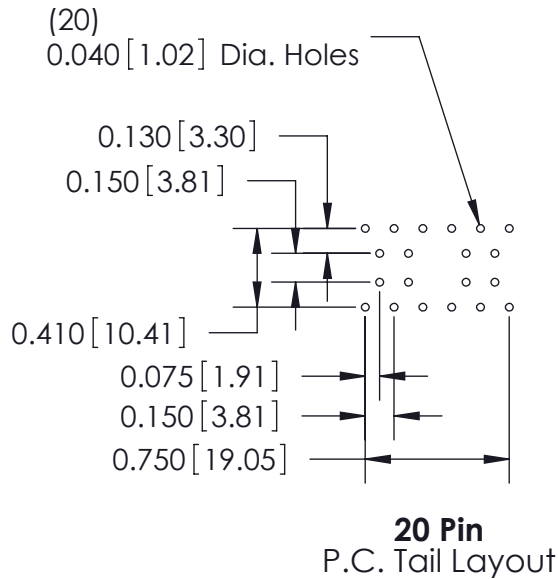

516 Assembly
P.C. Tail Layout Details



EDAC INC
TORONTO, ONTARIO
CANADA

YOUR CONNECTION TO QUALITY & SERVICE

THESE DRAWINGS AND SPECIFICATIONS
ARE THE PROPERTY OF EDAC INC. AND
SHALL NOT BE REPRODUCED, OR COPIED
OR USED AS THE BASIS FOR THE
MANUFACTURE OR SALE OF APPARATUS
WITHOUT WRITTEN PERMISSION.

ACAD REFERENCE NO. 516 Assembly

DRAWN: J.LEE DATE: JUNE 18, 2009

CHECKED: DATE:

SCALE: 1:1 SHEET 2 OF 4

DRAWING NUMBER ISSUE

516 Assembly

1

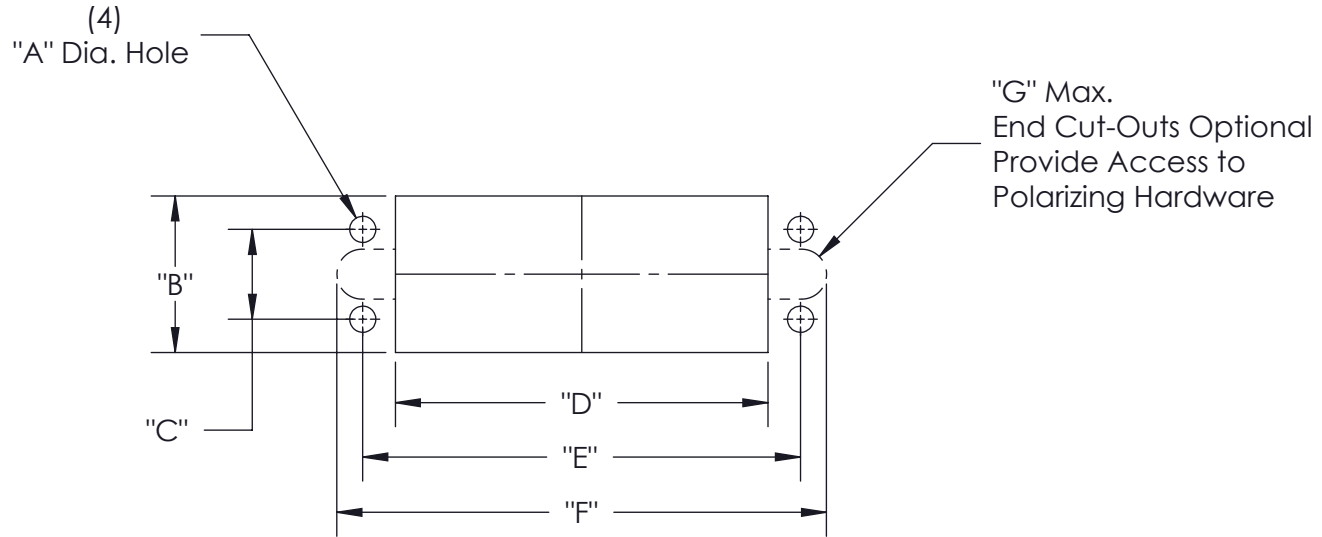

| | Dimension A | Dimension B | Dimension C | Dimension D | Dimension E | Dimension F | Dimension G |
|---------|--------------|---------------|---------------|---------------|---------------|---------------|----------------|
| 20 Pin | 0.104 [2.64] | 0.640 [16.26] | 0.410 [10.41] | 0.960 [24.38] | 1.126 [28.60] | 1.270 [32.26] | R0.130 [R3.30] |
| 38 Pin | 0.136 [3.45] | 0.816 [20.73] | 0.468 [11.89] | 1.420 [36.07] | 1.688 [42.88] | 1.958 [49.73] | R0.130 [R3.30] |
| 56 Pin | 0.136 [3.45] | 0.816 [20.73] | 0.468 [11.89] | 1.940 [49.28] | 2.280 [57.91] | 2.550 [64.77] | R0.130 [R3.30] |
| 90 Pin | 0.136 [3.45] | 1.120 [28.45] | 0.765 [19.43] | 2.050 [52.07] | 2.282 [57.96] | 2.675 [67.95] | R0.130 [R3.30] |
| 120 Pin | 0.136 [3.45] | 1.420 [36.07] | 0.875 [22.23] | 2.050 [52.07] | 2.375 [60.33] | 2.675 [67.95] | R0.130 [R3.30] |

516 Assembly
Cut-Out Panel Detail



EDAC INC
TORONTO, ONTARIO
CANADA

YOUR CONNECTION TO QUALITY & SERVICE

THESE DRAWINGS AND SPECIFICATIONS
ARE THE PROPERTY OF EDAC INC. AND
SHALL NOT BE REPRODUCED, OR COPIED
OR USED AS THE BASIS FOR THE
MANUFACTURE OR SALE OF APPARATUS
WITHOUT WRITTEN PERMISSION.

ACAD REFERENCE NO. 516 Assembly

DRAWN: J.LEE DATE: JUNE 18, 2009

CHECKED: DATE:

SCALE: SHEET 3 OF 4

DRAWING NUMBER

516 Assembly

ISSUE

1

THIS IS A C.A.D. GENERATED DRAWING
DO NOT MAKE MANUAL REVISIONS TO MASTER.



ISSUE NUMBER

ORIGINAL

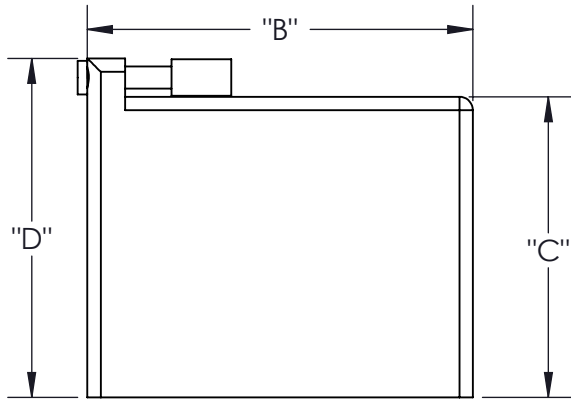

Top Entry

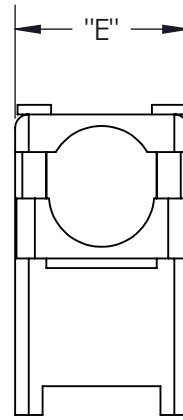

Side Entry



Standard Clamp

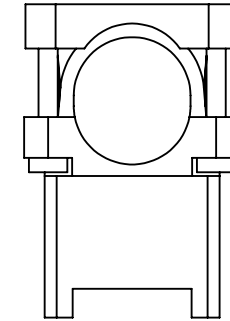

Large Clamp

| Cover for Connector | Cover Material | Clamp Size | "A" | "B" | "C" | "D" | "E" | "F" | "G" |
|---------------------|----------------|------------|---------------|---------------|---------------|---------------|---------------|---------------|---------------|
| 20 Pin | Plastic | Standard | 1.605 (40.77) | 1.325 (33.66) | 0.906 (23.01) | 1.190 (30.23) | 0.715 (18.16) | 0.450 (11.43) | 0.450 (11.43) |
| 20 Pin | Metal | Standard | 1.539 (39.09) | 1.325 (33.66) | 0.906 (23.01) | 1.120 (28.45) | 0.686 (17.42) | 0.446 (11.33) | 0.490 (12.45) |
| 38 Pin | Plastic | Standard | 2.460 (62.48) | 2.010 (51.05) | 1.530 (38.86) | 1.985 (50.42) | 0.910 (23.11) | 0.650 (16.51) | 0.500 (12.70) |
| 38 Pin | Plastic | Large | 2.460 (62.48) | 2.010 (51.05) | 1.530 (38.86) | 1.985 (50.42) | 1.110 (28.19) | 0.650 (16.51) | 0.608 (15.44) |
| 38 Pin | Metal | Standard | 2.206 (56.03) | 2.006 (50.95) | 1.566 (39.78) | 1.766 (44.86) | 0.875 (22.23) | 0.720 (18.29) | 0.575 (14.61) |
| 56 Pin | Plastic | Standard | 2.602 (66.09) | 2.602 (66.09) | 1.530 (38.86) | 1.985 (50.42) | 0.910 (23.11) | 0.650 (16.51) | 0.500 (12.70) |
| 56 Pin | Plastic | Large | 2.602 (66.09) | 2.602 (66.09) | 1.530 (38.86) | 1.985 (50.42) | 1.110 (28.19) | 0.650 (16.51) | 0.608 (15.44) |
| 56 Pin | Metal | Standard | 2.602 (66.09) | 2.602 (66.09) | 1.566 (39.78) | 1.766 (44.86) | 0.875 (22.23) | 0.720 (18.29) | 0.575 (14.61) |
| 90 Pin | Plastic | Standard | 2.718 (69.04) | 2.718 (69.04) | 1.775 (45.09) | 2.181 (55.40) | 1.250 (31.75) | 0.800 (20.32) | 0.800 (20.32) |
| 90 Pin | Metal | Standard | 2.718 (69.04) | 2.718 (69.04) | 1.775 (45.09) | 2.175 (55.25) | 1.234 (31.34) | 0.880 (22.35) | 0.900 (22.86) |
| 120 Pin | Plastic | Standard | 2.750 (69.85) | 2.750 (69.85) | 2.020 (51.31) | 2.426 (61.62) | 1.530 (38.86) | 0.800 (20.32) | 1.080 (27.43) |
| 120 Pin | Metal | Standard | 2.750 (69.85) | 2.750 (69.85) | 2.020 (51.31) | 2.445 (62.10) | 1.531 (38.89) | 0.890 (22.61) | 1.080 (27.43) |

516 Assembly
Cut-Out Panel Detail



YOUR CONNECTION TO QUALITY & SERVICE

EDAC INC
TORONTO, ONTARIO
CANADA

THESE DRAWINGS AND SPECIFICATIONS ARE THE PROPERTY OF EDAC INC. AND SHALL NOT BE REPRODUCED, OR COPIED OR USED AS THE BASIS FOR THE MANUFACTURE OR SALE OF APPARATUS WITHOUT WRITTEN PERMISSION.

ACAD REFERENCE NO. 516 Assembly

DRAWN: J.LEE DATE: JUNE 18, 2009

CHECKED: DATE:

SCALE: SHEET 4 OF 4

DRAWING NUMBER ISSUE

516 Assembly

1