

1 2 3 4 5 6

A

B

C

D

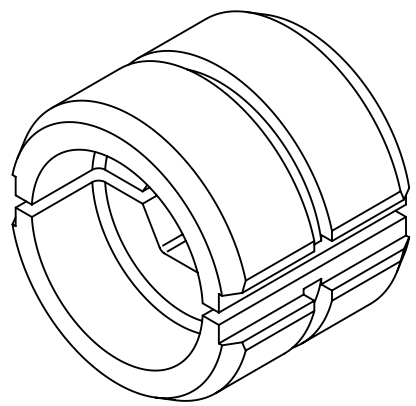
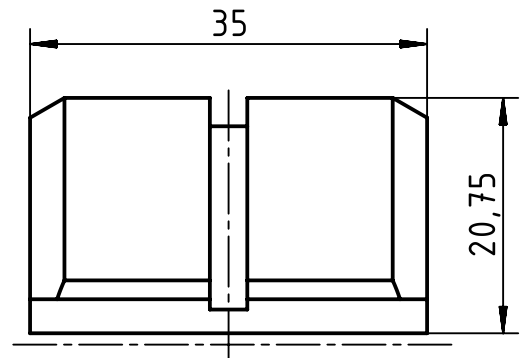
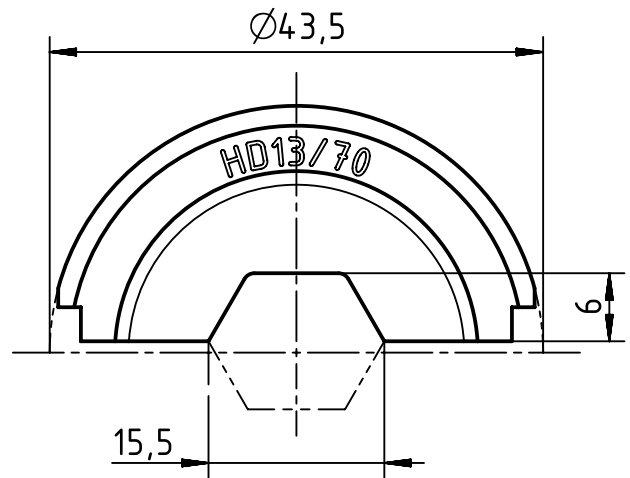
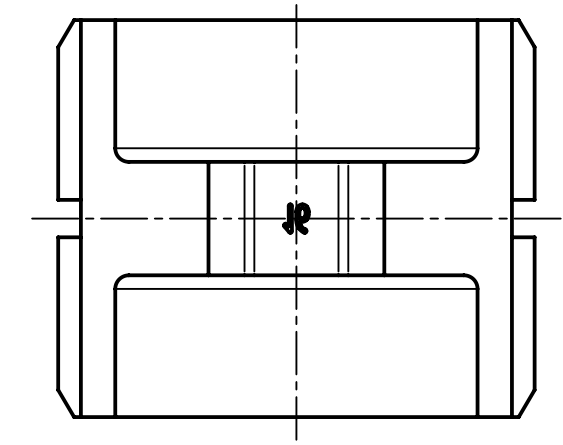

Scope of delivery 2 crimp dies

	All rights reserved Department EL PD - DE	All Dimensions in mm Original Size DIN A4		Scale 1.5:1	Free size tol.	Ref.	
		Created by HOLLERT	Inspected by RIEPE	Standardisation TIEMANNA	Date 2014-11-21	State Final Release	
HARTING Electric GmbH & Co. KG D-32339 Espelkamp		Title Crimp die 70mm <sup>2</sup> for 120 kN tool				Doc-Key / ECM-Nr. 100587236/UGD/002/B 500000081874	
		Type TB	Number 09 99 000 0867			Rev. B	Page 1/1