

Automotive High Temperature SMD Series

Surface Mount



Additional Information



Resources



Accessories



Samples

Description

This Automotive High Temperature SMD is the first miniature high temperature PPTC series from Littelfuse with AEC-Q200 qualification for automotive applications and it provides surface mount overcurrent protection for applications where space is a prime concern and resettable protection is desired.

Features & Benefits

- Meets applicable automotive industry standards
- Compatible with high volume electronics assembly
- Smaller footprint
- High operating temperature -40°C~125°C
- Resettable solution against overcurrent and short circuit
- AEC-Q200 qualified
- RoHS compliant, halogen-free, and lead-free
- Surface-mount form factor
- Expertise from the world's leading resettable overcurrent protection manufacturer
- Provides wider range of form factors to enhance design flexibility
- Meets ever-increasing demand for compact and space saving designs due to more electronics content in vehicle
- Restores system operation after reset when fault condition is removed, thus provides safety and protection
- Able to meet most stringent requirements for the extreme harsh automotive environment
- Suitable for standard PCB assembly to enable automated mass production

Applications

- Automotive and Industrial Transportation
- Infotainment/Telematics
- Climate Control Systems
- Body Electronics
- Sensor Protection
- ADAS (Advanced Driver Assistance)
- Auto Lighting
- Security and Communication Systems

Automotive High Temperature SMD Series

Surface Mount

Electrical Characteristics

Part Number	Ordering Part Number	Size	I_H	I_T	V_{MAX}	I_{MAX}	$P_{D\ Typ}$	Max Time-to-trip		R_{MIN}	R_{1MAX}
			(A)	(A)	(V _{DC})	(A)	(W)	(A)	(s)	(Ω)	(Ω)
Automotive SMD Series											
picoASMDCH005F	RF4927-000	0805	0.05	0.18	16	40	0.60	0.50	0.08	3.50	38.00
picoASMDCH010F	RF4778-000	0805	0.10	0.60	16	40	1.00	2.50	1.50	1.00	10.00
picoASMDCH016F-2	RF5023-000	0805	0.16	0.68	16	40	0.9	8.00	0.10	0.80	6.00
picoASMDCH020F-2	RF4929-000	0805	0.2	0.7	16	40	0.90	8.00	0.10	0.75	3.40
picoASMDCH035F	RF5024-000	0805	0.35	1.10	16	40	0.9	8.00	0.10	0.30	1.90
picoASMDCH050F	RF5025-000	0805	0.50	1.70	16	40	1.5	8.00	0.10	0.25	1.60
nanoASMDCH016F	RF4896-000	1206	0.16	0.80	30	20	0.90	8.00	0.10	0.70	6.00
nanoASMDCH035F	RF4646-000	1206	0.35	0.95	16	50	1.00	3.50	0.20	0.20	1.60
nanoASMDCH035F/30	RF4897-000	1206	0.35	1.75	30	20	1.20	8.00	0.10	0.40	2.20
nanoASMDCH050F/24	RF4914-000	1206	0.50	2.50	24	20	1.70	8.00	0.10	0.20	1.60
miniASMDCH050F	RF4983-000	1812	0.50	1.60	30	20	1.20	8.00	0.10	0.20	1.35
Automotive Terminal SMD Series											
AHS080-2018	RF1640-000	2018	0.80	2.00	16	70	1.5	8.00	9.00	0.13	0.55
AHS120	RF2573-000	2920	1.20	2.30	16	50	2.2	8.00	2.00	0.15	0.34
AHS160	RF1641-000	3425	1.60	3.20	16	70	2.2	8.00	15.00	0.05	0.15
AHS200	RF0422-000	3425	2.00	4.00	16	70	2.3	8.00	13.40	0.05	0.14
AHS300	RF1644-000	3425	3.00	6.00	16	70	3.0	15.00	8.00	0.02	0.08

Notes:
 I_H : Hold current: maximum current device will pass without interruption in 25°C, unless otherwise specified.

 I_T : Trip current: minimum current that will switch the device from low-resistance to high-resistance in 25°C still air, unless otherwise specified.

 V_{MAX} : Maximum voltage device can withstand without damage at rated current.

 I_{MAX} : Maximum fault current device can withstand without damage at rated voltage.

 P_D : Power dissipated from device when in the tripped state in 25°C still air, unless otherwise specified.

 R_{MIN} : Minimum resistance of device as supplied at 25°C, unless otherwise specified.

 R_{1MAX} : Maximum resistance of device when measured one hour post reflow at 25°C unless otherwise specified.

* Electrical characteristics determined at 25°C.

Temperature Derating

Part Number	Maximum Ambient Temperature										
	-40°C	-20°C	0°C	20°C	25°C	40°C	50°C	60°C	70°C	85°C	125°C
Hold Current (A)											
Automotive SMDC Series											
picoASMDCH005F	0.075	0.069	0.060	0.056	0.050	0.048	0.046	0.042	0.040	0.035	0.022
picoASMDCH010F	0.150	0.130	0.115	0.103	0.100	0.090	0.084	0.078	0.072	0.063	0.040
picoASMDCH016F	0.250	0.220	0.200	0.170	0.160	0.150	0.140	0.130	0.110	0.100	0.045
picoASMDCH020F	0.300	0.270	0.240	0.210	0.200	0.180	0.160	0.150	0.130	0.110	0.050
picoASMDCH035F	0.490	0.450	0.400	0.340	0.350	0.310	0.280	0.270	0.230	0.200	0.100
picoASMDCH050F	0.800	0.710	0.640	0.550	0.500	0.480	0.440	0.400	0.360	0.300	0.150
nanoASMDCH016F	0.250	0.210	0.190	0.170	0.160	0.140	0.130	0.120	0.110	0.090	0.050
nanoASMDCH035F	0.540	0.480	0.430	0.370	0.350	0.320	0.290	0.260	0.240	0.200	0.100
nanoASMDCH035F/30	0.510	0.460	0.410	0.360	0.350	0.310	0.290	0.260	0.240	0.200	0.100
nanoASMDCH050F/24	0.730	0.660	0.580	0.500	0.500	0.450	0.420	0.390	0.350	0.310	0.170
miniASMDCH050F	0.750	0.680	0.600	0.520	0.500	0.450	0.410	0.400	0.330	0.280	0.120
Automotive Terminal SMD Series											
AHS080-2018	1.200	1.040	0.900	0.800	0.770	0.680	0.620	0.600	0.530	0.460	0.260
AHS120	1.720	1.540	1.360	1.200	1.140	1.010	0.920	0.830	0.740	0.610	0.250
AHS160	2.150	1.960	1.780	1.600	1.550	1.420	1.330	1.240	1.150	1.010	0.640
AHS200	2.900	2.500	2.200	2.000	1.940	1.800	1.750	1.700	1.400	1.180	0.670
AHS300	4.200	3.800	3.700	3.000	2.920	2.630	2.440	2.100	2.000	1.760	1.000

Automotive High Temperature SMD Series

Surface Mount

Temperature Derating Curve

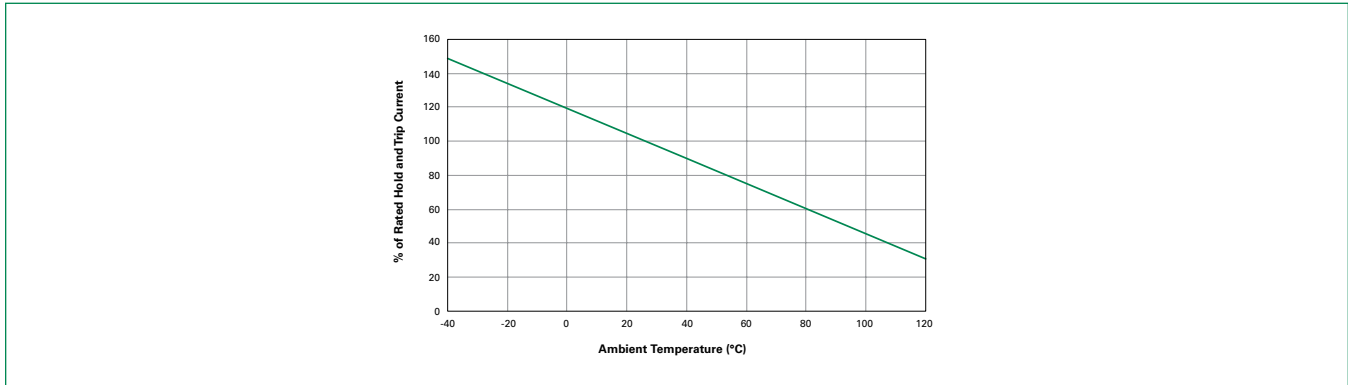

Typical Time-to-Trip Curves at 25°C

Automotive SMDC Series

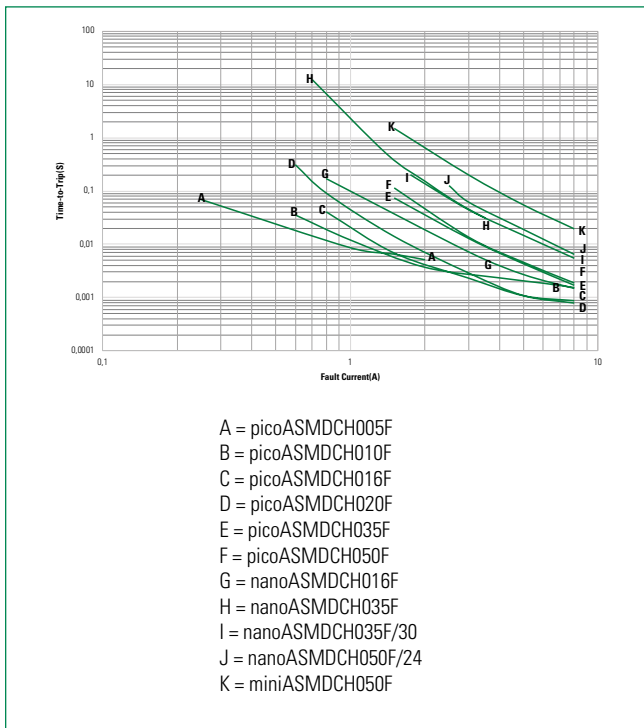

Automotive Terminal SMD Series

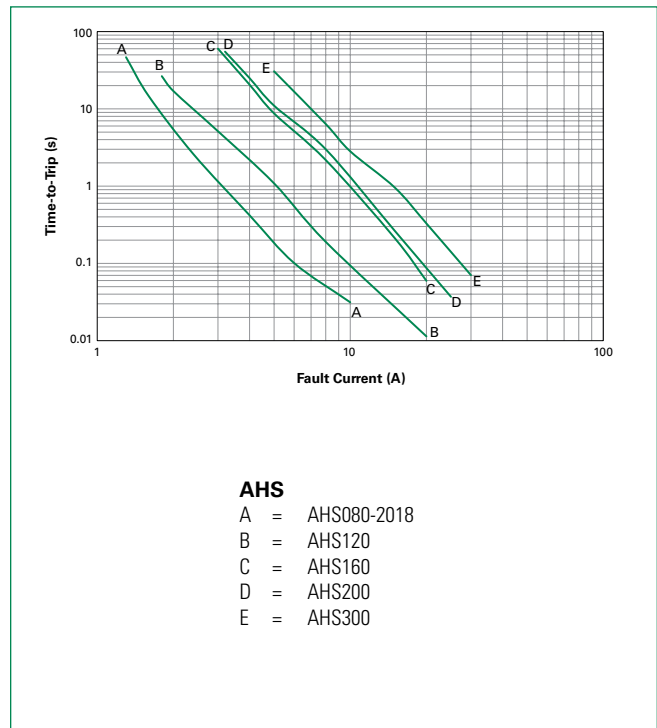

Note: The average time current curves and Temperature Derating curve performance is affected by a number of variables, and these curves provided as guidance only. Customer must verify the performance in their application.

Physical Specifications

Terminal Pad Material	100% Matte Tin with Nickel Underplate
Soldering Characteristics	Solderability per ANSI-J-STD-002 Category 3
Solder Heat Withstand	per IEC-STD 68-2-20, Test Tb, Section 5, Method 1a
Flammability Resistance	per IEC 695-2-2 Needle Flame Test for 20 seconds
Recommended Storage Conditions	40°C max, 70% RH max; Devices May Not Meet Specified Ratings if Storage Conditions are Exceeded
Operation Temperature	-40°C~125°C

Note: See PS400 for other physical specifications.

Automotive High Temperature SMD Series

Surface Mount

Environmental Specifications

Test	Conditions	Resistance Change
Passive Aging	60°C, 1000 hrs, 85°C, 1000 hrs	±3% Typical, ±5% Typical
Humidity Aging	85°C, 85% R.H., 100 hrs	±1.2% Typical
Thermal Shock	125°C, -40°C 10 times	-33% Typical
Solvent Resistance	Freon Trichloroethane Hydrocarbons	No change No change No change

Note: See PS400 for other environmental specifications.

Moisture Resistance Level	Level 2a, J-STD-020
Storage Conditions	40°C max, 70% RH max; devices should remain in original sealed bags prior to use. Devices may not meet specified values if these storage conditions are exceeded.

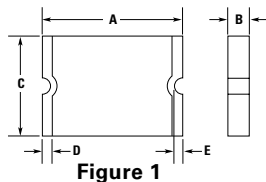

Figure 1

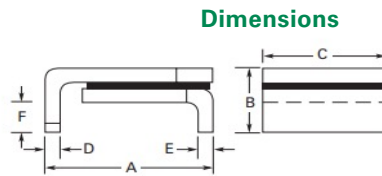

Figure 2

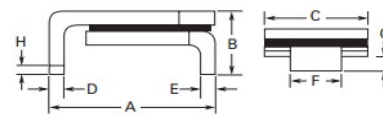

Figure 3

Dimensions

Part Number	Dimensions in Millimeters (Inches)																Figure	
	A		B		C		D		E		F		G		H			
	Min	Max	Min	Max	Min	Max	Min	Max	Min	Max	Min	Max	Min	Max	Min	Max		
Automotive SMDC Series																		
picoASMDCH005F	2.00 (0.079)	2.20 (0.087)	0.40 (0.016)	0.80 (0.031)	1.30 (0.051)	1.50 (0.059)	0.25 (0.010)	0.75 (0.030)	0.08 (0.03)	-	-	-	-	-	-	-	-	1
picoASMDCH010F	2.00 (0.079)	2.20 (0.087)	0.40 (0.016)	0.80 (0.031)	1.30 (0.051)	1.50 (0.059)	0.25 (0.010)	0.75 (0.030)	0.076 (0.003)	-	-	-	-	-	-	-	-	1
picoASMDCH016F	2.00 (0.079)	2.20 (0.087)	0.40 (0.016)	0.80 (0.031)	1.30 (0.051)	1.50 (0.059)	0.25 (0.010)	0.75 (0.030)	0.08 (0.03)	-	-	-	-	-	-	-	-	1
picoASMDCH020F	2.00 (0.079)	2.20 (0.087)	0.40 (0.016)	0.80 (0.031)	1.30 (0.051)	1.50 (0.059)	0.25 (0.010)	0.75 (0.030)	0.08 (0.03)	-	-	-	-	-	-	-	-	1
picoASMDCH035F	2.00 (0.079)	2.20 (0.087)	0.60 (0.024)	1.20 (0.047)	1.30 (0.051)	1.50 (0.059)	0.25 (0.010)	0.75 (0.030)	0.08 (0.03)	-	-	-	-	-	-	-	-	1
picoASMDCH050F	2.00 (0.079)	2.20 (0.087)	0.60 (0.024)	1.20 (0.047)	1.30 (0.051)	1.50 (0.059)	0.25 (0.010)	0.75 (0.030)	0.08 (0.03)	-	-	-	-	-	-	-	-	1
nanoASMDCH016F	3.00 (0.118)	3.40 (0.134)	0.61 (0.024)	0.89 (0.035)	1.37 (0.054)	1.80 (0.071)	0.25 (0.010)	0.75 (0.030)	0.076 (0.003)	-	-	-	-	-	-	-	-	1
nanoASMDCH035F	3.00 (0.118)	3.40 (0.134)	0.91 (0.036)	1.14 (0.045)	1.37 (0.054)	1.80 (0.071)	0.25 (0.010)	0.75 (0.030)	0.076 (0.003)	-	-	-	-	-	-	-	-	1
nanoASMDCH035F/30	3.00 (0.118)	3.40 (0.134)	1.16 (0.046)	1.46 (0.057)	1.37 (0.054)	1.80 (0.071)	0.25 (0.010)	0.75 (0.030)	0.076 (0.003)	-	-	-	-	-	-	-	-	1
nanoASMDCH050F/24	3.00 (0.118)	3.40 (0.134)	1.16 (0.046)	1.46 (0.057)	1.37 (0.054)	1.80 (0.071)	0.25 (0.010)	0.75 (0.030)	0.076 (0.003)	-	-	-	-	-	-	-	-	1
miniASMDCH050F	4.37 (0.172)	4.83 (0.190)	0.5 (0.023)	0.82 (0.032)	3.07 (0.121)	3.41 (0.134)	0.25 (0.010)	0.95 (0.040)	0.2 (0.008)	-	-	-	-	-	-	-	-	1
Automotive Terminal SMD Series																		
AHS080-2018	4,72 (0,186)	5,44 (0,214)	-	1,52 (0,060)	4,22 (0,166)	4,93 (0,194)	0,25 (0,010)	0,36 (0,014)	0,25 (0,010)	0,36 (0,014)	0,30 (0,012)	0,46 (0,018)	-	-	-	-	-	2
AHS120	6,73 (0,265)	7,98 (0,314)	-	3,00 (0,118)	4,80 (0,190)	5,44 (0,214)	0,56 (0,022)	0,71 (0,028)	0,56 (0,022)	0,71 (0,028)	2,16 (0,085)	2,41 (0,095)	0,66 (0,026)	1,37 (0,054)	0,43 (0,017)	-	-	3
AHS160	8,00 (0,315)	9,40 (0,370)	-	3,00 (0,118)	6,00 (0,240)	6,71 (0,264)	0,56 (0,022)	0,71 (0,028)	0,56 (0,022)	0,71 (0,028)	3,68 (0,145)	3,94 (0,155)	0,66 (0,026)	1,37 (0,054)	0,43 (0,017)	-	-	3
AHS200	8,00 (0,315)	9,40 (0,370)	-	3,00 (0,118)	6,00 (0,240)	6,71 (0,264)	0,56 (0,022)	0,71 (0,028)	0,56 (0,022)	0,71 (0,028)	3,68 (0,145)	3,94 (0,155)	0,66 (0,026)	1,37 (0,054)	0,43 (0,017)	-	-	3
AHS300	8,00 (0,315)	9,40 (0,370)	-	3,00 (0,118)	6,00 (0,240)	6,71 (0,264)	0,56 (0,022)	0,71 (0,028)	0,56 (0,022)	0,71 (0,028)	3,68 (0,145)	3,94 (0,155)	0,66 (0,026)	1,37 (0,054)	0,43 (0,017)	-	-	3

Automotive High Temperature SMD Series

Surface Mount

Recommended Pad Layout

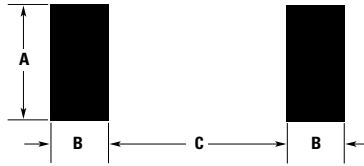

Packaging and Marking Information

Part Number	Tape and Reel Quantity	Standard Package	Part Marking	Recommended Pad Layout Figures [mm (in)]			Agency Recognition
				Dimension A (Nom)	Dimension B (Nom)	Dimension C (Nom)	
Automotive SMDC Series							
picoASMDCH005F	4000	20000	A	1.50 (0.060)	1.00 (0.039)	1.20 (0.047)	-
picoASMDCH010F	4000	20000	L	1.50 (0.060)	1.00 (0.039)	1.20 (0.047)	-
picoASMDCH016F	4000	20000	T	1.50 (0.060)	1.00 (0.039)	1.20 (0.047)	-
picoASMDCH020F	4000	20000	Y	1.50 (0.060)	1.00 (0.039)	1.20 (0.047)	-
picoASMDCH035F	3000	15000	B	1.50 (0.060)	1.00 (0.039)	1.20 (0.047)	-
picoASMDCH050F	3000	15000	P	1.50 (0.060)	1.00 (0.039)	1.20 (0.047)	-
nanoASMDCH016F	3000	15000	H16	1.60 (0.063)	1.00 (0.039)	2.00 (0.079)	-
nanoASMDCH035F	3000	15000	H35	1.60 (0.063)	1.00 (0.039)	2.00 (0.079)	-
nanoASMDCH035F/30	3000	15000	V	1.60 (0.063)	1.00 (0.039)	2.00 (0.079)	-
nanoASMDCH050F/24	3000	15000	H50	1.60 (0.063)	1.00 (0.039)	2.00 (0.079)	-
miniASMDCH050F	2000	10000	H050F	3.15 (0.124)	1.68 (0.066)	3.10 (0.122)	-
Automotive Terminal SMD Series							
AHS080-2018	4000	20000	H08	4.6 (0.18)	1.5 (0.06)	3.4 (0.134)	-
AHS120	2000	10000	H12	3.1 (0.12)	2.3 (0.09)	5.1 (0.201)	-
AHS160	1500	7500	160	4.6 (0.18)	2.3 (0.09)	6.1 (0.240)	-
AHS200	1500	7500	H200	4.6 (0.18)	2.3 (0.09)	6.1 (0.240)	-
AHS300	1500	7500	H300	4.6 (0.18)	2.3 (0.09)	6.1 (0.240)	-

Solder Reflow Recommendations

Profile Feature	Pb-Free Assembly
Average ramp up rate (T_{s_MAX} to T_p)	3°C/s max
Preheat	
• Temperature min (T_{s_MIN})	150°C
• Temperature max (T_{s_MAX})	200°C
• Time (t_{s_MIN} to t_{s_MAX})	60-120 s
Time maintained above:	
• Temperature (T_L)	217°C
• Time (t_L)	60-150 s
Peak/Classification temperature (T_p)	260°C
Time within 5°C of actual peak temperature	
Time (t_p)	30 s max
Ramp down rate	3°C/s max
Time 25°C to peak temperature	8 min max

Note: All temperatures refer to topside of the package, measured on the package body surface.

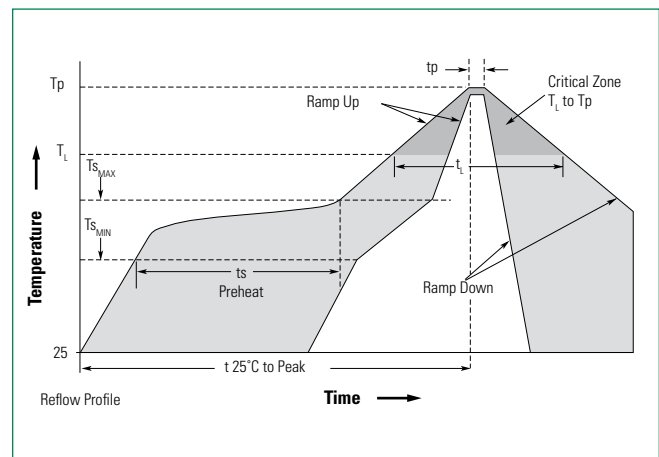

Automotive High Temperature SMD Series

Surface Mount

Solder Reflow

- Recommended reflow method: IR, hot air, nitrogen.
- Recommended maximum paste thickness: 0.25mm (0.010in)
- Devices can be cleaned using standard methods and aqueous solvents.
- Experience has shown the optimum conditions for forming acceptable solder fillets occur when a reasonable amount of solder paste is placed underneath each device's termination. As such, we request that customers comply with our recommended solder pad layouts.
- Customer should validate that the solder paste amount and reflow recommendations meet its application.
- We request that customer board layouts refrain from placing raised features (e.g. vias, nomenclature, traces, etc.) underneath PolySwitch devices. It is possible that raised features could negatively impact solderability performance of our devices.

Rework

- Standard industry practices. (Please also avoid direct contact to the device.)

Part Number System

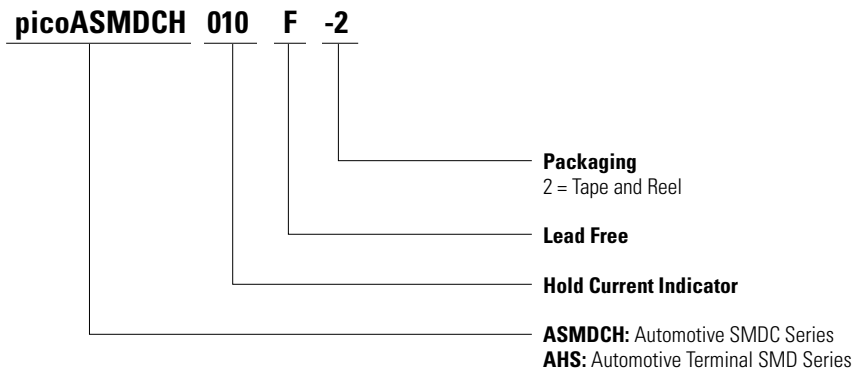

Automotive High Temperature SMD Series

Surface Mount

Tape and Reel Diagrams

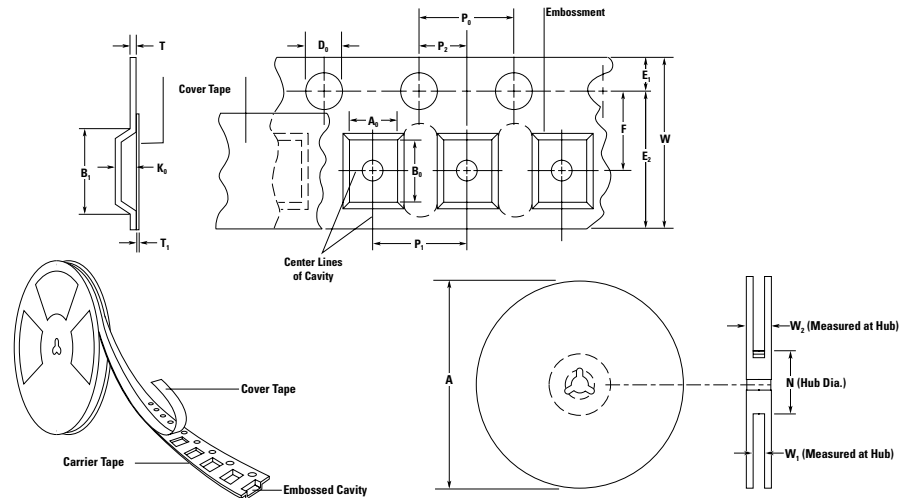

Warning:

- Users should independently evaluate the suitability of and test each product selected for their own application.
- Operation beyond the maximum ratings or improper use may result in device damage and possible electrical arcing and flame.
- These devices are intended for protection against damage caused by occasional overcurrent or overtemperature fault conditions and should not be used when repeated fault conditions or prolonged trip events are anticipated.
- Contamination of the PPTC material with certain silicone-based oils or some aggressive solvents can adversely impact the performance of the devices.
- Device performance can be impacted negatively if devices are handled in a manner inconsistent with recommended electronic, thermal, and mechanical procedures for electronic components.
- PPTC devices are not recommended for installation in applications where the device is constrained such that its PTC properties are inhibited, for example in rigid potting materials or in rigid housings, which lack adequate clearance to accommodate device expansion.
- Operation in circuits with a large inductance can generate a circuit voltage (Ldi/dt) above the rated voltage of the device.

Tape and Reel Specifications

Description	Automotive SMDC Series				Automotive Terminal SMD Series		
	picoASMDCH016F picoASMDCH005F picoASMDCH010F picoASMDCH020F picoASMDCH035F picoASMDCH050F	nanoASMDCH016F nanoASMDCH035F	nanoASMDCH035F/30 nanoASMDCH050F/24	miniASMDCH050F	AHS080-2018	AHS120	AHS160 AHS200 AHS300
W	8.0 ± 0.30	8.0 ± 0.30	8.0 ± 0.30	12.0 ± 0.30	16.0 ± 0.30	16.0 ± 0.30	16.0 ± 0.30
P₀	4.0 ± 0.10	4.0 ± 0.10	4.0 ± 0.10	4.0 ± 0.10	4.0 ± 0.10	4.0 ± 0.10	4.0 ± 0.10
P₁	4.0 ± 0.10	4.0 ± 0.10	4.0 ± 0.10	8.0 ± 0.10	8.0 ± 0.10	8.0 ± 0.10	12.0 ± 0.10
P₂	2.0 ± 0.10	2.0 ± 0.05	2.0 ± 0.05	2.0 ± 0.05	2.0 ± 0.10	2.0 ± 0.10	2.0 ± 0.10
A₀	1.70 ± 0.1	1.95 ± 0.1	1.95 ± 0.1	3.5 ± 0.1	5.11 ± 0.15	5.6 ± 0.23	6.9 ± 0.23
B₀	2.45 ± 0.1	3.5 ± 0.1	3.5 ± 0.1	4.95 ± 0.1	5.6 ± 0.23	8.1 ± 0.15	9.6 ± 0.15
B₁ max	4.35	4.35	4.35	6.15	12,1	12,1	12,1
D₀	1.55 ± .05	1.55 ± .05	1.55 ± .05	1.5 + 0.10/-.00	1.5 + 0.10/-.00	1.5 + 0.10/-.00	1.5 + 0.10/-.00
F	3.50 ± 0.05	3.50 ± 0.05	3.50 ± 0.05	5.50 ± 0.05	7.50 ± 0.10	7.50 ± 0.10	7.50 ± 0.10
E₁	1.75 ± 0.10	1.75 ± 0.10	1.75 ± 0.10	1.75 ± 0.10	1.75 ± 0.10	1.75 ± 0.10	1.75 ± 0.10
E₂ min	6.25	6.25	6.25	10.25	14,25	14,25	14,25
T max	0.3	0.6	0.6	0.35	0,4	0,4	0,4
T₁ max	0.1	0.1	0.1	0.1	0,1	0,1	0,1
K₀	0.86 ± 0.1	1.27 ± 0.1	1.50 ± 0.1	0.9 ± 0.1	1.8 ± 0.15	3.2 ± 0.15	3.4 ± 0.15
A max	185	185	185	185	330	330	330
N min	50	50	50	50	50	50	50
W₁	8.4 + 1.5/-0.0	8.4 + 1.5/-0.0	8.4 + 1.5/-0.0	12.4 + 2.0/-0.0	16.4 + 2.0/-0.0	16.4 + 2.0/-0.0	16.4 + 2.0/-0.0
W₂ max	14.4	14.4	14.4	18.4	22,4	22,4	22,4

Disclaimer Notice - Information furnished is believed to be accurate and reliable. However, users should independently evaluate the suitability of and test each product selected for their own applications. Littelfuse products are not designed for, and may not be used in, all applications. Read complete Disclaimer Notice at www.littelfuse.com/disclaimer-electronics.