

【 1. 適用範囲 SCOPE】

本仕様書は、_____ 殿 に納入する
0.5mm ピッチ FFC 対 基板 用 コネクタ について規定する。
 This specification covers the 0.5mm PITCH FFC TO BOARD CONNECTOR series

【 2. 製品名称及び型番 PRODUCT NAME AND PART NUMBER】

製品名称 Product Name		製品型番 Material Number
コネクタ側 Connector Side	ハウジングアッセンブリ Housing Assembly (ST Type)	501786-**11
	501786-**11 テーピング梱包 Embossed Tape Package for 501786-**11	501786-**90
プラグ側 Plug Side	プラグジャケット Plug Jacket	501783-**09
	プラグジャケットカバー Plug Jacket Cover	501784-**09

* : 図面参照 Refer to the drawings.

・ジャケット、ジャケットカバー対応表 CORRESPONDENCE TABLE

製品名称(テーピング梱包) Product Name(Embossed Tape Package)	プラグジャケット Plug Jacket	プラグジャケットカバー Plug Jacket Cover
501786-5090	501783-5009	501784-5009
501786-8090	501783-8009	501784-8009

REV.	A	B	C	D	E			
SHEET	1~17	1~17	1-17	1-17	1-21			
REVISE ON PC ONLY					TITLE: 0.5 mm PITCH FFC TO BOARD CONNECTOR 製品仕様書			
E	変更 REVISED J2016-0602 '15/12/11 A.OKAJIMA							
THIS DOCUMENT CONTAINS INFORMATION THAT IS PROPRIETARY TO MOLEX ELECTRONIC TECHNOLOGIES, LLC AND SHOULD NOT BE USED WITHOUT WRITTEN PERMISSION								
REV.	DESCRIPTION							
DESIGN CONTROL J			STATUS		WRITTEN BY: H.IIJIMA	CHECKED BY: K.TAKAHASHI	APPROVED BY: H.HIRATA	DATE: YR/MO/DAY 2005/10/20
DOCUMENT NUMBER PS-501786-001							FILE NAME PS501786001.docx	SHEET 1 OF 21
EN-037(2015-11 rev.1)								

【 3. 定格 RATINGS 】

項 目 Item	規 格 Standard	
最大許容電圧 Rated Voltage (MAX.)	50 V ^{*2}	[AC (実効値 rms) /DC]
最大許容電流 Rated Current (MAX.)	0.5 A ^{*2}	
使用温度範囲 Ambient Temperature Range	-40°C ~ +105°C ^{*1*2*3}	

*1 : 通電による温度上昇分を含む。

Including terminal temperature rise.

*2 : 使用FFCも本定格を満足すること。

FFC must be met ratings specified in this standard.

*3 : 8-4を参照のこと。

See for details 8-4

E	REVISE ON PC ONLY	TITLE: 0.5 mm PITCH FFC TO BOARD CONNECTOR 製品仕様書
	SEE SHEET 1 OF 21	
REV.	DESCRIPTION	THIS DOCUMENT CONTAINS INFORMATION THAT IS PROPRIETARY TO MOLEX ELECTRONIC TECHNOLOGIES, LLC AND SHOULD NOT BE USED WITHOUT WRITTEN PERMISSION
DOCUMENT NUMBER PS-501786-001		FILE NAME PS501786001.docx
		SHEET 2 OF 21
EN-037(2015-11 rev.1)		

【 4. 性 能 PERFORMANCE】

4-1. 電氣的性能 Electrical Performance

項 目 Item		条 件 Test Condition	規 格 Requirement
4-1-1	接 触 抵 抗 Contact Resistance	適合FFCハーネスを嵌合させ、開放電圧 20mV 以下、 短絡電流 10mA 以下 にて測定する。 (JIS C5402 5.4) Mate applicable FFC Harness, measure by dry circuit, 20mV MAX., 10mA MAX. (JIS C5402 5.4)	40 milliohm MAX.
4-1-2	絶 縁 抵 抗 Insulation Resistance	適合FFCハーネスを嵌合させ、隣接するターミナル間 及びターミナル、アース間に、DC 500V を印加し測定 する。 (JIS C5402 5.2/MIL-STD-202 試験法 302) Mate applicable FFC Harness and apply 500V DC between adjacent terminal and ground. (JIS C5402 5.2/MIL-STD-202 Method 302)	50 Megohm MIN.
4-1-3	耐 電 圧 Dielectric Strength	適合FFCハーネスを嵌合させ、隣接するターミナル間 及びターミナル、アース間に、AC 250V (実効値) を 1 分間 印加する。 (JIS C5402 5.1/MIL-STD-202 試験法 301) Mate applicable FFC Harness, apply 250V AC (rms) for 1 minute between adjacent terminal or ground. (JIS C5402 5.1/MIL-STD-202 Method 301)	異状なきこと No Breakdown

4-2. 機械的性能 Mechanical Performance

項 目 Item		条 件 Test Condition	規 格 Requirement
4-2-1	挿入・抜去力 Insertion Force/ Withdrawal Force	ロックを解除した状態にて、毎分 25±3 mm の 速さで挿入・抜去を行う。 Insert and withdraw connectors, at the speed rate of 25+/-3 mm per minute.	第6項参照 Refer to paragraph 6
4-2-2	強制抜去力 Compulsion Withdrawal Force	適合FFCハーネスを嵌合させ、ロックを解除せず に毎分 25±3 mm の速さで軸方向にを引き抜く。 Mate applicable FFC Harness, apply axial pull out force at the speed rate of 25+/-3 mm per minute.	9.8 N{ 1.0 kgf} MINIMUM

REVISE ON PC ONLY	
E	SEE SHEET 1 OF 21
REV.	DESCRIPTION

TITLE:
0.5 mm PITCH FFC TO BOARD CONNECTOR
製品仕様書

THIS DOCUMENT CONTAINS INFORMATION THAT IS PROPRIETARY TO MOLEX ELECTRONIC TECHNOLOGIES, LLC AND SHOULD NOT BE USED WITHOUT WRITTEN PERMISSION

DOCUMENT NUMBER
PS-501786-001

FILE NAME
PS501786001.docx

SHEET
3 OF 21

4-3. その他 Environmental Performance and Others

項目 Item		条件 Test Condition	規格 Requirement	
4-3-1	繰り返し挿抜 Repeated Mate / Un-mate	無通電状態にて、1分間に 10回以下の速さで挿入、抜去を 20回 繰り返す。 When mated up to 20 cycles repeatedly at the speed rate of less than 10 cycles per minute.	接触抵抗 Contact Resistance	60 milliohm MAX.
4-3-2	温度上昇 Temperature Rise	適合FFCハーネスを嵌合させ、最大許容電流を通電し、コネクタの温度上昇分を測定する。 (UL 498) Carrying rated current load. (UL 498)	温度上昇 Temperature Rise	30 °C MAX.
4-3-3	耐振動性 Vibration	DC 1mA 通電状態にて、嵌合軸を含む互いに垂直な 3方向 に掃引割合 10~55~10Hz/分、全振幅 1.5mm の振動を 各2時間 加える。 (MIL-STD-202試験法 201) Amplitude : 1.5 mm P-P Sweep time : 10-55-10 Hz in 1 minutes Duration : 2 hours in each X.Y.Z axes (MIL-STD-202, Method 201)	外観 Appearance	異常なきこと No Damage
			接触抵抗 Contact Resistance	60 milliohm MAX.
			瞬断 Discontinuity	1 microsecond MAX
4-3-4	耐衝撃性 Shock	DC 1mA 通電状態にて、嵌合軸を含む互いに垂直な 6方向 に 490m/s ² {50G} の衝撃を 各3回 加える。 (JIS C041 / MIL-STD-202試験法 213) 490m/s ² {50 G}, 3 strokes in each X.Y.Z. axes. (JIS C0041/MIL-STD-202 Method 213)	外観 Appearance	異常なきこと No Damage
			接触抵抗 Contact Resistance	60 milliohm MAX.
			瞬断 Discontinuity	1 microsecond MAX.
4-3-5	耐熱性 Heat Resistance	適合FFCハーネスを嵌合させ、105±2°C の雰囲気中に96時間 放置後取り出し、1~2時間 室温に放置する。 (JIS C0021/MIL-STD-202 試験法 108) 105+/-2 degree C, 96 hours (JIS C0021/MIL-STD-202 Method 108)	外観 Appearance	異常なきこと No Damage
			接触抵抗 Contact Resistance	60 milliohm MAX.

REVISE ON PC ONLY

E

SEE SHEET 1 OF 21

TITLE:

0.5 mm PITCH FFC TO BOARD CONNECTOR

製品仕様書

THIS DOCUMENT CONTAINS INFORMATION THAT IS PROPRIETARY TO MOLEX ELECTRONIC TECHNOLOGIES, LLC AND SHOULD NOT BE USED WITHOUT WRITTEN PERMISSION

REV.

DESCRIPTION

DOCUMENT NUMBER
PS-501786-001

FILE NAME
PS501786001.docx

SHEET
4 OF 21

項目 Item		条件 Test Condition	規格 Requirement	
4-3-6	耐寒性 Cold Resistance	適合FFCハーネスを嵌合させ、 $-40\pm 2^{\circ}\text{C}$ の霧囲気中に96時間 放置後取り出し、1~2時間 室温に放置する。 (JIS C0020) -40+/-2 degree C, 96 hours (JIS C0020)	外観 Appearance	異常なきこと No Damage
			接触抵抗 Contact Resistance	60 milliohm MAX.
4-3-7	耐湿性 Humidity	適合FFCハーネスを嵌合させ、 $60\pm 2^{\circ}\text{C}$ 相対湿度 90~95% の霧囲気中に 96時間 放置後取り出し、1~2時間 室温に放置する。 (JIS C0022/MIL-STD-202 試験方法103) Temperature: 60+/-2 degree C Relative Humidity: 90-95% Duration: 500 hours (JIS C0022/MIL-STD-202 Method 103)	外観 Appearance	異常なきこと No Damage
			接触抵抗 Contact Resistance	60 milliohm MAX.
			耐電圧 Dielectric Strength	4-1-3項満足のこと Must meet 4-1-3
			絶縁抵抗 Insulation Resistance	20 Megohm MIN.
4-3-8	温度サイクル Temperature Cycling	適合FFCハーネスを嵌合させ、 $-40\pm 3^{\circ}\text{C}$ に30分、 $+105\pm 2^{\circ}\text{C}$ に 30分、これを 1サイクル とし、5サイクル 繰り返す。 但し、温度移行時間は 5分以内 とする。 試験後 1~2時間 室温に放置する。 (JIS C60068) 5 cycles of : a) $-40+/-3$ degree C : 30minutes b) $+105+/-2$ degree C : 30minutes (JIS C60068)	外観 Appearance	異常なきこと No Damage
			接触抵抗 Contact Resistance	60 milliohm MAX.

REVISE ON PC ONLY

E

SEE SHEET 1 OF 21

TITLE:

0.5 mm PITCH FFC TO BOARD CONNECTOR

製品仕様書

THIS DOCUMENT CONTAINS INFORMATION THAT IS PROPRIETARY TO MOLEX ELECTRONIC TECHNOLOGIES, LLC AND SHOULD NOT BE USED WITHOUT WRITTEN PERMISSION

REV.

DESCRIPTION

DOCUMENT NUMBER
PS-501786-001

FILE NAME
PS501786001.docx

SHEET
5 OF 21

molex PRODUCT SPECIFICATION

LANGUAGE

JAPANESE
ENGLISH

項目 Item		条件 Test Condition	規格 Requirement	
4-3-9	亜硫酸ガス SO ₂ Gas	適合FFCハーネスを嵌合させ、40±2℃にて50±5ppmの亜硫酸ガス中に24時間放置する。 24 hours exposure to 50+/-5ppm. SO ₂ gas at 40+/-2 degree C	接触抵抗 Contact Resistance	60 milliohm MAX.
4-3-10	耐アンモニア性 NH ₃ Gas	適合FFCハーネスを嵌合させ、濃度28%のアンモニア水を入れた容器中に40分間放置する。 (1Lに対して25mLの割合) 40 minutes exposure to NH ₃ gas evaporating from 28% Ammonia solution.	接触抵抗 Contact Resistance	60 milliohm MAX.
4-3-11	半田付け性 Solder Ability	端子先端より0.3mm、金具先端より0.3mmの位置まで、245±3℃の半田に3±0.5秒浸す。 Soldering Time : 3+/-0.5 seconds Solder Temperature : 245+/-3 degree C 0.3mm from terminal tip. 0.3mm from fitting nail tip.	濡れ性 Solder Wetting	浸漬面積の75%以上 75% of immersed area must show no voids, pin holes.
4-3-12	半田耐熱性 Resistance to Soldering Heat	(リフロー時) 第7項参照。 (When reflowing) Refer to paragraph 7.	外観 Appearance	端子ガタ、割れ等 異状無き事 No Damage
		(手半田) 端子先端より0.3mm、金具先端より0.3mmの位置まで350±10℃の半田ゴテにて5秒加熱する。 (Soldering iron method) Solder time : 5 seconds Solder temperature : 350+/-10 degree C 0.3mm from terminal tip. 0.3mm from fitting nail tip.		

() : 参考規格 Reference Standard
{ } : 参考単位 Reference Unit

REVISE ON PC ONLY		TITLE: 0.5 mm PITCH FFC TO BOARD CONNECTOR 製品仕様書	THIS DOCUMENT CONTAINS INFORMATION THAT IS PROPRIETARY TO MOLEX ELECTRONIC TECHNOLOGIES, LLC AND SHOULD NOT BE USED WITHOUT WRITTEN PERMISSION
E	SEE SHEET 1 OF 21		
REV.	DESCRIPTION		
DOCUMENT NUMBER PS-501786-001		FILE NAME PS501786001.docx	SHEET 6 OF 21
EN-037(2015-11 rev.1)			

【 5. 外観形状、寸法及び材質 PRODUCT SHAPE, DIMENSIONS AND MATERIALS】

図面参照 Refer to the drawing.

【 6. 挿入・抜去力 INSERTION FORCE/WITHDRAWAL FORCE】

下記の F F C を使用した場合のテストデータ（参考）
This test data in case of used the following FFC(Reference)

F F C : 住友電気工業株式会社 製
FFC : SUMITOMO ELECTRIC INDUSTRIES, LTD.
厚さ（導体部） : 0.3 mm
Thickness (CONDUCTOR AREA) : 0.3 mm

(N=5)

極数 No.	of CKT	単位 UNIT	挿入力 Retention Force			抜去力 Withdrawal Force		
			平均値 AVG.	最大値 MAX.	最小値 MIN.	平均値 AVG.	最大値 MAX.	最小値 MIN.
50	初回 1st	N {kgf}	12.02 {1.23}	13.2 {1.35}	11.0 {1.12}	10.26 {1.05}	10.9 {1.11}	9.6 {0.98}
	10回目 10th	N {kgf}	11.44 {1.17}	12.7 {1.30}	10.0 {1.02}	9.44 {0.96}	10.2 {1.04}	9.2 {0.94}
	20回目 20th	N {kgf}	11.70 {1.19}	13.0 {1.33}	10.3 {1.05}	9.8 {1.00}	10.6 {1.08}	9.3 {0.95}
80	初回 1st	N {kgf}	19.25 {1.96}	20.1 {2.05}	18.4 {1.88}	11.30 {1.15}	12.6 {1.29}	10.7 {1.09}
	10回目 10th	N {kgf}	18.95 {1.96}	19.8 {2.02}	17.5 {8.75}	11.63 {1.18}	12.6 {1.29}	10.9 {1.11}
	20回目 20th	N {kgf}	18.78 {1.92}	19.8 {2.02}	17.6 {1.80}	12.25 {1.25}	13.3 {1.36}	11.5 {1.17}

* ,50極は80極データからの想定値となります。

REVISE ON PC ONLY		TITLE: 0.5 mm PITCH FFC TO BOARD CONNECTOR 製品仕様書
E	SEE SHEET 1 OF 21	
REV.	DESCRIPTION	THIS DOCUMENT CONTAINS INFORMATION THAT IS PROPRIETARY TO MOLEX ELECTRONIC TECHNOLOGIES, LLC AND SHOULD NOT BE USED WITHOUT WRITTEN PERMISSION
DOCUMENT NUMBER PS-501786-001		FILE NAME PS501786001.docx
		SHEET 7 OF 21
EN-037(2015-11 rev.1)		

【 7. 推奨温度プロファイル REFLOW CONDITION 】

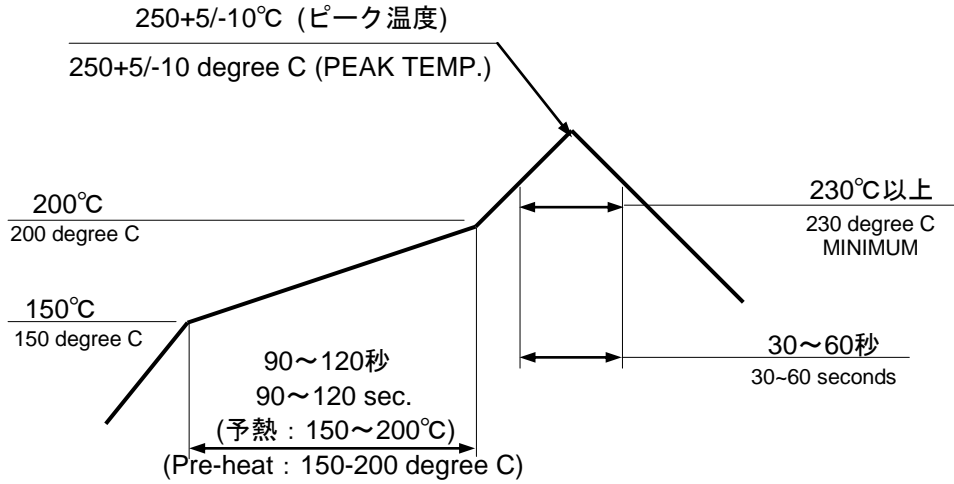

温度条件グラフ
TEMPERATURE CONDITION GRAPH

半田接合部の基板表面にて測定

(Temperature is measured at the soldering area on the surface of the print writing board)

注記 : 本リフロー条件に関しては、温度プロファイル、半田ペースト、大気、N₂リフロー、基板などにより条件が異なりますので事前に実装評価(リフロー評価)を必ず実施願います。実装条件によっては、製品性能に影響を及ぼす場合があります。

NOTE: Please investigate the mounting condition (reflow soldering condition) on your own devices beforehand. The mounting conditions may change due to the soldering temperature, soldering paste, air reflow machine, Nitrogen reflow machine, and the type of printed writing board. The different mounting conditions may have an influence on the product's performance.

REVISE ON PC ONLY		TITLE:	
E	SEE SHEET 1 OF 21	0.5 mm PITCH FFC TO BOARD CONNECTOR	
		製品仕様書	
REV.	DESCRIPTION	THIS DOCUMENT CONTAINS INFORMATION THAT IS PROPRIETARY TO MOLEX ELECTRONIC TECHNOLOGIES, LLC AND SHOULD NOT BE USED WITHOUT WRITTEN PERMISSION	
DOCUMENT NUMBER PS-501786-001		FILE NAME PS501786001.docx	SHEET 8 OF 21
EN-037(2015-11 rev.1)			

【 8. 使用上の注意事項 INSTRUCTION UPON USAGE】

8-1. 各部の名称

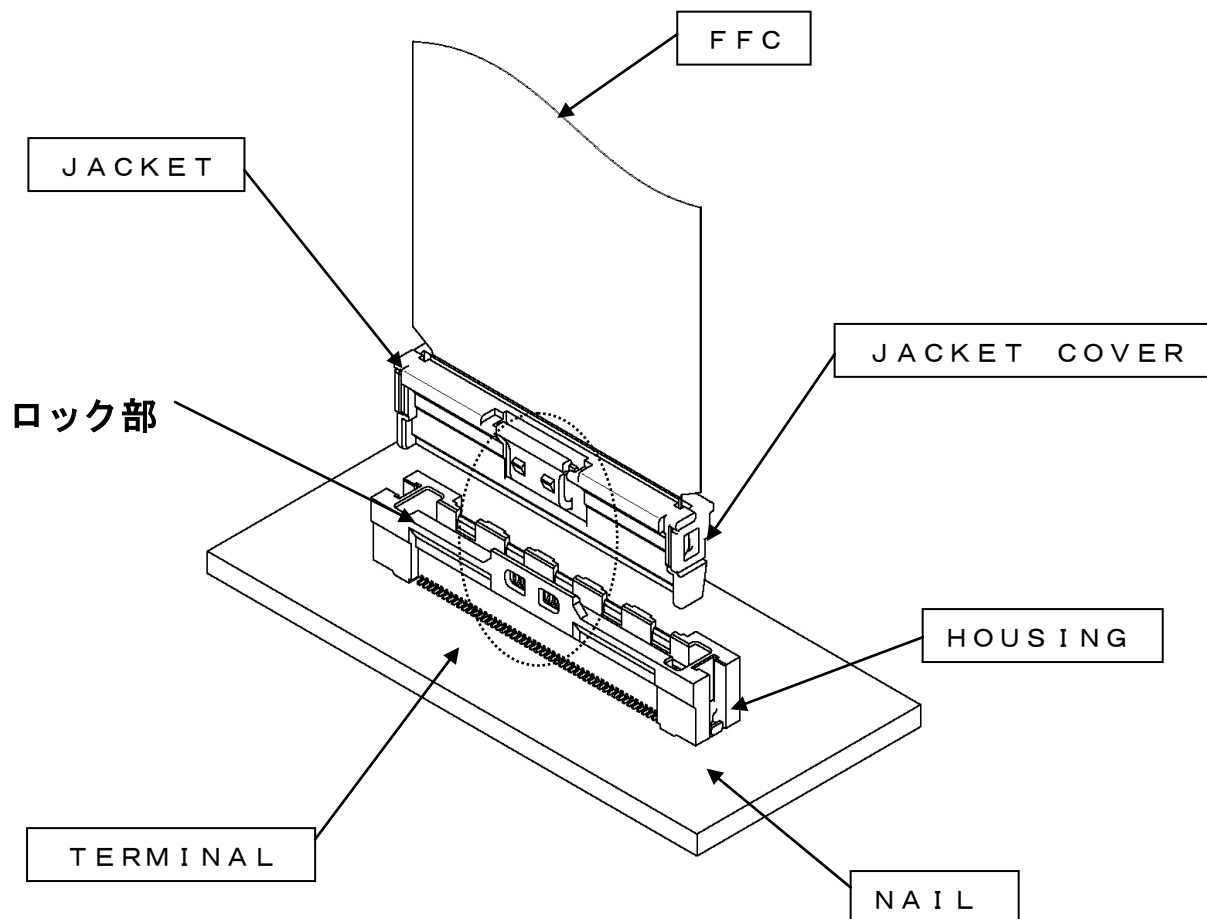

REVISE ON PC ONLY		TITLE: 0.5 mm PITCH FFC TO BOARD CONNECTOR	
E	SEE SHEET 1 OF 21	製品仕様書	
REV.	DESCRIPTION	THIS DOCUMENT CONTAINS INFORMATION THAT IS PROPRIETARY TO MOLEX ELECTRONIC TECHNOLOGIES, LLC AND SHOULD NOT BE USED WITHOUT WRITTEN PERMISSION	
DOCUMENT NUMBER PS-501786-001		FILE NAME PS501786001.docx	SHEET 9 OF 21
EN-037(2015-11 rev.1)			

8-2. 外観について

- 8-2-1. 本製品の樹脂部に黒点、多少の傷、微小な気泡等が生じることがありますが、性能上問題ありません。また、本製品のモールド材料は LCP を使用しているため、ウェルドラインが目立つ場合がありますが、製品性能には影響ないものです。
Although this product may have a small black dot, a weld line or a scratch on the housing, it doesn't impact the product's performance. Also, although weld line may stand out due to LCP used to mold material of this product, it doesn't impact the product's performance.
- 8-2-2. 成形品の色相に多少の違いを生じる場合がありますが、製品性能には影響ありません。
Although there may be slight differences in the housing color tone, it doesn't impact the product's performance.
- 8-2-3. 本製品の錫めっきを使用しているため、外観に摺動痕がつく場合が御座いますが、製品性能に影響はありません。
Although the surface of the product could have scratch marks by frictions because of the Tin plating, it doesn't impact the product's performance.

8-3. 実装について

- 8-3-1. 本製品の一般性能確認はリジッド基板にて実施しております。フレキシブル基板等の特殊な基板へ実装する場合は、事前に実装確認等を行った上でご使用願います。
The product performance was tested using rigid PWB. In case the product needs to be mounted onto FPC, please conduct a reflow test on the FPC before use.
- 8-3-2. フレキシブル基板に実装する場合は、基板の変形を防止するため、補強板をご使用願います。
In case of mounting the connector onto FPC, add a stiffener on the FPC in order to prevent the deformation.
- 8-3-3. 本コネクタを搭載する基板(PWB/FPC)において、過度な温度上昇を避ける為、適切なパターンデザインを行ってください。
Please design appropriate pattern on boards (PWB / FPC) for this connector to avoid excess temperature rise.
- 8-3-4. 弊社の推奨基板パターン寸法を変更して設計を行なう際は、致命的な不良の原因にもなりますので、あらかじめご相談ください。
In case of designing with changing our recommended board pattern size, please consult the contact person in advance because it may cause a fatal defect.
- 8-3-5. 実装性能(平坦度)は、実装基板の反りの影響を含まないものと致します。基板の反りはコネクタ両端部を基準とし、コネクタ中央部にて Max0.02mm として下さい。
The mounting specification for coplanarity does not include the influence of warpage of the PWB. Warpage of the PWB should be 0.02mm at maximum at center of the connector based on the both sides of connector.

REVISE ON PC ONLY		TITLE: 0.5 mm PITCH FFC TO BOARD CONNECTOR 製品仕様書	THIS DOCUMENT CONTAINS INFORMATION THAT IS PROPRIETARY TO MOLEX ELECTRONIC TECHNOLOGIES, LLC AND SHOULD NOT BE USED WITHOUT WRITTEN PERMISSION	
E	SEE SHEET 1 OF 21			
REV.	DESCRIPTION			
DOCUMENT NUMBER PS-501786-001		FILE NAME PS501786001.docx	SHEET 10 OF 21	
EN-037(2015-11 rev.1)				

- 8-3-6. 本製品は大気リフローでの実装を想定しています。N2 リフローで実装した場合、リフロー後、半田上がりを生じる恐れがあります。N2 リフローでの実装をお考えの場合、別途評価が必要になります。
This product is designed to be mounted by air reflow. So, if this product is mounted by N2 reflow, solder wicking may be caused after reflow. Therefore if it is plan to adopt N2 reflow for this connector, an evaluation is needed separately.
- 8-3-7. 弊社評価では本仕様書記載の推奨条件に基づき評価を実施しています。
Our evaluation is conducted based on Molex-recommended condition specified in this product specification.
- 8-3-8. 本製品の平坦度については、実装前での保証のみであり、実装中および実装後での平坦度については、保証の限りではありません。
Only coplanarity before reflow is guaranteed. Coplanarity in and after reflow is not guaranteed.
- 8-3-9. 半田実装部の未半田は、ターミナル脱落、ピン間ショート、ターミナル座屈、またコネクタの基板からの外れが懸念されます。従って全てのターミナルテール部及び、ネイル部に半田付けを行って下さい。
If you leave any soldering area on this product open, it could occur terminal disengagement, short circuit between pins, terminal buckling or connector disengagement from the PWB. Therefore, please solder all of the soldering tails and fitting nails on the PWB.
- 8-3-10. 実装機によってコネクタに負荷が加わると変形、破損する場合がありますので事前にご確認下さい。
If accidental contact is added onto connectors in the reflow machine, connectors could be deformed or damaged. Therefore review the reflow machine before use of the connectors.
- 8-3-11. リフロー条件によっては、樹脂部の変色が発生する場合がありますが、製品性能に影響はございません。
Although color tone of housing could be varied depending on reflow conditions, it does not impact on the product's performance.
- 8-3-12. リフロー後、半田付け部に変色が見られることがありますが、製品性能に影響はありません。
Although some discoloration could be seen on the soldering tail after reflow, it does not impact on the product's performance.
- 8-3-13 基板への実装は実装機にて実施願います。もし、手半田する場合は、ターミナル及びネイル等に触れない様に願います。(半田付け不良等の原因となる可能性が有ります。)
The mounting of the PC board is handled by the mounter. If to manually solder, please be cautious to not touch the Terminal and Fitting Nail.(It will create the possibility to cause solderability failure.)

REVISE ON PC ONLY		TITLE: 0.5 mm PITCH FFC TO BOARD CONNECTOR 製品仕様書	THIS DOCUMENT CONTAINS INFORMATION THAT IS PROPRIETARY TO MOLEX ELECTRONIC TECHNOLOGIES, LLC AND SHOULD NOT BE USED WITHOUT WRITTEN PERMISSION	
E	SEE SHEET 1 OF 21			
REV.	DESCRIPTION			
DOCUMENT NUMBER PS-501786-001		FILE NAME PS501786001.docx	SHEET 11 OF 21	
EN-037(2015-11 rev.1)				

8-4. コネクタ嵌合に関して

コネクタを嵌合する際は、JACKETとJACKET COVERの全体もしくは中央を掴んで挿入を実施ください。

When mating the connector, hold the JACKET AND JACKET COVER together at either a whole or the center portion of them to insert.

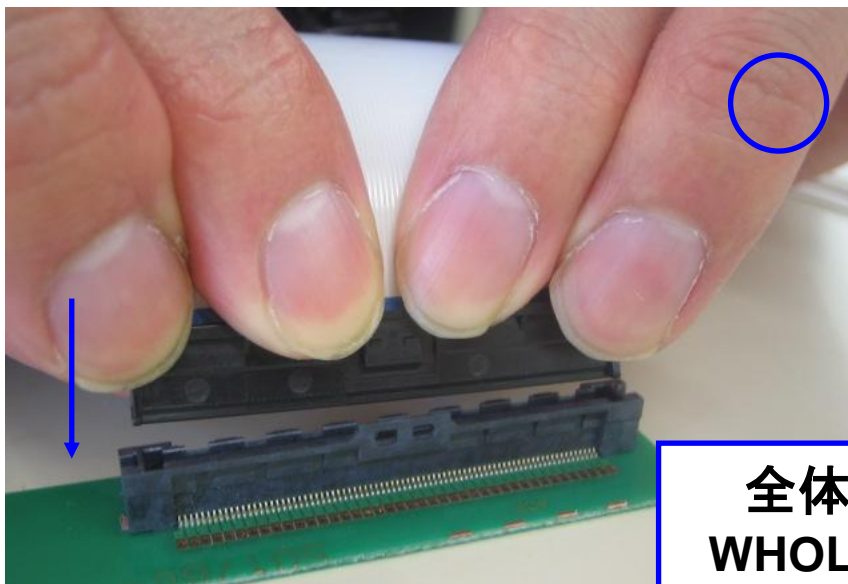

**全体
WHOLE**

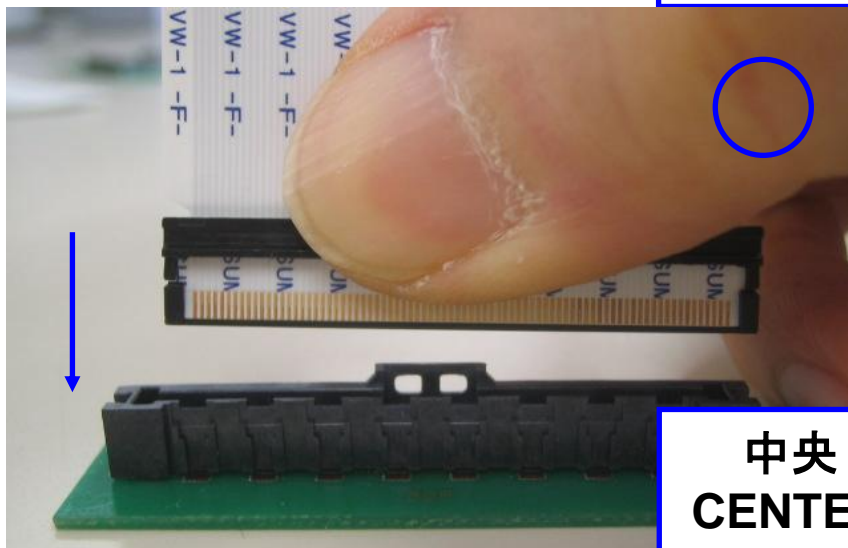

**中央
CENTER**

E	REVISE ON PC ONLY	TITLE: 0.5 mm PITCH FFC TO BOARD CONNECTOR 製品仕様書
	SEE SHEET 1 OF 21	
REV.	DESCRIPTION	THIS DOCUMENT CONTAINS INFORMATION THAT IS PROPRIETARY TO MOLEX ELECTRONIC TECHNOLOGIES, LLC AND SHOULD NOT BE USED WITHOUT WRITTEN PERMISSION
DOCUMENT NUMBER PS-501786-001		FILE NAME PS501786001.docx
		SHEET 12 OF 21
EN-037(2015-11 rev.1)		

以下のような嵌合は回復不可能な機能不全や製品破壊につながりますので実施しないで下さい。
The following method of mating will cause either irreversable functionality failure or product breaking, so please do not mate this way.

- ・ F F Cのみを掴まないでください。
Please do not hold the FFC part only

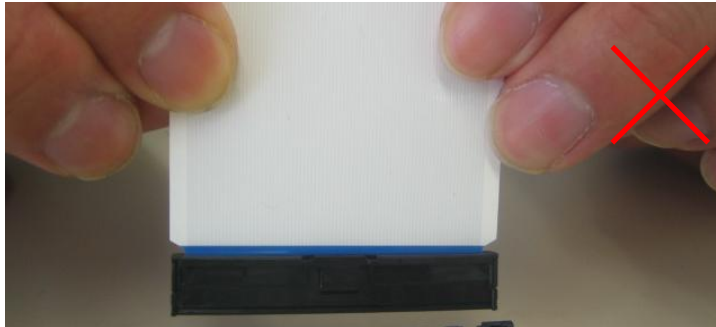

- ・ J A C K E T と J A C K E T C O V E R の 端部のみを掴まないでください。
Please do not hold the JACKET AND edge of the JACKET COVER only



E	REVISE ON PC ONLY	TITLE: 0.5 mm PITCH FFC TO BOARD CONNECTOR 製品仕様書	THIS DOCUMENT CONTAINS INFORMATION THAT IS PROPRIETARY TO MOLEX ELECTRONIC TECHNOLOGIES, LLC AND SHOULD NOT BE USED WITHOUT WRITTEN PERMISSION
	SEE SHEET 1 OF 21		
REV.	DESCRIPTION		
DOCUMENT NUMBER PS-501786-001		FILE NAME PS501786001.docx	SHEET 13 OF 21
EN-037(2015-11 rev.1)			

- ・ FFCを折り曲げるように掴まないでください。
Please do not hold the FFC like bending it.

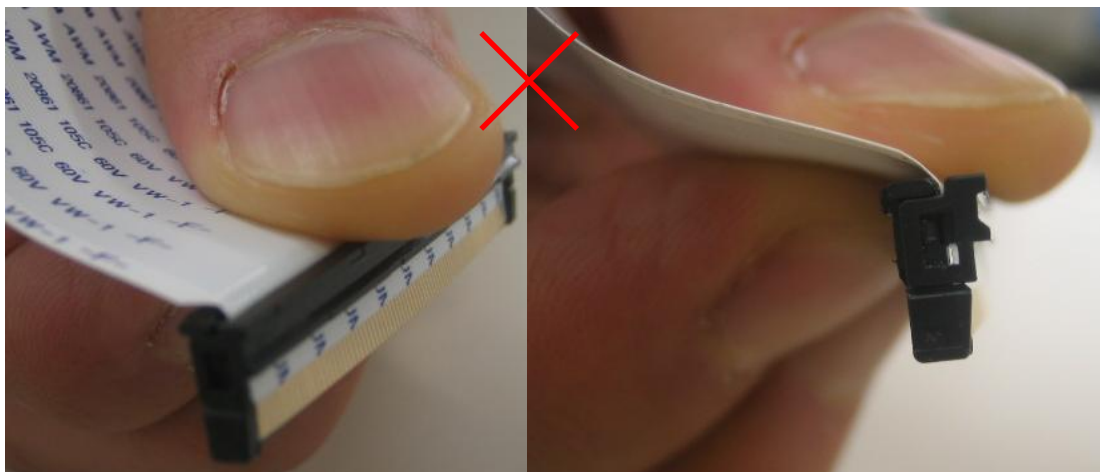

E	REVISE ON PC ONLY	SEE SHEET 1 OF 21	TITLE: 0.5 mm PITCH FFC TO BOARD CONNECTOR	
	REV.		DESCRIPTION	製品仕様書
DOCUMENT NUMBER PS-501786-001			FILE NAME PS501786001.docx	SHEET 14 OF 21
EN-037(2015-11 rev.1)				

- ※ FFCが極端に浮くと、嵌合時にHOUSINGと干渉し座屈する可能性があります。
- ※ If FFC warps too much, it will touch with the Header housing when mated, and may possibly cause buckling.

**FFCの極端な浮き
TO WARPED FFC**

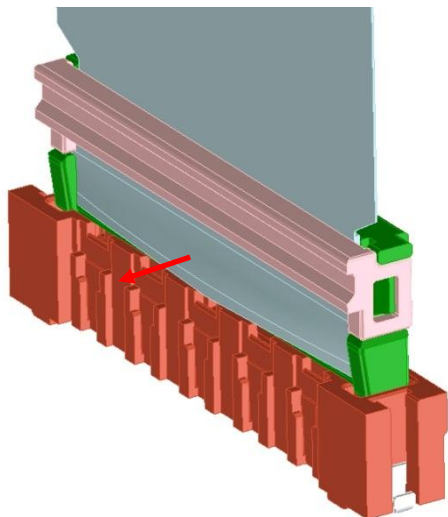

**干渉
TOUCH**

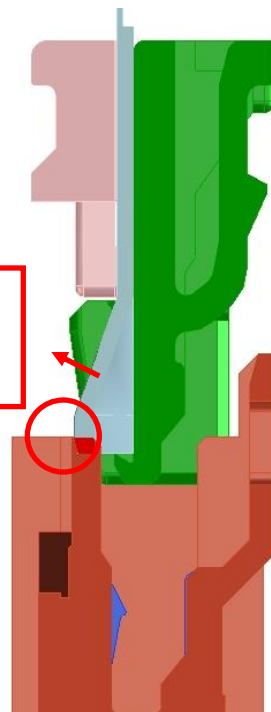

- ・ JACKETとJACKET COVERの片端のみを掴まないでください。斜め嵌合となり、不良につながります。
Please do not hold one side of the JACKET and the JACKET COVER only as shown below. It will be mated in the slant direction and will cause failure

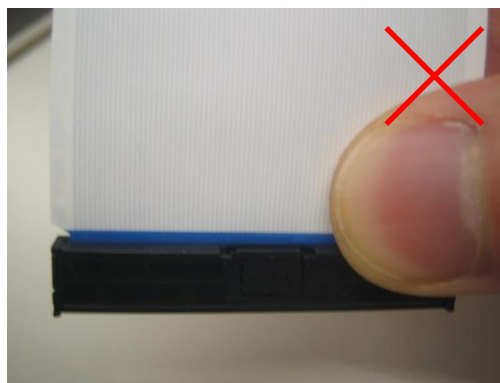

- ・ 斜め嵌合は不良につながりますので実施しないでください。

REVISE ON PC ONLY		TITLE: 0.5 mm PITCH FFC TO BOARD CONNECTOR	
E	SEE SHEET 1 OF 21	製品仕様書	
REV.	DESCRIPTION	THIS DOCUMENT CONTAINS INFORMATION THAT IS PROPRIETARY TO MOLEX ELECTRONIC TECHNOLOGIES, LLC AND SHOULD NOT BE USED WITHOUT WRITTEN PERMISSION	
DOCUMENT NUMBER PS-501786-001		FILE NAME PS501786001.docx	SHEET 15 OF 21
EN-037(2015-11 rev.1)			

Mating inconsistently will cause failure, so please do not do this.

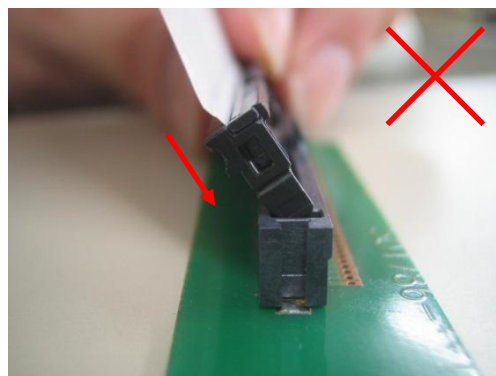
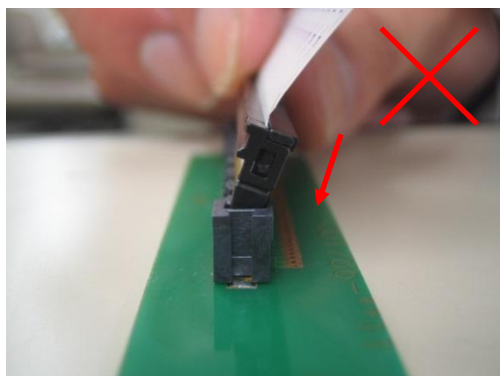
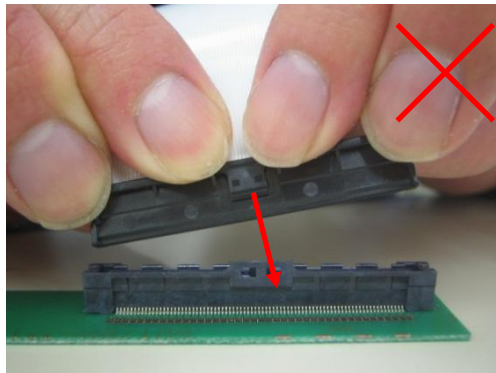
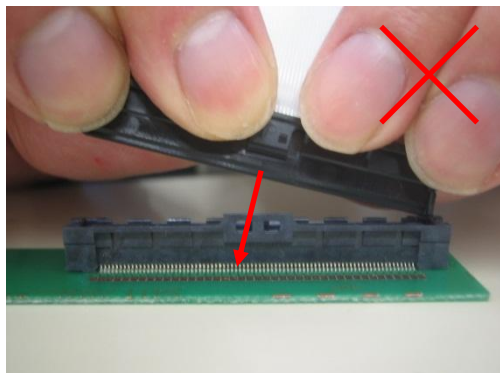

- ・ 嵌合状態 及び 嵌合時の F F C 引き回し作業においてロック部に無理な負荷が掛かるような使用は避けてください。
Please be cautious not to put excess load at the lock part after mating and when FFC is pulled and extracted.

REVISE ON PC ONLY		TITLE:	
E	SEE SHEET 1 OF 21	0.5 mm PITCH FFC TO BOARD CONNECTOR	
		製品仕様書	
REV.	DESCRIPTION	THIS DOCUMENT CONTAINS INFORMATION THAT IS PROPRIETARY TO MOLEX ELECTRONIC TECHNOLOGIES, LLC AND SHOULD NOT BE USED WITHOUT WRITTEN PERMISSION	
DOCUMENT NUMBER PS-501786-001		FILE NAME PS501786001.docx	SHEET 16 OF 21
EN-037(2015-11 rev.1)			

- ③ コネクタの嵌合を取り外す際は、必ずロック解除して実施ください。
Please be sure to release the lock when unmating the connector.

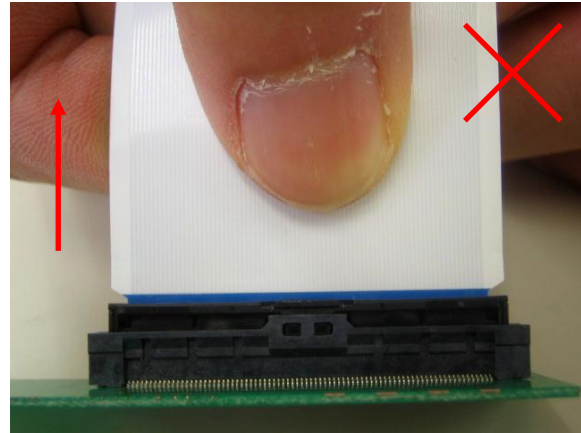
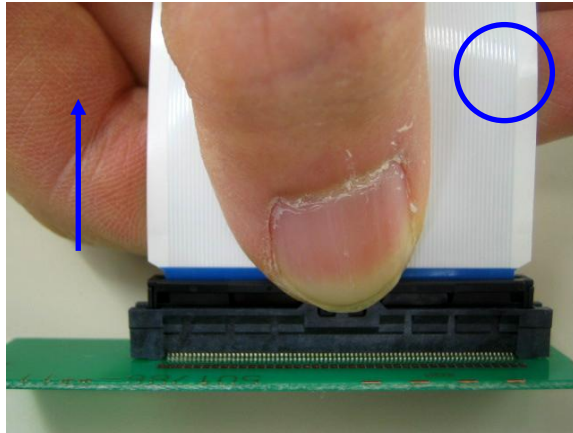

8-5. ご使用のFFCに関して

御社でのFFC選定時には以下を必ずご確認ください、実機での評価/可否判断をお願いします。
高温環境での不具合回避にはFPCの使用をご検討ください。

When actually using it with connector, please do the evaluation and the confirmation with an actual equipment to evade the following case where reliability cannot be filled.

Because an FPC resists heat than FFC; in some cases use the FPC.(high-temperature environment case etc)

FFCに規定された定格温度がFFC単体前提の場合が御座います。

この場合、コネクタと組み合わせての実使用において、高温環境でFFC基材と導体間の接着層が劣化し接着力が低下、その後の温度変動によるコネクタ/FFCの収縮により、導体自体のピッチ方向ズレが発生し、長期的には接点脱落、不導通に至る事例が確認されております。

The adhesive line of FFC is deteriorated by high temperature heat.

Then contact conductor of FFC may move.

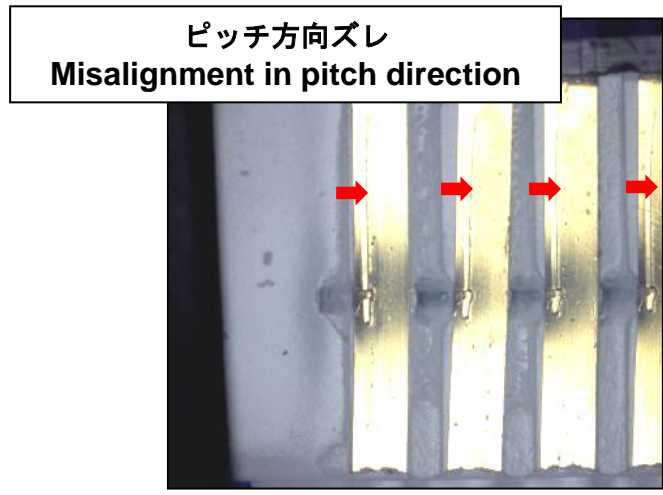

E	REVISE ON PC ONLY	TITLE: 0.5 mm PITCH FFC TO BOARD CONNECTOR 製品仕様書	THIS DOCUMENT CONTAINS INFORMATION THAT IS PROPRIETARY TO MOLEX ELECTRONIC TECHNOLOGIES, LLC AND SHOULD NOT BE USED WITHOUT WRITTEN PERMISSION
	SEE SHEET 1 OF 21		
REV.	DESCRIPTION		
DOCUMENT NUMBER PS-501786-001		FILE NAME PS501786001.docx	SHEET 17 OF 21
EN-037(2015-11 rev.1)			

また、同様に高温環境で接着層/基材/補強板が軟化してつぶれ、導体部が陥没、基材と導体の境目に段差が発生し、熱サイクルなど温度変動が極端な場合に、初期段階でコネクタ接点が乗り上げて不導通に至る事例も確認されています。

In addition, a pad of FFC is crushed and may become instantaneous interruption and the non-conduction.

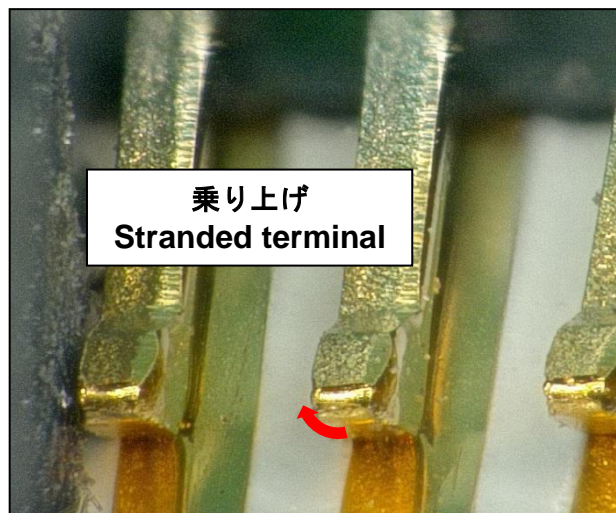
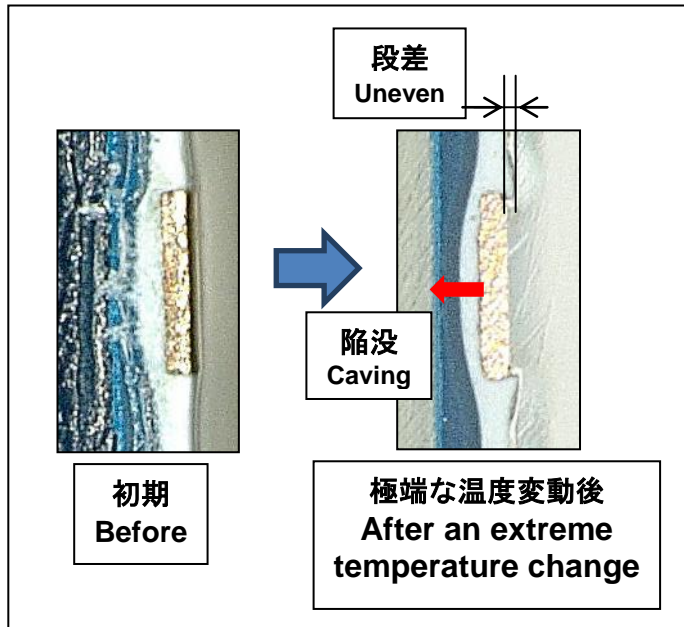

REVISE ON PC ONLY		TITLE: 0.5 mm PITCH FFC TO BOARD CONNECTOR 製品仕様書
E	SEE SHEET 1 OF 21	
REV.	DESCRIPTION	THIS DOCUMENT CONTAINS INFORMATION THAT IS PROPRIETARY TO MOLEX ELECTRONIC TECHNOLOGIES, LLC AND SHOULD NOT BE USED WITHOUT WRITTEN PERMISSION
DOCUMENT NUMBER PS-501786-001		FILE NAME PS501786001.docx
		SHEET 18 OF 21

8-6. 製品の仕様について

- 8-6-1. 本製品をご使用時には、1PIN 当りの定格以上の電流を複数の回路に分岐しての使用は避けて下さい。
When using this product, ensure that the specification for rated current per a circuit is followed. Do not allow the sum of the current used on several circuits to exceed the maximum allowable current.

- 8-6-2. 本製品をご使用時に取り付けられた電線・プリント基板の共振や、機器の回転構造や可動部分の動作によりコネクタ嵌合部(接点部)が常に動いてしまう状態での御使用は避けて下さい。接触部の摺動磨耗等による接触不良の原因となります。従って、機器内で電線・プリント基板を固定し、共振を抑える等の処置をお願い致します。
Do not use the connector in a condition where the mating area (contact area) are constantly moved due to sympathetic vibration of wires and PWB or constant movement of devices. It may cause contact failure due to the worn out. Therefore fix wires and PWB on the chassis to reduces sympathetic vibration.

- 8-6-3. コネクタにFFCを装着した状態で、FFCに過度の負荷が加わらないようにご注意頂き、御社基板のスペース上、コネクタに負担の掛かる位置への取り付けはしないで下さい。FFCの抜け、断線、破損や接触不良の原因となります。特に、連続的に加わる場合はFFCを固定するようにして下さい。また、基板に対して垂直上下方向の引張荷重、コンタクトピッチ方向のこじり荷重を与えない様にご注意願います。
Pay special attention not to apply any pulling force/tension on the FFC while it is inserted into the connector. Avoid placing the connector where load is applied on the connector on the customer's board. The load could cause breaking of FFC wire, and/or damage of FFC. If the location is where constant load is applied on the FFC, fix the FFC directly on the chassis. Also, avoid applying loads to the connector by pulling FFC vertically or twisting FFC back and force horizontally while it is inserted in the connector.

- 8-6-4. 活電状態の電気回路で、挿入、抜去ができることを前提に作られていません。スパーク等による危険の発生、性能不良につながりますので、活電状態での挿入、抜去はしないで下さい。
Do not mate and un-mate connectors while those are energized since this connector is not designed to allow it. It may cause danger due to sparks and functional failure of the product.

- 8-6-5. 適合するFFCの導体部は、金めっき(ニッケル下地)品を使用願います。
Use the appropriate FFC with the contact area with Gold plating (Nickel under plating).

- 8-6-6. 本製品及び加工工程品(仕掛品)や加工品(ハーネス品)の梱包及び輸送・保管時において、コネクタ間での絡みや衝撃、積み重ね等による負荷が掛からないようにして下さい。変形・破損等による性能不良の原因となります。
At packaging, transportation and storing, avoid applying loads to connectors by handling, interference of connectors or piling-up packages. It could cause functional defect such as connector deformation or breakage.

- 8-6-7. 推奨保管条件での保管をお願い致します。もし、梱包品の推奨保管条件を超えてしまった場合は外観、半田付け性を確認の上ご使用ください。
Store the products under recommended storage condition. If the recommended storage conditions of the packaging is exceeded, check the appearance of the products and solder-wettability before use.

- 8-6-8. 基板実装後に基板を直接積み重ねない様に注意してください。
Do not stack PWB directly after mounting the connector on it.

	REVISE ON PC ONLY	TITLE: 0.5 mm PITCH FFC TO BOARD CONNECTOR
E	SEE SHEET 1 OF 21	製品仕様書
REV.	DESCRIPTION	THIS DOCUMENT CONTAINS INFORMATION THAT IS PROPRIETARY TO MOLEX ELECTRONIC TECHNOLOGIES, LLC AND SHOULD NOT BE USED WITHOUT WRITTEN PERMISSION
DOCUMENT NUMBER PS-501786-001		FILE NAME PS501786001.docx
		SHEET 19 OF 21
EN-037(2015-11 rev.1)		

8-6-9. コネクタの性能を損なう恐れがある為、コネクタの洗浄は、行わないで下さい。
Do not wash connector because it may impact the product's function.

8-7. 操作について

8-7-1. 基板実装前後に端子、補強金具に触らないでください。
Do not touch the terminals and fitting nails of connectors before or after mounting onto the PWB.

8-7-2. 嵌合後、コネクタピッチ方向、スパン方向及び回転方向への負荷がかかるような動作またはセットはしないでください。コネクタ破壊や半田クラックを引き起こします。Avoid move or assembly of connector which could apply loads to the direction of the connector pitch, span or rotation. It may damage the connector and crack the soldering.

8-8. リペアについて

8-8-1. 実装後において半田こてによる手修正を行う際は、必ず仕様書掲載の条件以内で行って下さい。条件を超えて実施した場合、端子の抜け、接点ギャップの変化、モールドの変形、溶融等、破損の原因になります。
When conducting manual repairs using a soldering iron, follow the soldering conditions shown in the product specification. If the conditions in the product specification are not followed, it may cause the terminal disengagement, contact gap change, housing deformation, housing melting, and connector damage.

8-8-2. 半田こてによる手修正を行なう際、過度の半田やフラックスを使用しないで下さい。半田上がりやフラックス上がりにより接触、機能不良に至る場合があります。
When conducting manual repairs using a soldering iron, do not use excess solder and flux than needed. It may cause solder wicking and flux wicking issues, and also eventually cause a contact defect and functional issues.

E	REVISE ON PC ONLY	SEE SHEET 1 OF 21	TITLE: 0.5 mm PITCH FFC TO BOARD CONNECTOR 製品仕様書	
	REV.		DESCRIPTION	THIS DOCUMENT CONTAINS INFORMATION THAT IS PROPRIETARY TO MOLEX ELECTRONIC TECHNOLOGIES, LLC AND SHOULD NOT BE USED WITHOUT WRITTEN PERMISSION
DOCUMENT NUMBER PS-501786-001			FILE NAME PS501786001.docx	SHEET 20 OF 21
EN-037(2015-11 rev.1)				

