

LMZ12003 SIMPLE SWITCHER® Power Module Evaluation Module User's Guide



Table of Contents

1 Description.....	1
2 Packaging Highlights.....	1
3 Demo Board Features.....	1
4 Typical Applications.....	2
5 Demo Board Schematic.....	3
6 Demo Board Bill of Materials (BOM).....	4
7 Demo Board Hookup.....	4
8 Demo Board Passive Components.....	5
9 Performance Characteristics.....	6
10 Revision History.....	6

Trademarks

SIMPLE SWITCHER® is a registered trademark of Texas Instruments. All trademarks are the property of their respective owners.

1 Description

The LMZ12003 SIMPLE SWITCHER power module is a complete, easy to use, step-down DC-DC solution capable of driving up to 3-A load. The LMZ12003 is available in an innovative, easy-to-use package that enhances thermal performance and allows for hand or machine soldering.

The LMZ12003 demo board can accept an input voltage rail between 4.5 V and 20 V and deliver an adjustable and highly accurate output voltage as low as 0.8 V. The LMZ12003 only requires three external resistors and four external capacitors to complete the power solution. The LMZ12003 is a reliable and robust solution with the following protection features:

- Thermal shutdown
- Input under-voltage lockout (UVLO)
- Output over-voltage protection (OVP)
- Short-circuit protection
- Output current limit
- Allows start-up into a pre-biased output

A single resistor adjusts switching frequency up to 1 MHz.

2 Packaging Highlights

- 7-lead module package (similar to TO-263)
- Single exposed die attach pad for enhanced thermal performance
- 10.2-mm × 13.8-mm × 4.6-mm module package
- High power density
- 1.7-inch × 2.3-inch reduced size demo board form factor

3 Demo Board Features

- 4.5-V to 20-V power input voltage range
- UVLO programmed at 4.5 V
- 0.8-V to 6-V adjustable output voltage range
- Up to 3-A output current
- Integrated shielded inductor in module
- Efficiency up to 92%

- All ceramic capacitor design
- No loop compensation required
- Starts into pre-biased loads
- Short circuit protection
- Thermal shutdown
- Only nine external passives plus module
- 2-layer low-cost assembly

4 Typical Applications

- Point-of-load conversions from 5-V and 12-V input rails
- Space constrained applications
- Industrial controls
- Telecom
- Networking equipment

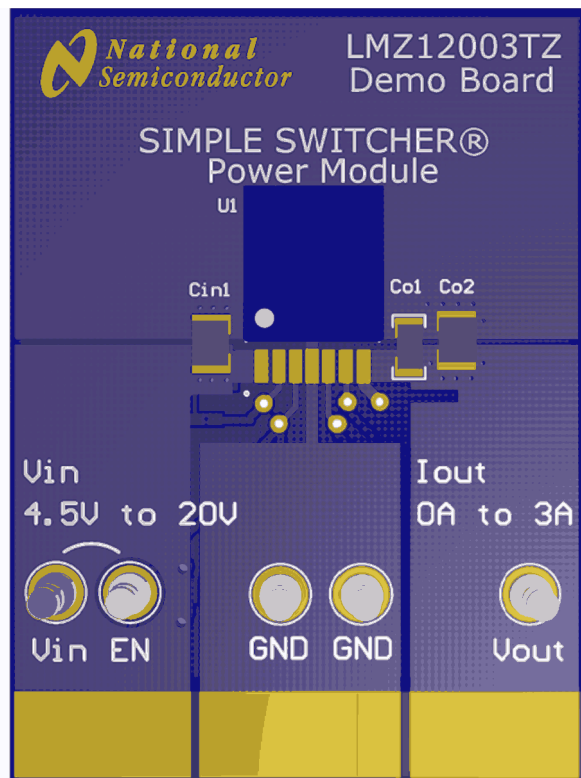

Figure 4-1. Front View

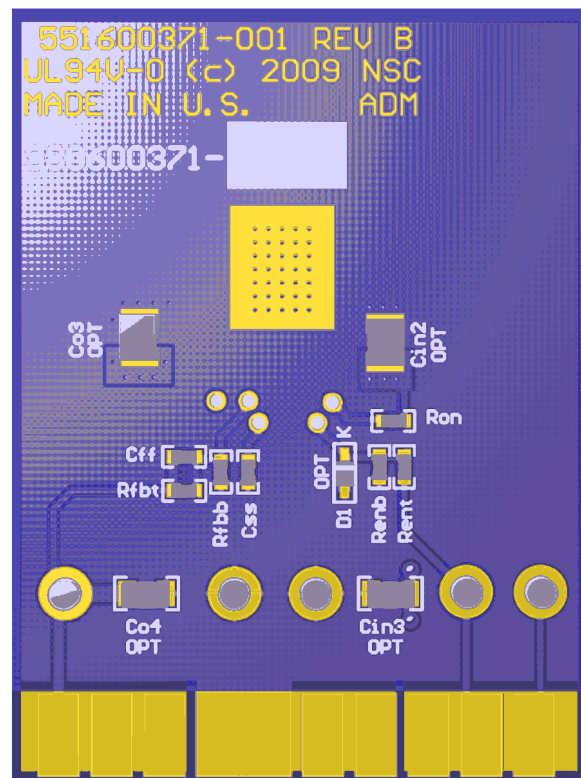

Figure 4-2. Back View

Table 4-1. Absolute Maximum Module Ratings

VIN, RON to GND	-0.3 V to 25 V
EN, FB, SS to GND	-0.3 V to 7 V

Table 4-2. Module Operating Ratings

VIN	4.5 V to 20 V
EN (Input on pin 3 module pin)	0 V to 6.5 V
Junction temperature range (T _J)	-40°C to +125°C

Table 4-3. Demo Board Operating Ratings

VIN	4.5 V to 20 V
VOU (Default setting)	1.8 V
IOU	0 A to 3 A
EN (Input on demo board post)	0 V to 20 V

Table 4-3. Demo Board Operating Ratings (continued)

UVLO setting on Enable input	4.5 V
Soft-start time	2.2 mS
Operating temperature range (T _J)	-40°C to +70°C (at full 3-A load)

5 Demo Board Schematic

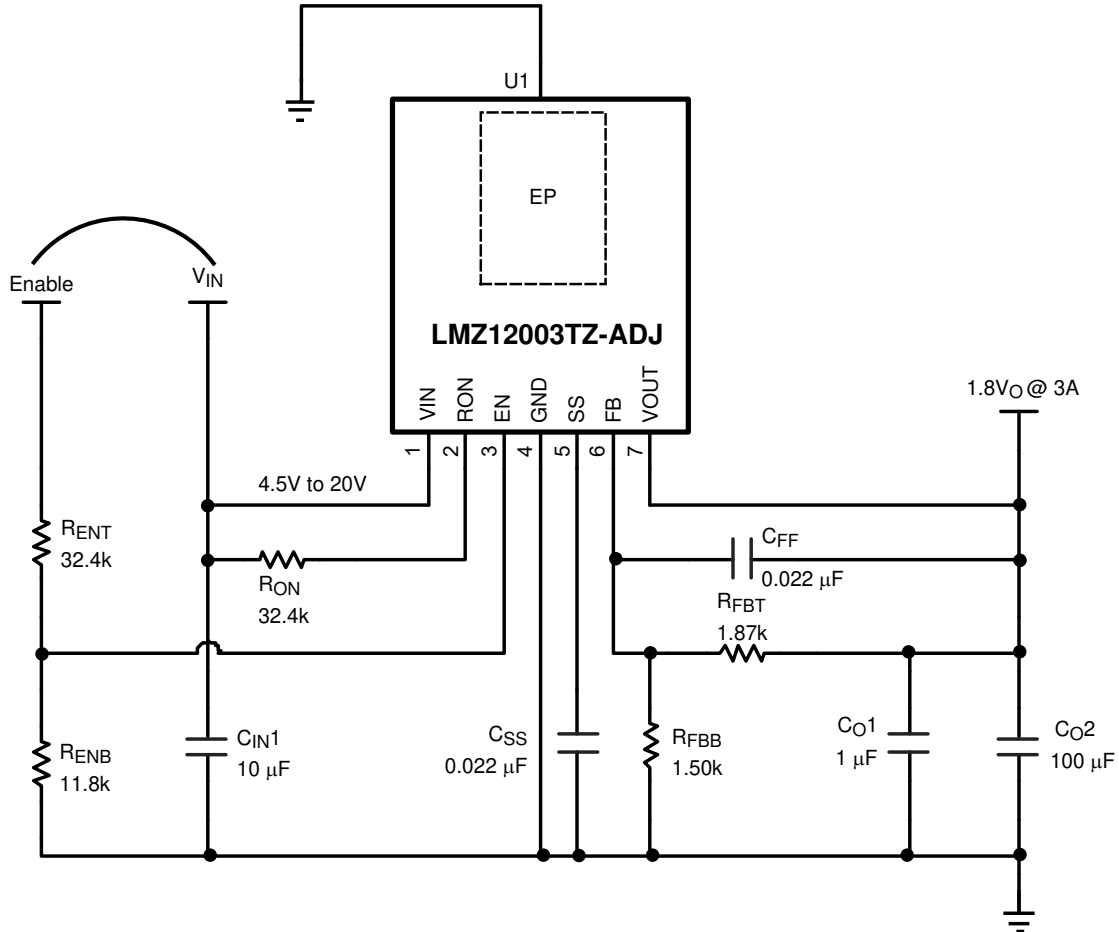

6 Demo Board Bill of Materials (BOM)

Table 6-1. Board Bill of Materials (BOM)

Ref Des	Description	Case	Manufacturer Part Number
Ron	32.4 k Ω 1% resistor	603	
Rent	32.4 k Ω 1% resistor	603	
Renb	11.8 k Ω 1% resistor	603	
Rfbt	1.87 k Ω 1% resistor	603	
Rfbb	1.50 k Ω 1% resistor	603	
Cff	0.022- μ F, 50-V, X7R ceramic capacitor	603	
Css	0.022- μ F, 50-V, X7R ceramic capacitor	603	
Cin	10- μ F, 50-V, X5R ceramic capacitor	1210	UMK325BJ106MM-T
Cout1	1.0- μ F, 50-V, X7R ceramic capacitor	1206	UMK316B7105KL-T
Cout2	100- μ F, 6.3-V, X5R ceramic capacitor	1210	JMK325BJ107MM-T
U1	LMZ12003 SIMPLE SWITCHER Power Module	TO-PMOD	LMZ12003TZ-ADJ
Alternate resistor values for alternative output voltages			
VOUT	RFBT	RFBB	RON
6	2.49 k	383 Ω	124 k
5	5.62 k	1.07 k	100 k
3.3	3.32 k	1.07 k	61.9 k
2.5	2.26 k	1.07 k	47.5 k
1.8	1.87 k	1.50 k	32.4 k
1.5	1.00 k	1.13 k	28.0 k
1.2	4.22 k	8.45 k	22.6 k
0.8	0.0 K	39.2 k	24.9 k

7 Demo Board Hookup

VOUT: Connect the load to V_{OUT} and one of the GND posts. The module can source up to a 3-A load current.

Connect V_{IN} to a positive voltage in the 4.5-V to 20-V range. Connect the negative terminal of the source supply to one of the posts labeled GND.

The Enable input post is configured for direct connection to the V_{IN} post. With the chosen resistor values, this results in an undervoltage lockout level of 4.5-V input. The top enable resistor is RENT (aka REN1) and the bottom enable resistor is RENB (aka REN2).

If the Enable post is disconnected, the module will be disabled and about 20 μ A of supply current will flow from V_{IN} to ground while in the disabled mode. With the enable input connected to V_{IN} through the resistor divider, there will be about 1.5 mA of no-load quiescent current into the V_{IN} input. Additional current flows into the enable divider string.

8 Demo Board Passive Components

Soft-start capacitor: The soft-start capacitor controls the rise time of the output voltage when power is first applied and following the clearing of a fault mode.

Feedback divider: Regulator output voltage is programmed through the selection of the two resistors, RFBT (aka RFB1) and RFB (aka RFB2). A feedforward capacitor (CFF) is located in parallel with the upper feedback divider resistor. This capacitor improves the step response to abrupt changes in load current. For a different output voltage, see [Table 6-1](#) when modifying the board. Resistor values shown will minimize error in output voltage setting.

RON Resistor: The primary function of the RON resistor is to set the on-time interval of the internal control section switching cycle. The secondary function of the RON resistor is to create a nearly constant operating frequency over the input operating voltage range. If the output voltage of the regulator is changed by adjusting the feedback divider, then it is generally required that the RON resistor value also be changed in order to maintain the same operating frequency.

Cout: A parallel connection of a 1- μ F, 50-V and a 100- μ F, 6.3-V multilayer ceramic are used for the output capacitor. Locations are provided on the PCB assembly for experimenting with additional output capacitors..

Cin: A 10- μ F, 50-V multilayer ceramic is connected as the input filter. Locations are provided on the PCB assembly for experimenting with additional input capacitors.

9 Performance Characteristics

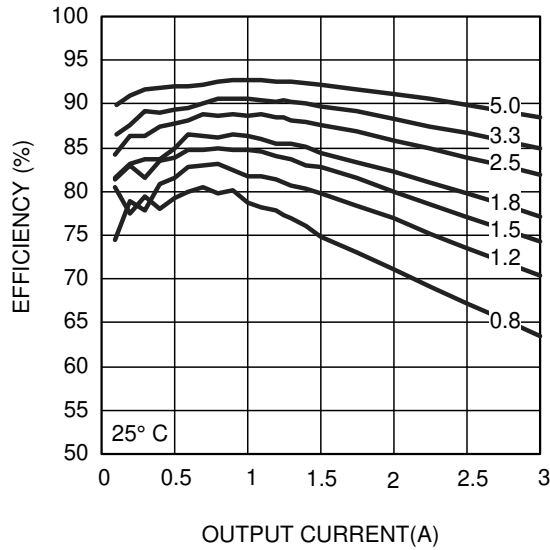

Figure 9-1. Efficiency, 12 V Input at 25°C

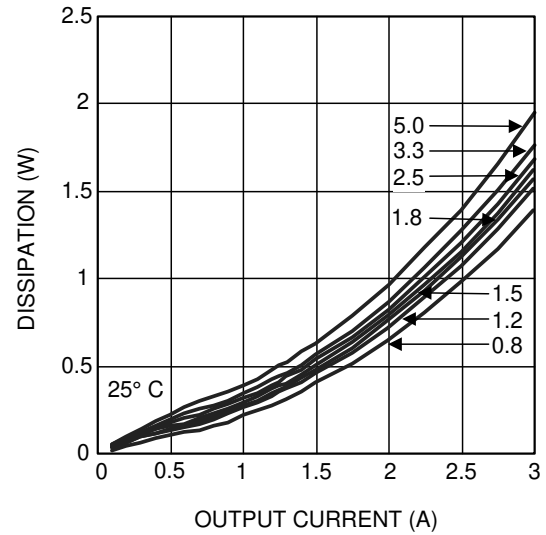

Figure 9-2. Dissipation, 12 V Input at 25°C

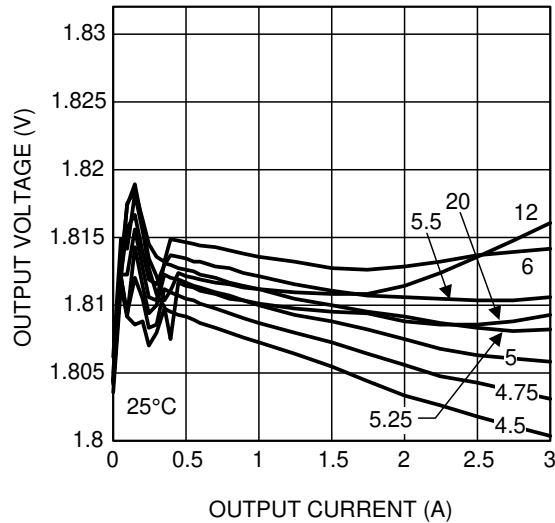

Figure 9-3. Line and Load Regulation at 25°C

10 Revision History

NOTE: Page numbers for previous revisions may differ from page numbers in the current version.

Changes from Revision B (April 2013) to Revision C (December 2021)	Page
• Updated the numbering format for tables, figures, and cross-references throughout the document.....	1
• Updated the user's guide title.....	1
• Edited the user's guide for clarity.....	1

IMPORTANT NOTICE AND DISCLAIMER

TI PROVIDES TECHNICAL AND RELIABILITY DATA (INCLUDING DATA SHEETS), DESIGN RESOURCES (INCLUDING REFERENCE DESIGNS), APPLICATION OR OTHER DESIGN ADVICE, WEB TOOLS, SAFETY INFORMATION, AND OTHER RESOURCES "AS IS" AND WITH ALL FAULTS, AND DISCLAIMS ALL WARRANTIES, EXPRESS AND IMPLIED, INCLUDING WITHOUT LIMITATION ANY IMPLIED WARRANTIES OF MERCHANTABILITY, FITNESS FOR A PARTICULAR PURPOSE OR NON-INFRINGEMENT OF THIRD PARTY INTELLECTUAL PROPERTY RIGHTS.

These resources are intended for skilled developers designing with TI products. You are solely responsible for (1) selecting the appropriate TI products for your application, (2) designing, validating and testing your application, and (3) ensuring your application meets applicable standards, and any other safety, security, regulatory or other requirements.

These resources are subject to change without notice. TI grants you permission to use these resources only for development of an application that uses the TI products described in the resource. Other reproduction and display of these resources is prohibited. No license is granted to any other TI intellectual property right or to any third party intellectual property right. TI disclaims responsibility for, and you will fully indemnify TI and its representatives against, any claims, damages, costs, losses, and liabilities arising out of your use of these resources.

TI's products are provided subject to [TI's Terms of Sale](#) or other applicable terms available either on ti.com or provided in conjunction with such TI products. TI's provision of these resources does not expand or otherwise alter TI's applicable warranties or warranty disclaimers for TI products.

TI objects to and rejects any additional or different terms you may have proposed.

Mailing Address: Texas Instruments, Post Office Box 655303, Dallas, Texas 75265
Copyright © 2021, Texas Instruments Incorporated