

3-Level NPC Inverter Module

NXH600N65L4Q2F2

The NXH600N65L4Q2F2SG/PG is a power module containing a I-type neutral point clamped three-level inverter. The integrated field stop trench IGBTs and FRDs provide lower conduction losses and switching losses, enabling designers to achieve high efficiency and superior reliability.

Features

- Neutral Point Clamped Three-level Inverter Module
- 650 V Field Stop 4 IGBTs
- Low Inductive layout
- Solderable Pins/Press-fit Pins
- Thermistor
- Pb-Free, Halogen Free/BFR Free and RoHS Compliant

Typical Applications

- Solar Inverters
- Uninterruptable Power Supplies Systems
- Energy Storage System

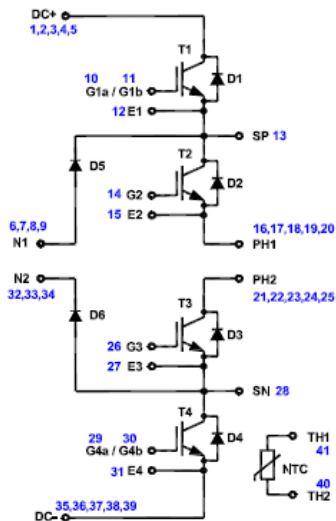
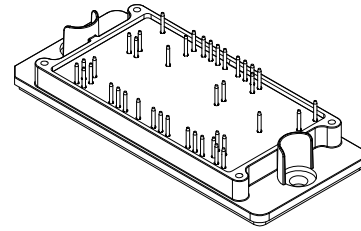
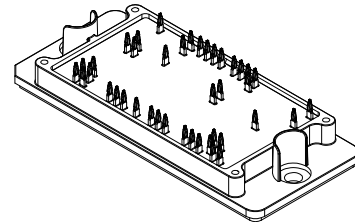

Figure 1. NXH600N65L4Q2F2 Schematic Diagram



PIM41, 93x47 (SOLDER PIN)
CASE 180BC



PIM41, 93x47 (PRESS FIT)
CASE 180HD

MARKING DIAGRAM

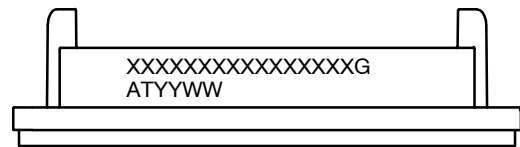

XXXXX = Device Code
G = Pb-Free Package
AT = Assembly & Test Site Code
YYWW = Year and Work Week Code

PIN CONNECTIONS

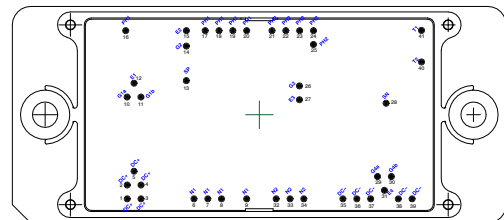

ORDERING INFORMATION

See detailed ordering and shipping information on page 16 of this data sheet.

NXH600N65L4Q2F2

MAXIMUM RATINGS

Parameter	Symbol	Value	Unit
-----------	--------	-------	------

OUTER IGBT (T1, T4)

Collector–Emitter Voltage	V_{CES}	650	V
Gate–Emitter Voltage Positive Transient Gate – Emitter Voltage (tpulse = 5 s, D < 0.10)	V_{GE}	± 20 30	V
Continuous Collector Current @ $T_c = 80\text{ }^\circ\text{C}$ ($T_J = 175\text{ }^\circ\text{C}$)	I_C	483	A
Pulsed Collector Current ($T_J = 175\text{ }^\circ\text{C}$)	I_{Cpulse}	1449	A
Maximum Power Dissipation ($T_J = 175\text{ }^\circ\text{C}$)	P_{tot}	931	W
Minimum Operating Junction Temperature	T_{JMIN}	–40	°C
Maximum Operating Junction Temperature	T_{JMAX}	175	°C

INNER IGBT (T2, T3)

Collector–Emitter Voltage	V_{CES}	650	V
Gate–Emitter Voltage Positive Transient Gate – Emitter Voltage (tpulse = 5 s, D < 0.10)	V_{GE}	± 20 30	V
Continuous Collector Current @ $T_c = 80\text{ }^\circ\text{C}$ ($T_J = 175\text{ }^\circ\text{C}$)	I_C	314	A
Pulsed Collector Current ($T_J = 175\text{ }^\circ\text{C}$)	I_{Cpulse}	942	A
Maximum Power Dissipation ($T_J = 175\text{ }^\circ\text{C}$)	P_{tot}	679	W
Minimum Operating Junction Temperature	T_{JMIN}	–40	°C
Maximum Operating Junction Temperature	T_{JMAX}	175	°C

NEUTRAL POINT DIODE (D5, D6)

Peak Repetitive Reverse Voltage	V_{RRM}	650	V
Continuous Forward Current @ $T_c = 80\text{ }^\circ\text{C}$ ($T_J = 175\text{ }^\circ\text{C}$)	I_F	201	A
Repetitive Peak Forward Current ($T_J = 175\text{ }^\circ\text{C}$)	I_{FRM}	603	A
Maximum Power Dissipation ($T_J = 175\text{ }^\circ\text{C}$)	P_{tot}	477	W
Minimum Operating Junction Temperature	T_{JMIN}	–40	°C
Maximum Operating Junction Temperature	T_{JMAX}	175	°C

INVERSE DIODES (D1, D2, D3, D4)

Peak Repetitive Reverse Voltage	V_{RRM}	650	V
Continuous Forward Current @ $T_c = 80\text{ }^\circ\text{C}$ ($T_J = 175\text{ }^\circ\text{C}$)	I_F	129	A
Repetitive Peak Forward Current ($T_p = 1\text{ ms}$)	I_{FRM}	387	A
Maximum Power Dissipation ($T_J = 175\text{ }^\circ\text{C}$)	P_{tot}	298	W
Minimum Operating Junction Temperature	T_{JMIN}	–40	°C
Maximum Operating Junction Temperature	T_{JMAX}	175	°C

THERMAL PROPERTIES

Storage Temperature Range	T_{stg}	–40 to 150	°C
---------------------------	-----------	------------	----

INSULATION PROPERTIES

Isolation Test Voltage, t = 1 s, 50Hz	V_{is}	4000	V_{RMS}
Creepage Distance		12.7	mm

Stresses exceeding those listed in the Maximum Ratings table may damage the device. If any of these limits are exceeded, device functionality should not be assumed, damage may occur and reliability may be affected.

1. Refer to ELECTRICAL CHARACTERISTICS, RECOMMENDED OPERATING RANGES and/or APPLICATION INFORMATION for Safe Operating parameters.

RECOMMENDED OPERATING CONDITIONS

Parameter	Symbol	Min	Max	Unit
Module Operating Junction Temperature	T_J	–40	175	°C

Functional operation above the stresses listed in the Recommended Operating Ranges is not implied. Extended exposure to stresses beyond the Recommended Operating Ranges limits may affect device reliability.

NXH600N65L4Q2F2

ELECTRICAL CHARACTERISTICS (T_J = 25°C unless otherwise noted)

Parameter	Test Conditions	Symbol	Min	Typ	Max	Unit		
OUTER IGBT (T1, T4)								
Collector-Emitter Cutoff Current	V _{GE} = 0 V, V _{CE} = 650 V	I _{CES}	–	–	100	μA		
Collector-Emitter Saturation Voltage	V _{GE} = 15 V, I _C = 600 A, T _J = 25°C	V _{CE(sat)}	–	1.61	2.2	V		
	V _{GE} = 15 V, I _C = 600 A, T _J = 175°C		–	1.90	–			
Gate-Emitter Threshold Voltage	V _{GE} = V _{CE} , I _C = 2 mA	V _{GE(TH)}	3.1	3.94	5.2	V		
Gate Leakage Current	V _{GE} = 20 V, V _{CE} = 0 V	I _{GES}	–	–	15	μA		
Turn-on Delay Time	T _J = 25°C V _{CE} = 350 V, I _C = 200 A V _{GE} = –9 V to +15 V, R _{Gon} = 15 Ω, R _{Goff} = 23 Ω	t _{d(on)}	–	153.91	–	ns		
Rise Time		t _r	–	45.54	–			
Turn-off Delay Time		t _{d(off)}	–	721.80	–			
Fall Time		t _f	–	10.25	–			
Turn-on Switching Loss per Pulse		E _{on}	–	3.04	–		mJ	
Turn off Switching Loss per Pulse		E _{off}	–	6.58	–			
Turn-on Delay Time		T _J = 125°C V _{CE} = 350 V, I _C = 200 A V _{GE} = –9 V to +15 V, R _{Gon} = 15 Ω, R _{Goff} = 23 Ω	t _{d(on)}	–	139.84		–	ns
Rise Time			t _r	–	49.03		–	
Turn-off Delay Time	t _{d(off)}		–	778.28	–			
Fall Time	t _f		–	31.00	–			
Turn-on Switching Loss per Pulse	E _{on}		–	4.43	–	mJ		
Turn off Switching Loss per Pulse	E _{off}		–	8.18	–			
Input Capacitance	V _{CE} = 20 V, V _{GE} = 0 V, f = 10 kHz		C _{ies}	–	37100	–	pF	
Output Capacitance			C _{oes}	–	1010	–		
Reverse Transfer Capacitance		C _{res}	–	172	–			
Total Gate Charge	V _{CE} = 600 V, I _C = 40 A, V _{GE} = ±15 V	Q _g	–	2180	–	nC		
Thermal Resistance – Chip-to-heatsink	Thermal grease, Thickness = 2 Mil ±2%, λ = 2.87 W/mK	R _{thJH}	–	0.176	–	°C/W		
Thermal Resistance – Chip-to-case		R _{thJC}	–	0.102	–	°C/W		

NEUTRAL POINT DIODE (D5, D6)

Diode Forward Voltage	I _F = 250 A, T _J = 25°C	V _F	–	2.47	3.1	V	
	I _F = 250 A, T _J = 175°C		–	1.91	–		
Reverse Recovery Time	T _J = 25°C V _{CE} = 350 V, I _C = 200 A V _{GE} = –9 V to +15 V, R _G = 15 Ω	t _{rr}	–	19	–	ns	
Reverse Recovery Charge		Q _{rr}	–	480	–	nC	
Peak Reverse Recovery Current		I _{RRM}	–	32.5	–	A	
Peak Rate of Fall of Recovery Current		di/dt	–	3571.45	–	A/μs	
Reverse Recovery Energy		E _{rr}	–	110.56	–	μJ	
Reverse Recovery Time		T _J = 125°C V _{CE} = 350 V, I _C = 200 A V _{GE} = –9 V to +15 V, R _G = 15 Ω	t _{rr}	–	55.62	–	ns
Reverse Recovery Charge			Q _{rr}	–	3801.07	–	nC
Peak Reverse Recovery Current			I _{RRM}	–	108.38	–	A
Peak Rate of Fall of Recovery Current	di/dt		–	3387.11	–	A/μs	
Reverse Recovery Energy	E _{rr}		–	722.83	–	μJ	
Thermal Resistance – Chip-to-heatsink	Thermal grease, Thickness = 2 Mil ±2%, λ = 2.87 W/mK		R _{thJH}	–	0.279	–	°C/W
Thermal Resistance – Chip-to-case		R _{thJC}	–	0.199	–	°C/W	

INNER IGBT (T2,T3)

Collector-Emitter Cutoff Current	V _{GE} = 0 V, V _{CE} = 650 V	I _{CES}	–	–	100	μA
Collector-Emitter Saturation Voltage	V _{GE} = 15 V, I _C = 450 A, T _J = 25°C	V _{CE(sat)}	–	1.59	2.2	V
	V _{GE} = 15 V, I _C = 450 A, T _J = 175°C		–	1.75	–	
Gate-Emitter Threshold Voltage	V _{GE} = V _{CE} , I _C = 1.5 mA	V _{GE(TH)}	3.1	4.02	5.2	V
Gate Leakage Current	V _{GE} = 20 V, V _{CE} = 0 V	I _{GES}	–	–	15	μA

NXH600N65L4Q2F2

ELECTRICAL CHARACTERISTICS (T_J = 25°C unless otherwise noted) (continued)

Parameter	Test Conditions	Symbol	Min	Typ	Max	Unit
INNER IGBT (T2,T3)						
Turn-on Delay Time	T _J = 25°C V _{CE} = 350 V, I _C = 200 A V _{GE} = -9 V to +15 V, R _{Gon} = 15 Ω, R _{Goff} = 21 Ω	t _{d(on)}	-	211.52	-	ns
Rise Time		t _r	-	63.62	-	
Turn-off Delay Time		t _{d(off)}	-	922.97	-	
Fall Time		t _f	-	26	-	
Turn-on Switching Loss per Pulse		E _{on}	-	4.06	-	mJ
Turn off Switching Loss per Pulse		E _{off}	-	5.57	-	
Turn-on Delay Time	T _J = 125°C V _{CE} = 350 V, I _C = 200 A V _{GE} = -9 V to +15 V, R _{Gon} = 15 Ω, R _{Goff} = 21 Ω	t _{d(on)}	-	187.15	-	ns
Rise Time		t _r	-	72.07	-	
Turn-off Delay Time		t _{d(off)}	-	991.52	-	
Fall Time		t _f	-	24.12	-	
Turn-on Switching Loss per Pulse		E _{on}	-	4.84	-	mJ
Turn off Switching Loss per Pulse		E _{off}	-	6.37	-	
Input Capacitance	V _{CE} = 20 V, V _{GE} = 0 V, f = 10 kHz	C _{ies}	-	27600	-	pF
Output Capacitance		C _{oes}	-	814	-	
Reverse Transfer Capacitance		C _{res}	-	131	-	
Total Gate Charge	V _{CE} = 480 V, I _C = 375 A, V _{GE} = ±15 V	Q _g	-	1580	-	nC
Thermal Resistance – Chip-to-heatsink	Thermal grease, Thickness = 2 Mil ±2%, λ = 2.87 W/mK	R _{thJH}	-	0.224	-	°C/W
Thermal Resistance – Chip-to-case		R _{thJC}	-	0.140	-	°C/W

INVERSE DIODES (D1, D2, D3, D4)

Diode Forward Voltage	I _F = 150 A, T _J = 25°C	V _F	-	2.45	3.1	V
	I _F = 150 A, T _J = 175°C		-	1.75	-	
Reverse Recovery Time	T _J = 25°C V _{CE} = 350 V, I _C = 200 A V _{GE} = -9 V to +15 V, R _G = 15 Ω	t _{rr}	-	16.55	-	ns
Reverse Recovery Charge		Q _{rr}	-	178.92	-	nC
Peak Reverse Recovery Current		I _{RRM}	-	16.33	-	A
Peak Rate of Fall of Recovery Current		di/dt	-	2682.93	-	A/μs
Reverse Recovery Energy		E _{rr}	-	33.93	-	μJ
Reverse Recovery Time		T _J = 125°C V _{CE} = 350 V, I _C = 200 A V _{GE} = -9 V to +15 V, R _G = 15 Ω	t _{rr}	-	54.93	-
Reverse Recovery Charge	Q _{rr}		-	2113.76	-	nC
Peak Reverse Recovery Current	I _{RRM}		-	64.50	-	A
Peak Rate of Fall of Recovery Current	di/dt		-	2445.66	-	A/μs
Reverse Recovery Energy	E _{rr}		-	459.95	-	μJ
Thermal Resistance – Chip-to-heatsink	Thermal grease, Thickness = 2 Mil ±2%, λ = 2.87 W/mK		R _{thJH}	-	0.420	-
Thermal Resistance – Chip-to-case		R _{thJC}	-	0.319	-	°C/W

THERMISTOR CHARACTERISTICS

Nominal Resistance	T = 25°C	R ₂₅	-	5	-	kΩ
Nominal Resistance	T = 100°C	R ₁₀₀	-	492.2	-	Ω
Deviation of R25		ΔR/R	-1	-	1	%
Power Dissipation		P _D	-	5	-	mW
Power Dissipation Constant			-	1.3	-	mW/K
B-value	B (25/85), tolerance ±1%		-	3435	-	K

Product parametric performance is indicated in the Electrical Characteristics for the listed test conditions, unless otherwise noted. Product performance may not be indicated by the Electrical Characteristics if operated under different conditions.

NXH600N65L4Q2F2

TYPICAL CHARACTERISTICS – IGBT T1, T4 AND DIODE D5, D6

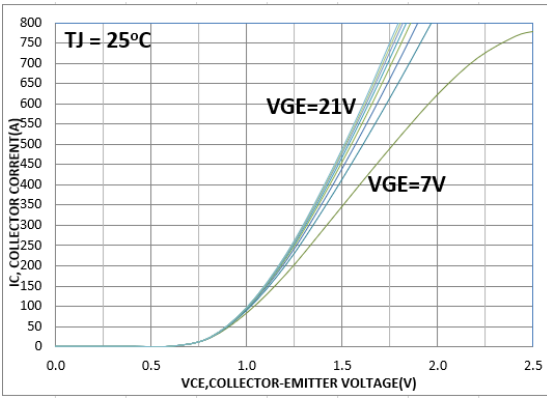

Figure 2. Typical Output Characteristics

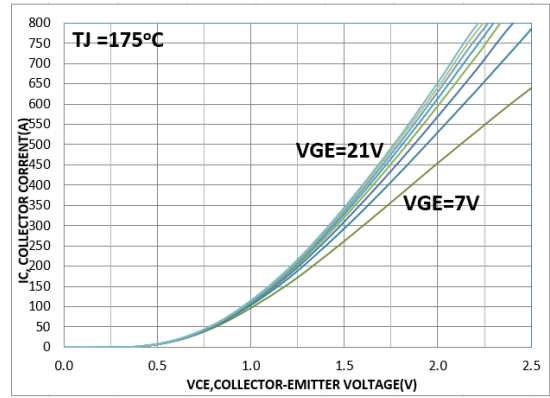

Figure 3. Typical Output Characteristics

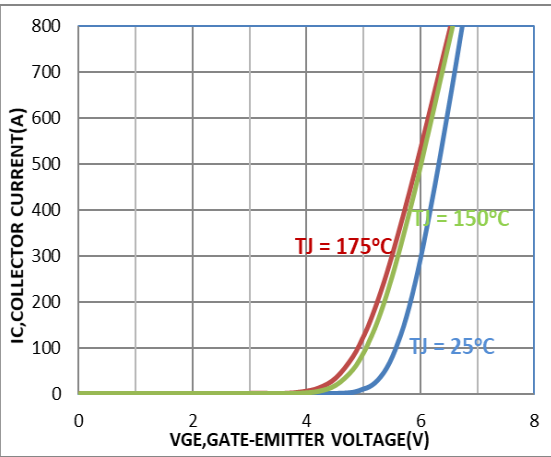

Figure 4. Typical Transfer Characteristics

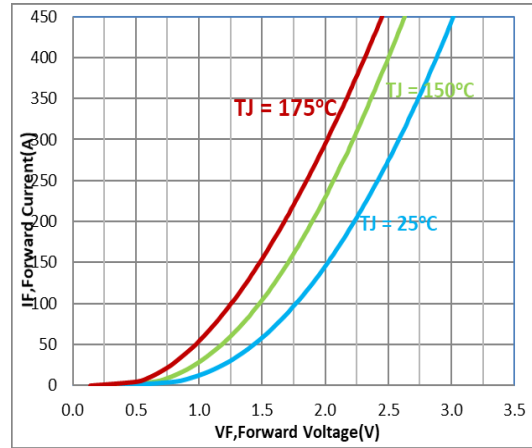

Figure 5. Diode Forward Characteristics

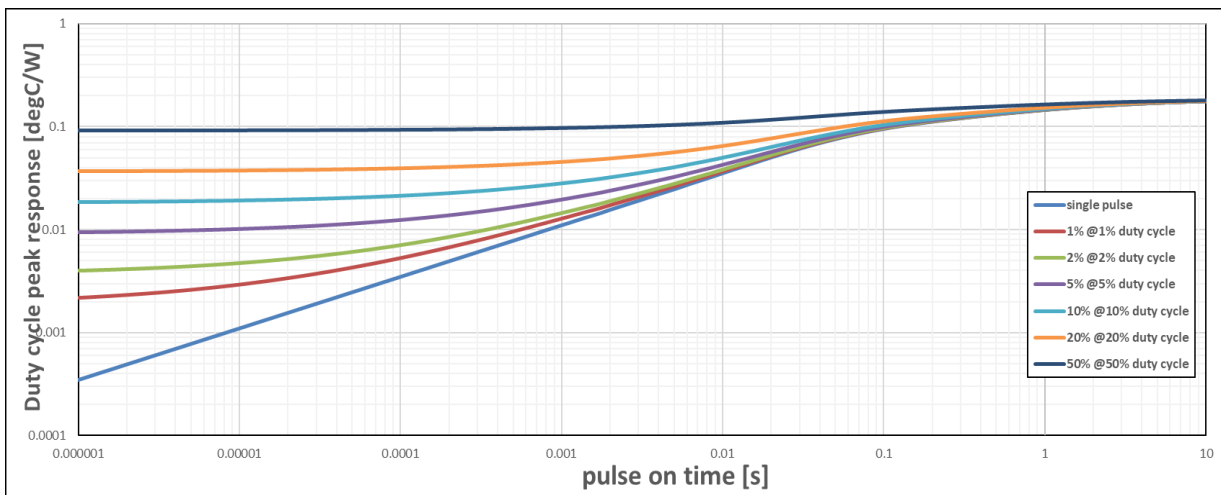

Figure 6. Transient Thermal Impedance (T1, T4)

NXH600N65L4Q2F2

TYPICAL CHARACTERISTICS – IGBT T1, T4 AND DIODE D5, D6 (continued)

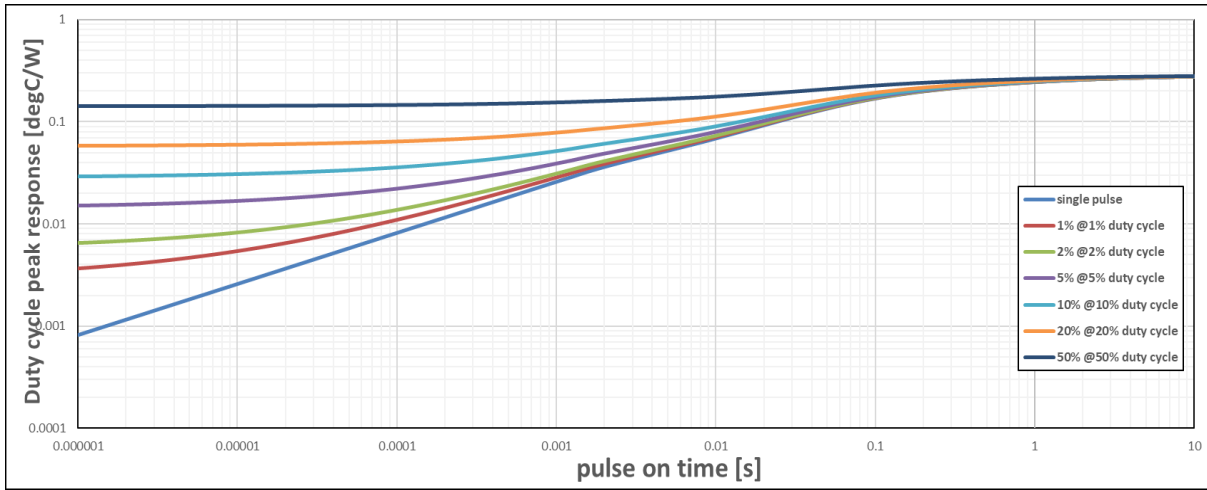

Figure 7. Transient Thermal Impedance (D5, D6)

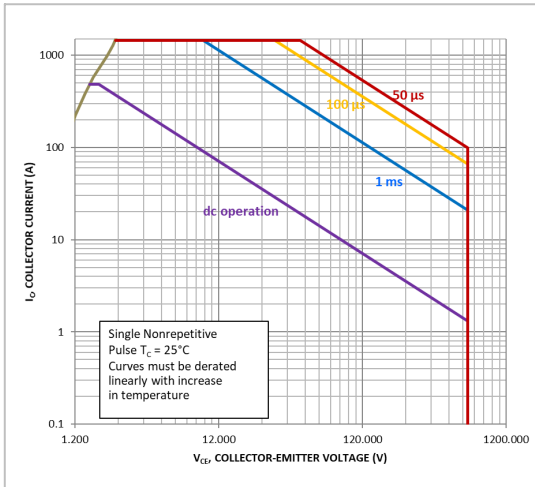

Figure 8. FBSOA (T1, T4)

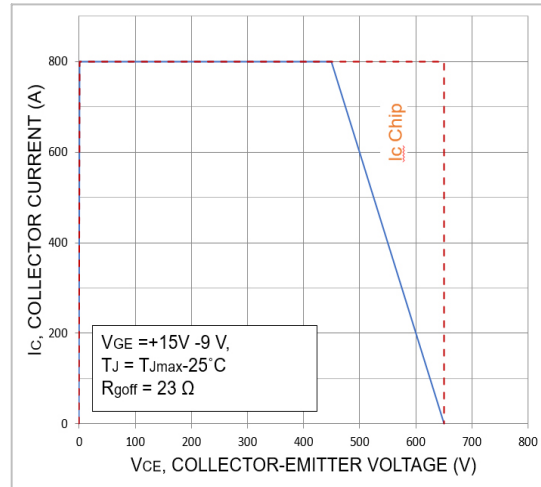

Figure 9. RBSOA (T1, T4)

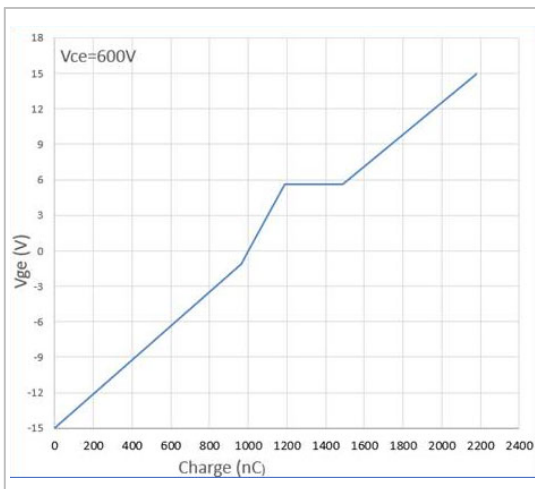

Figure 10. Gate Voltage vs. Gate Charge

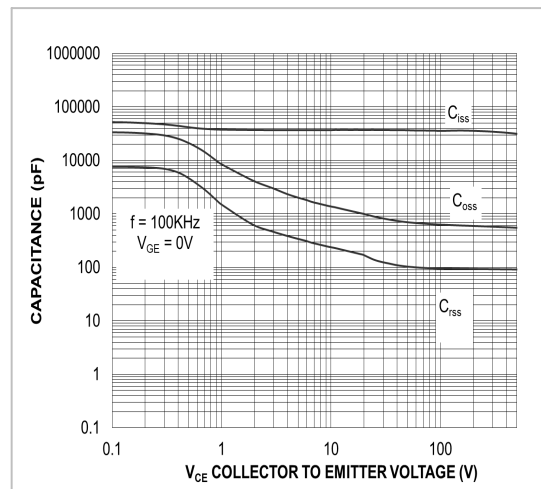

Figure 11. Capacitance

NXH600N65L4Q2F2

TYPICAL CHARACTERISTICS – IGBT T2, T3 AND DIODE D1, D2, D3, D4

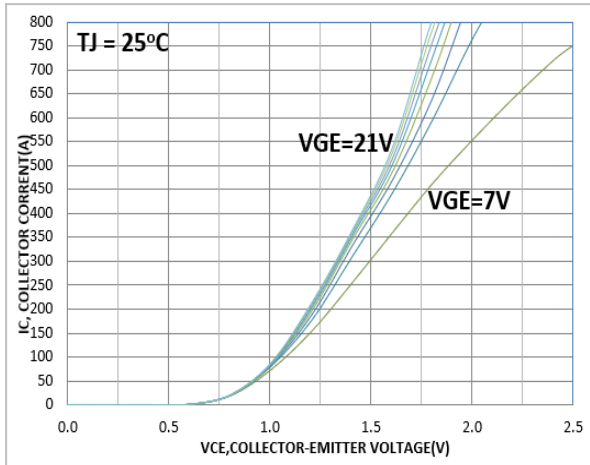

Figure 12. Typical Output Characteristics

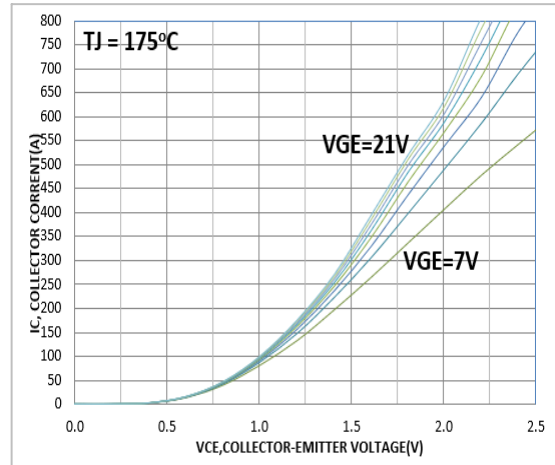

Figure 13. Typical Output Characteristics

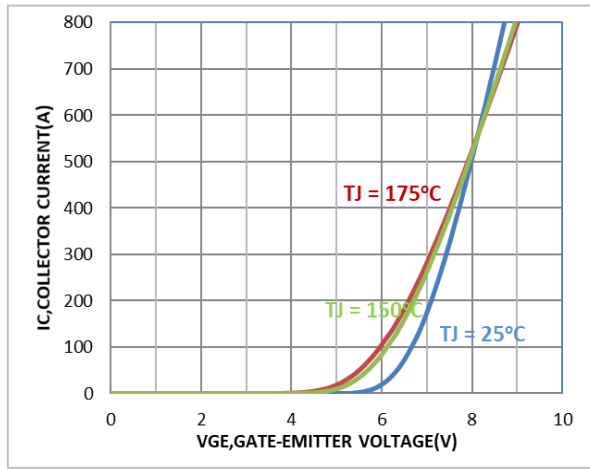

Figure 14. Typical Transfer Characteristics

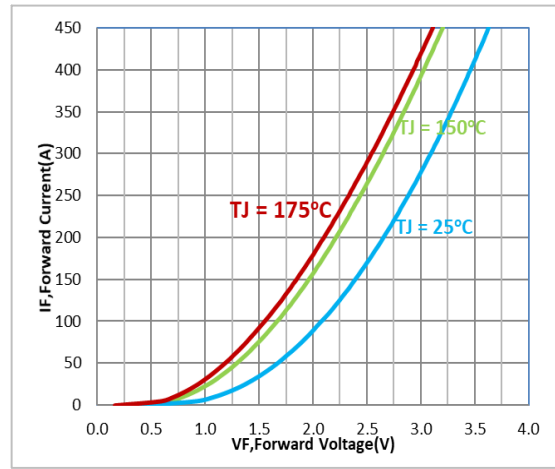

Figure 15. Diode Forward Characteristics

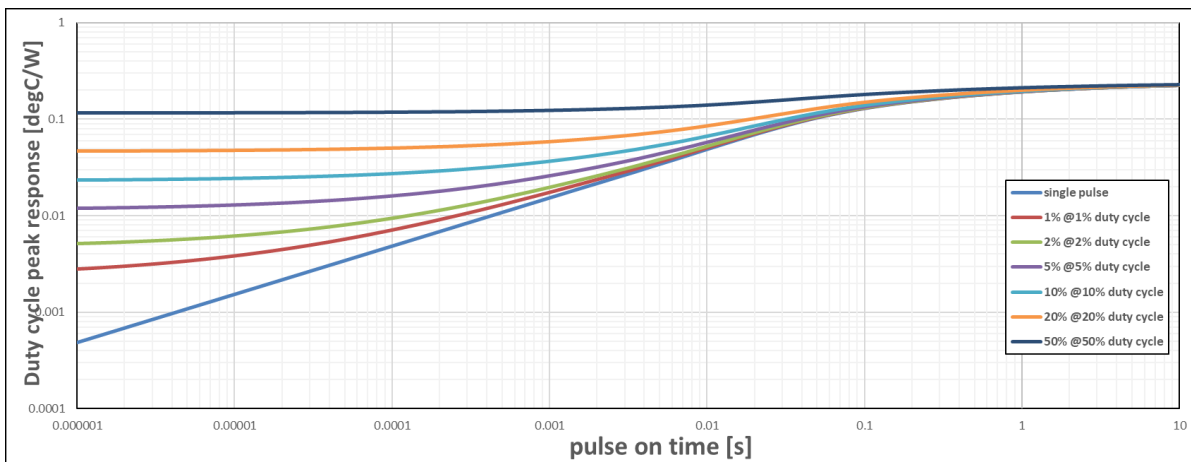

Figure 16. Transient Thermal Impedance (T2, T3)

NXH600N65L4Q2F2

TYPICAL CHARACTERISTICS – IGBT T2, T3 AND DIODE D1, D2, D3, D4 (continued)

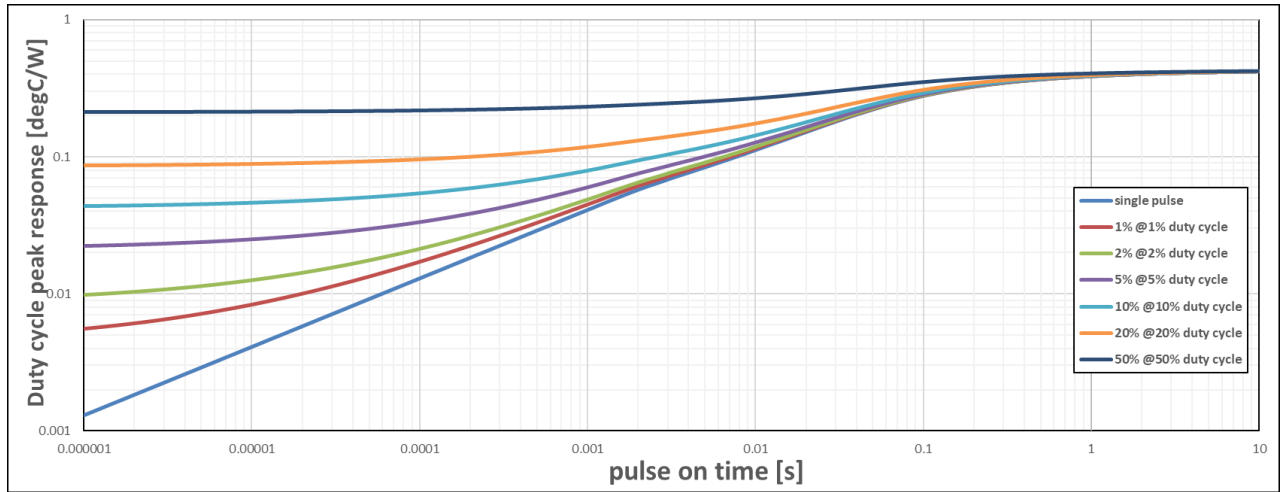

Figure 17. Transient Thermal Impedance (D1, D2, D3, D4)

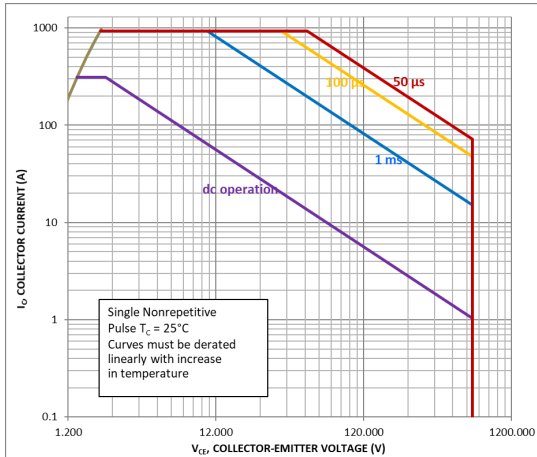

Figure 18. FBSOA (T2, T3)

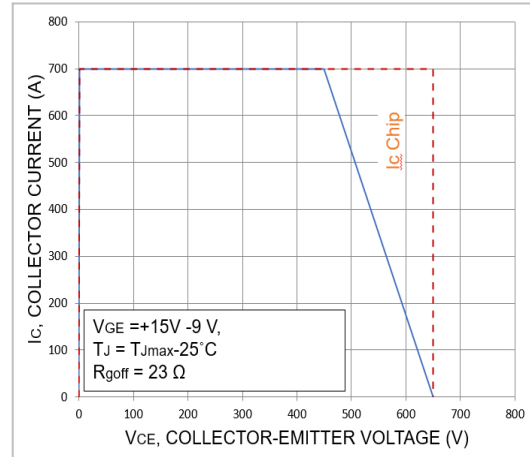

Figure 19. RBSOA (T2, T3)

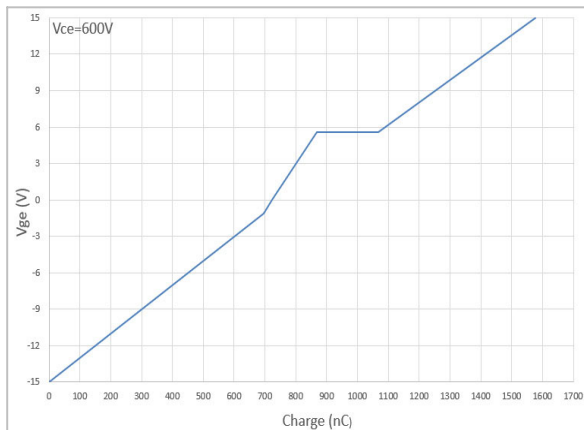

Figure 20. Gate Voltage vs. Gate Charge

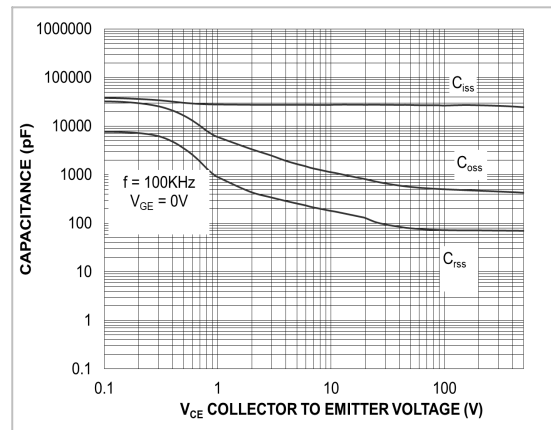

Figure 21. Capacitance

NXH600N65L4Q2F2

TYPICAL CHARACTERISTICS – IGBT T2, T3 AND DIODE D1, D2, D3, D4 (continued)

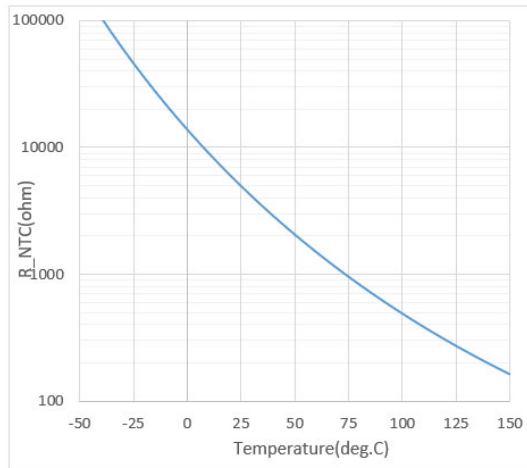

Figure 22. NTC vs. Temperature Curve

NXH600N65L4Q2F2

TYPICAL CHARACTERISTICS – T1/T4 IGBT COMUTATES D5/D6 DIODE

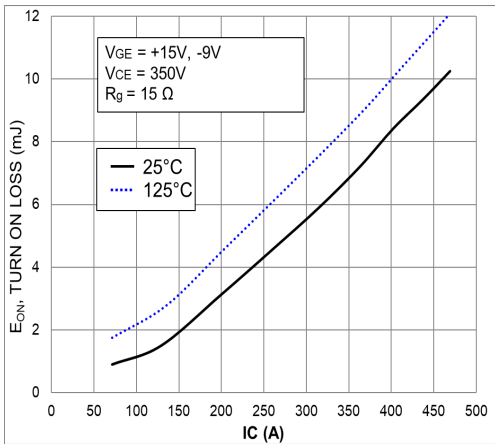

Figure 23. Typical Switching Loss Eon vs. IC

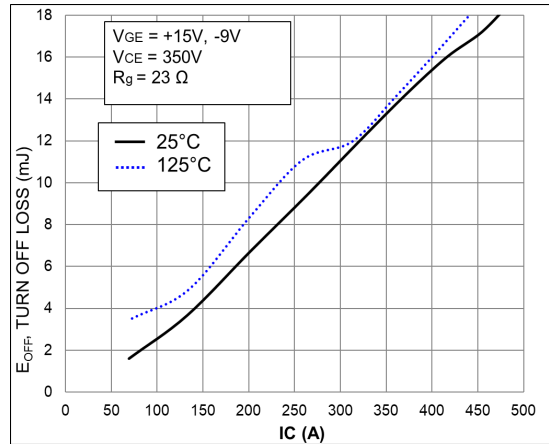

Figure 24. Typical Switching Loss Eoff vs. IC

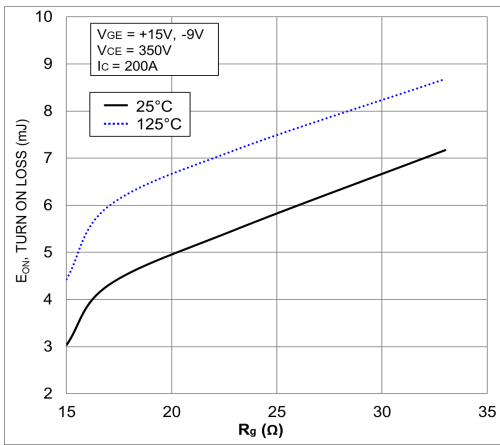

Figure 25. Typical Switching Eon vs. R_G

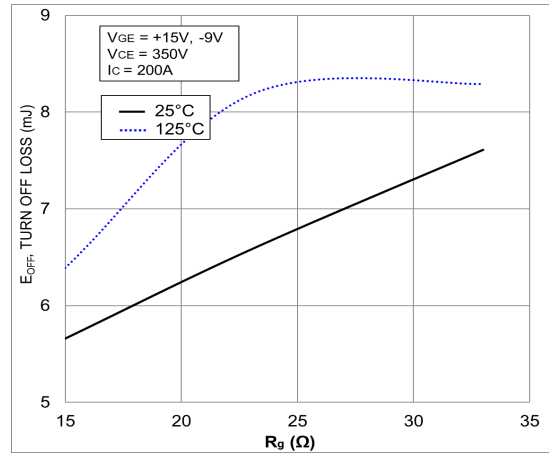

Figure 26. Typical Switching Eoff vs. R_G

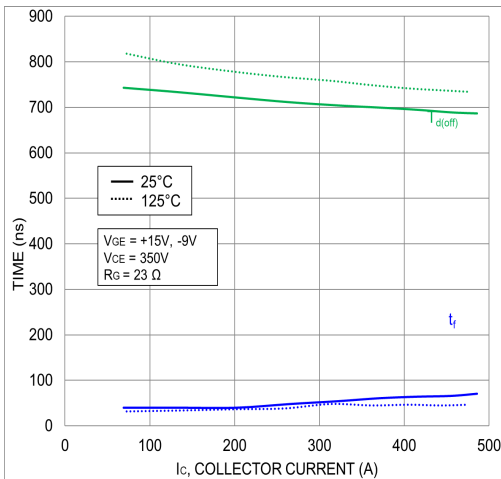

Figure 27. Typical Switching Time vs. IC

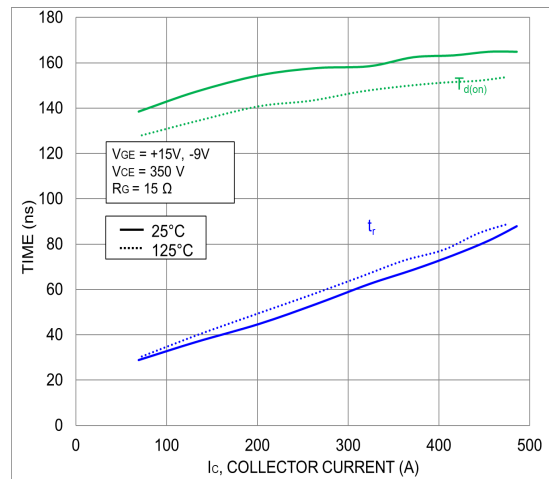

Figure 28. Typical Switching Time vs. IC

NXH600N65L4Q2F2

TYPICAL CHARACTERISTICS – T1/T4 IGBT COMUTATES D5/D6 DIODE (continued)

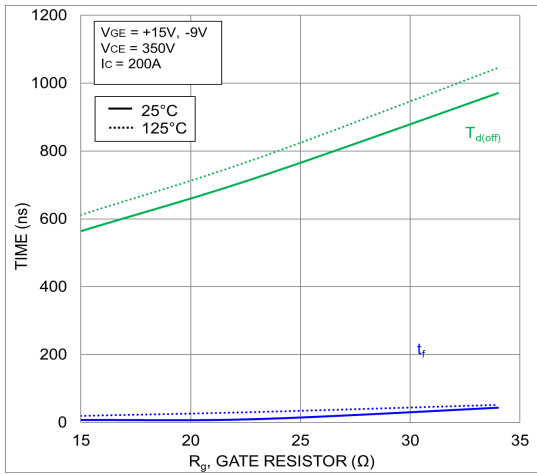

Figure 29. Typical Switching Time vs. R_G

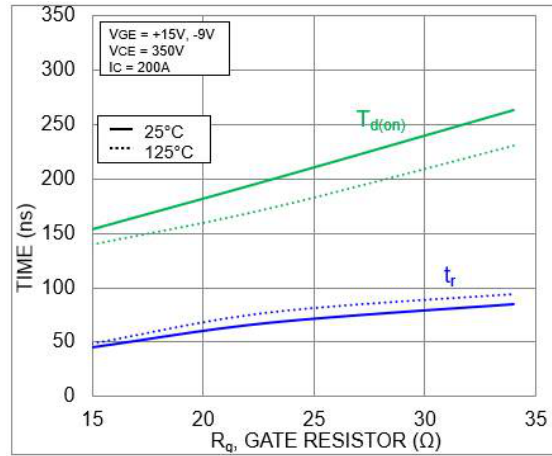

Figure 30. Typical Switching Time vs. R_G

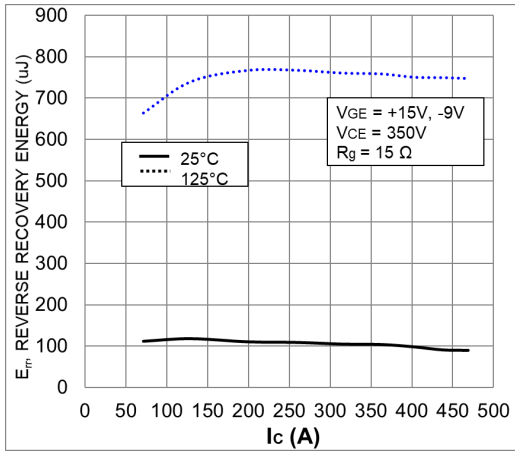

Figure 31. Typical Reverse Recovery Energy vs. I_C

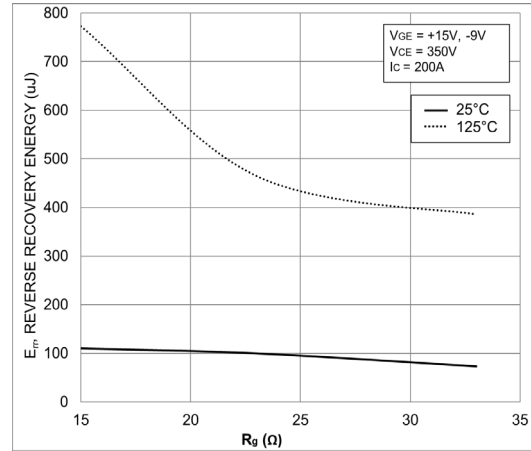

Figure 32. Typical Reverse Recovery Energy vs. R_g

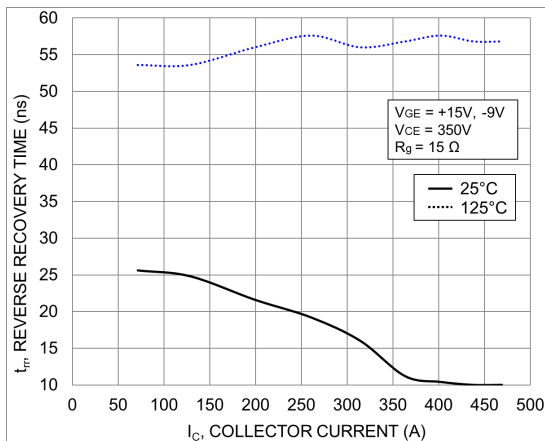

Figure 33. Typical Reverse Recovery Time vs. I_C

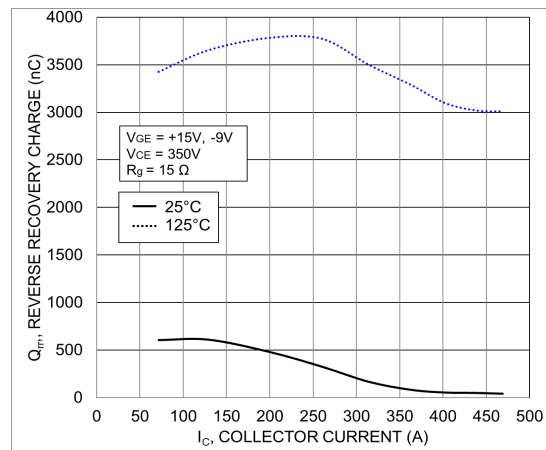

Figure 34. Typical Reverse Recovery Charge vs. I_C

NXH600N65L4Q2F2

TYPICAL CHARACTERISTICS – T1/T4 IGBT COMUTATES D5/D6 DIODE (continued)

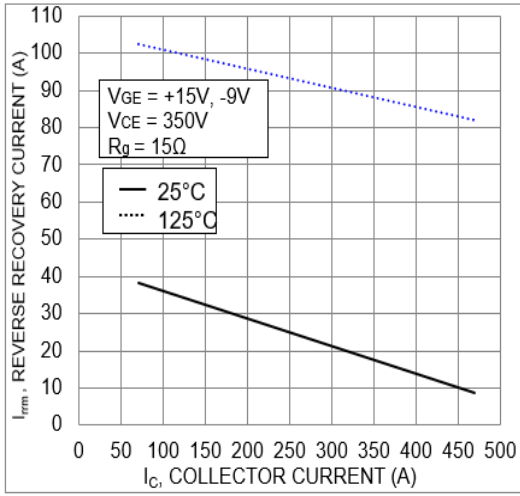

Figure 35. Typical Reverse Recovery Current vs. IC

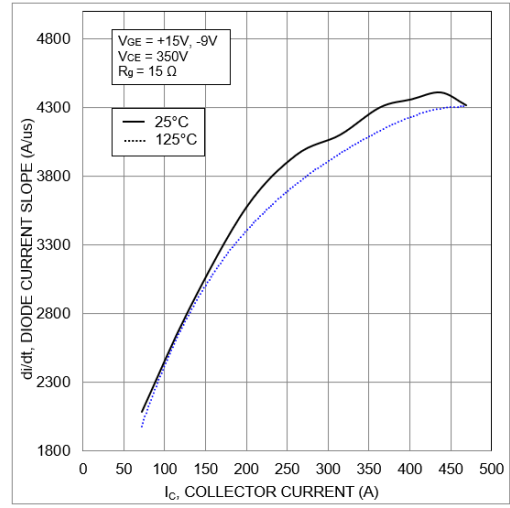

Figure 36. Typical di/dt vs. IC

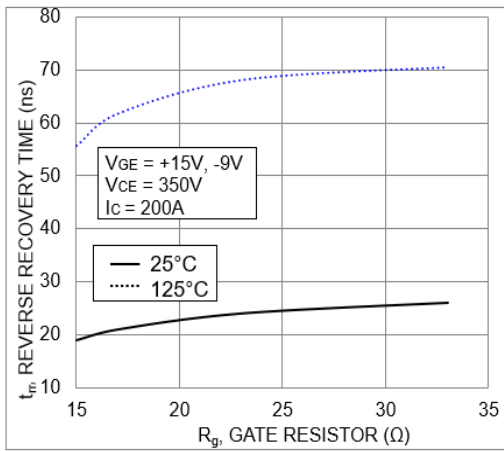

Figure 37. Typical Reverse Recovery Time vs. Rg

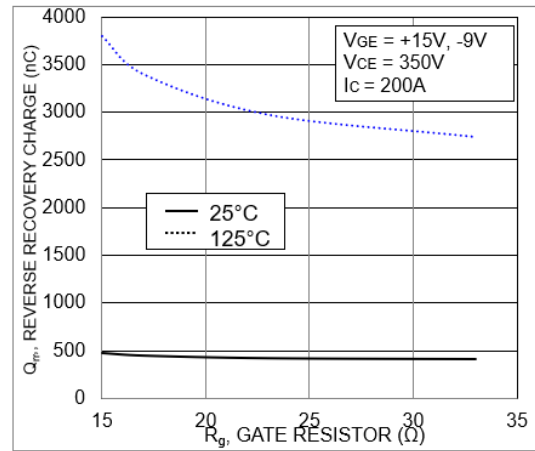

Figure 38. Typical Reverse Recovery Charge vs. Rg

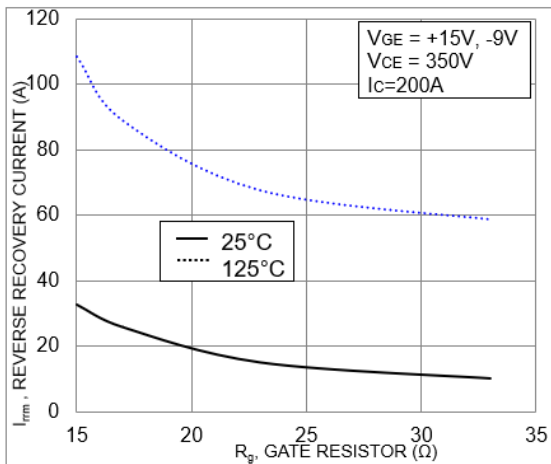

Figure 39. Typical Reverse Recovery Current vs. Rg

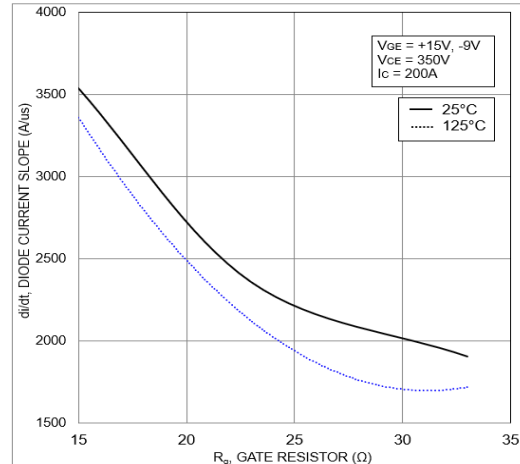

Figure 40. Typical di/dt vs. Rg

TYPICAL CHARACTERISTICS – T2/T3 IGBT COMUTATES D1/D4 DIODE

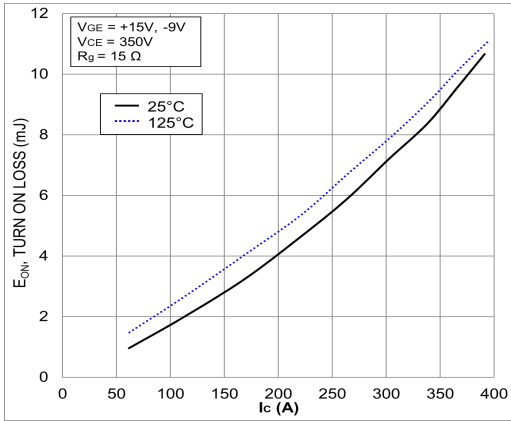

Figure 41. Typical Switching Loss Eon vs. IC

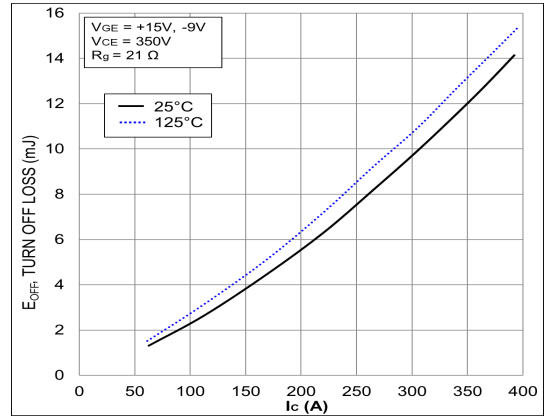

Figure 42. Typical Switching Loss Eoff vs. IC

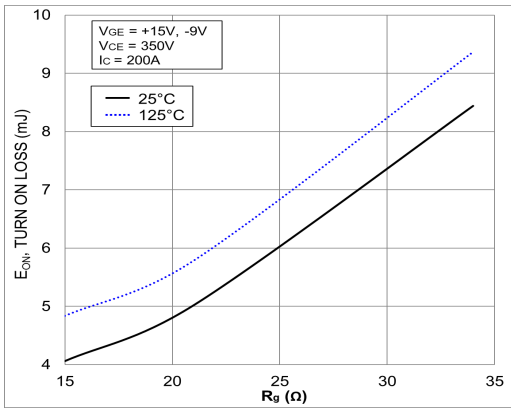

Figure 43. Typical Switching Loss Eon vs. Rg

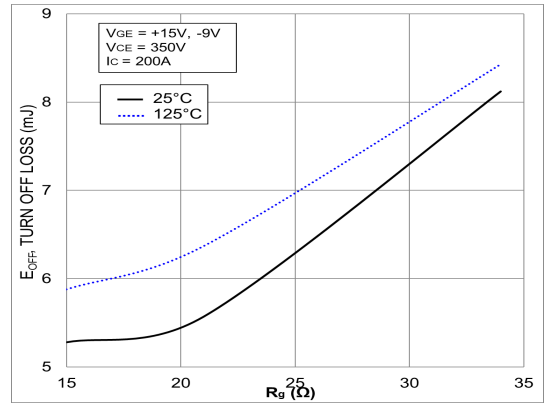

Figure 44. Typical Switching Loss Eoff vs. Rg

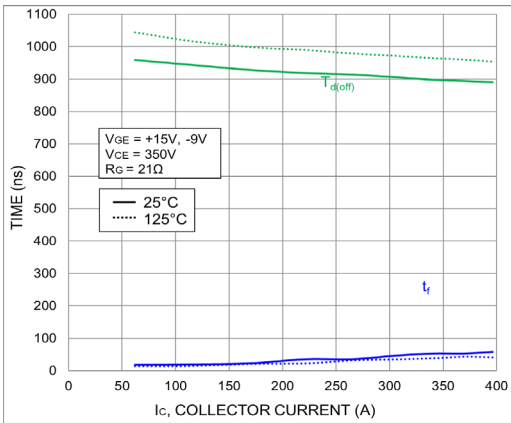

Figure 45. Typical Turn-Off Switching Time vs. IC

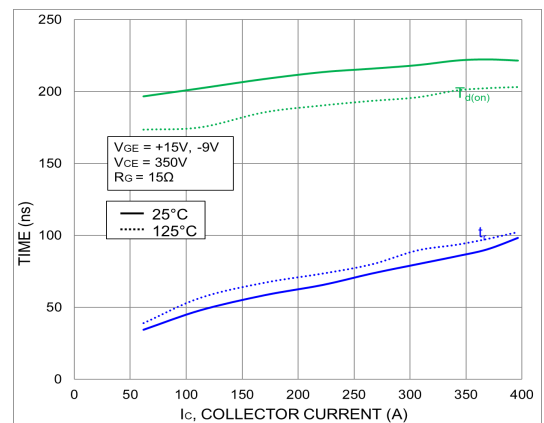

Figure 46. Typical Turn-On Switching Time vs. IC

NXH600N65L4Q2F2

TYPICAL CHARACTERISTICS – T2/T3 IGBT COMUTATES D1/D4 DIODE (continued)

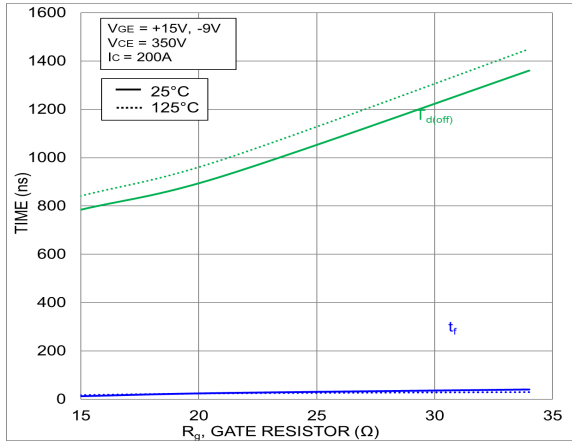

Figure 47. Typical Turn-Off Switching Time vs. Rg

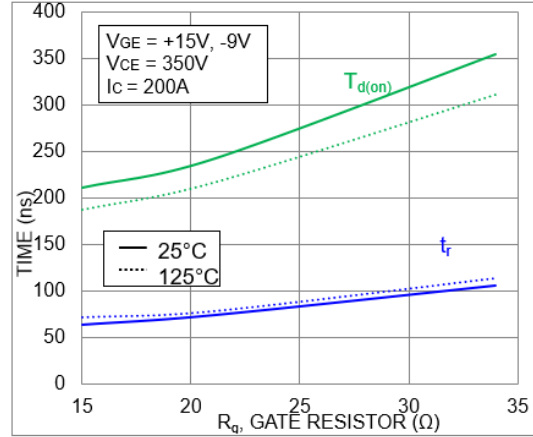

Figure 48. Typical Turn-On Switching Time vs. Rg

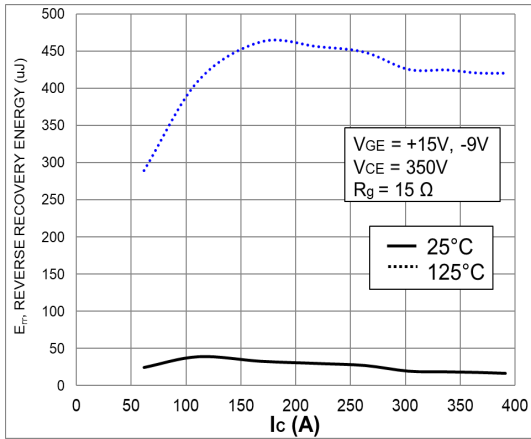

Figure 49. Typical Reverse Recovery Energy Loss vs. IC

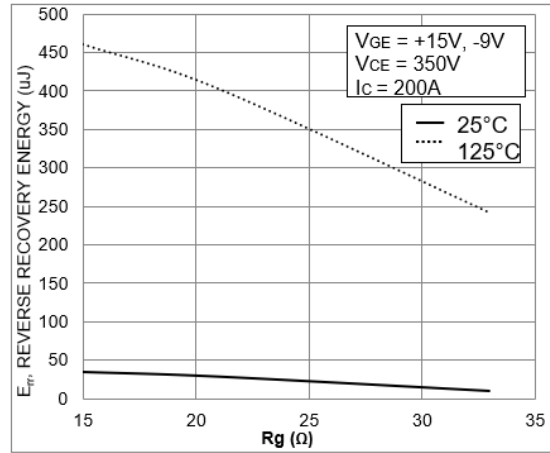

Figure 50. Typical Reverse Recovery Energy Loss vs. Rg

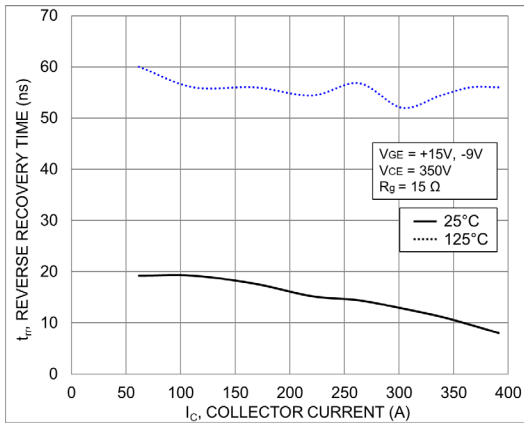

Figure 51. Typical Reverse Recovery Time vs. IC

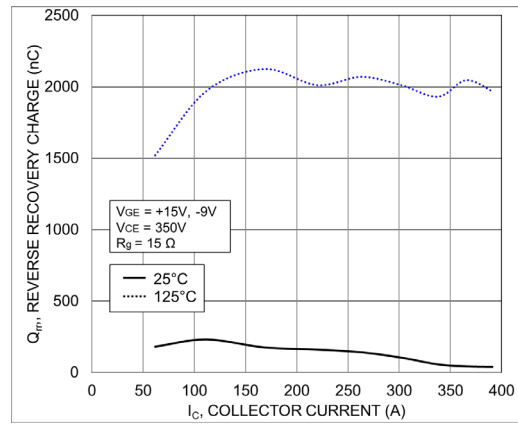

Figure 52. Typical Reverse Recovery Charge vs. IC

NXH600N65L4Q2F2

TYPICAL CHARACTERISTICS – T2/T3 IGBT COMUTATES D1/D4 DIODE (continued)

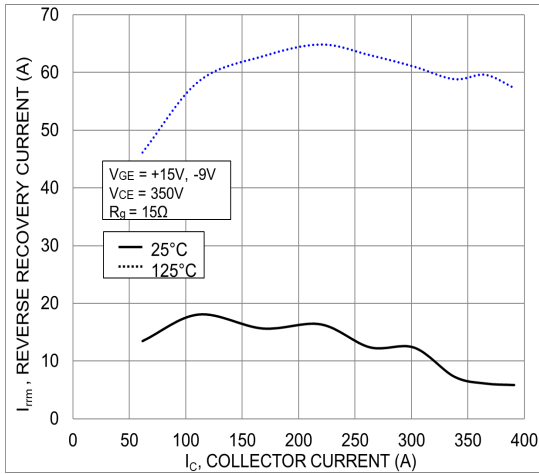

Figure 53. Typical Reverse Recovery Current vs. IC

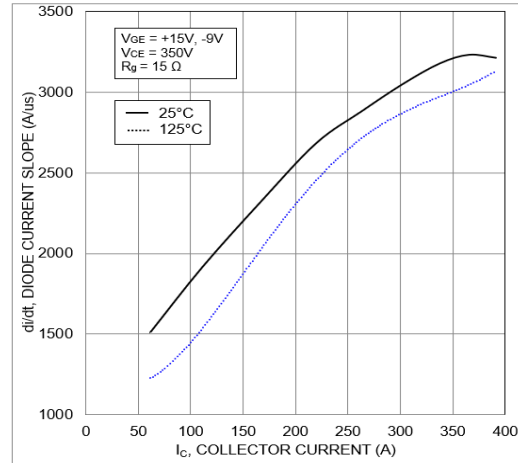

Figure 54. Typical di/dt Current Slope vs. IC

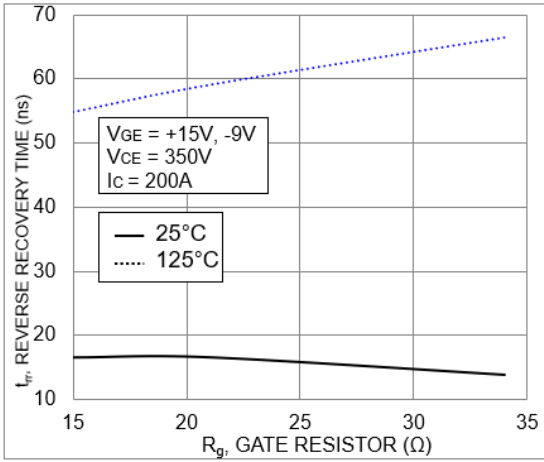

Figure 55. Typical Reverse Recovery Time vs. Rg

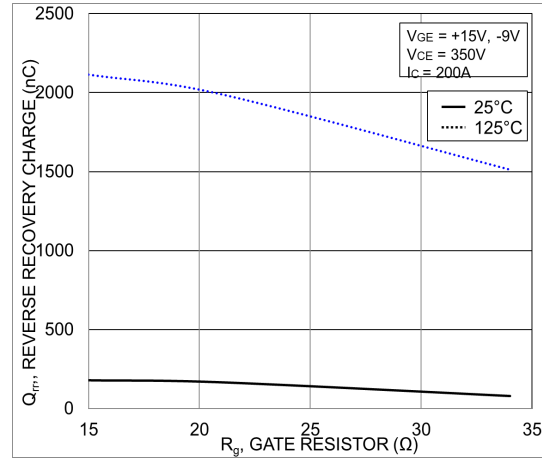

Figure 56. Typical Reverse Recovery Charge vs. Rg

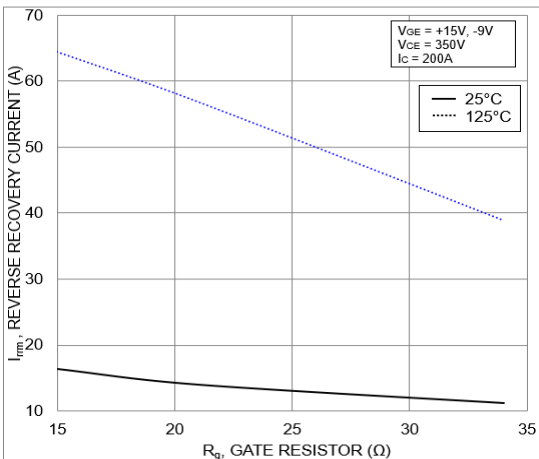

Figure 57. Typical Reverse Recovery Peak Current vs. Rg

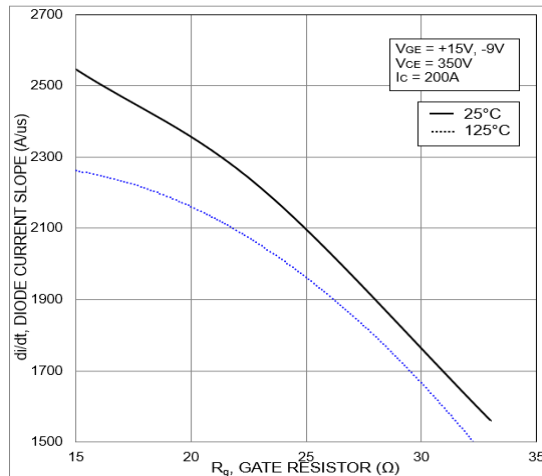

Figure 58. Typical di/dt vs. Rg

NXH600N65L4Q2F2

ORDERING INFORMATION

Device Order Number	Marking	Package	Shipping
NXH600N65L4Q2F2SG	NXH600N65L4Q2F2SG	Q2PACK (Pb – Free and Halide – Free)	12 Units / Blister Tray
NXH600N65L4Q2F2PG	NXH600N65L4Q2F2PG	Q2PACK (Pb – Free and Halide – Free)	12 Units / Blister Tray

MECHANICAL CASE OUTLINE

PACKAGE DIMENSIONS



PIM41, 93x47 (SOLDER PIN) CASE 180BC ISSUE O

DATE 27 SEP 2021

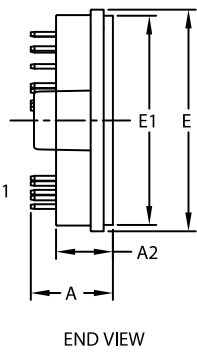
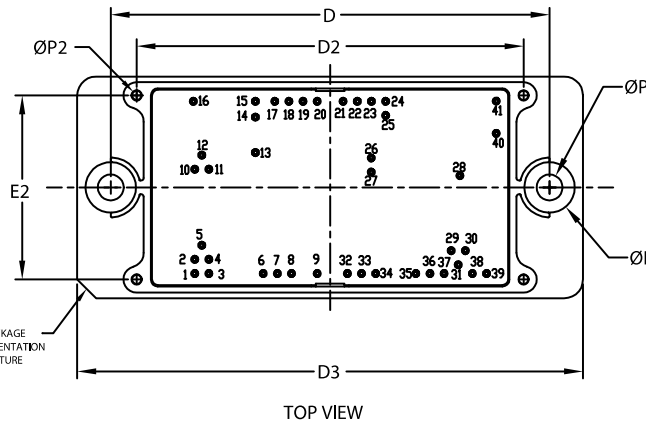
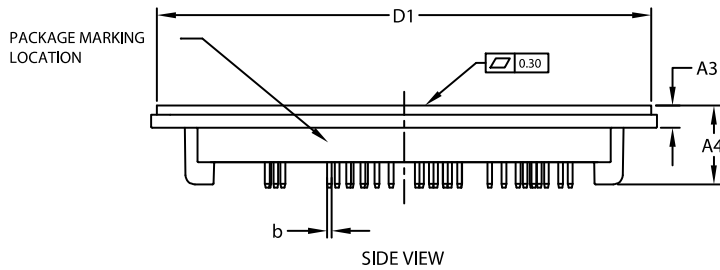

- NOTES:
1. DIMENSIONING AND TOLERANCING PER ASME Y14.5M, 2009
 2. CONTROLLING DIMENSION : MILLIMETERS
 3. DIMENSIONS b AND b1 APPLY TO THE PLATED TERMINALS AND ARE MEASURED AT DIMENSION A1
 4. PIN POSITION TOLERANCE IS ± 0.4mm
 5. PACKAGE MARKING IS LOCATED AS SHOWN ON THE SIDE OPPOSITE THE PACKAGE ORIENTATION FEATURES

DIM	MILLIMETERS		
	MIN.	NOM.	MAX.
A	16.90	17.30	17.70
A2	11.70	12.00	12.30
A3	4.40	4.70	5.00
A4	16.40	16.70	17.00
b	0.95	1.00	1.05
D	92.90	93.00	93.10
D1	104.45	104.75	105.05
D2	81.80	82.00	82.20
D3	106.90	107.20	107.50
E	46.70	47.00	47.30
E1	44.10	44.40	44.70
E2	38.80	39.00	39.20
P	5.40	5.50	5.60
P1	10.60	10.70	10.80
P2	1.80	2.00	2.20

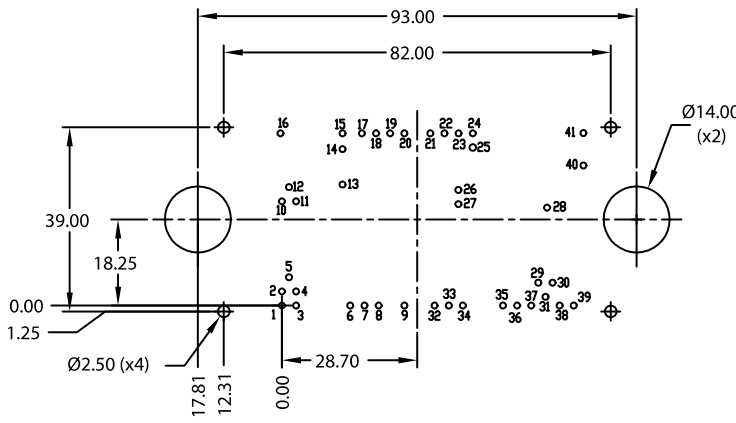

RECOMMENDED MOUNTING PATTERN

* For additional information on our Pb-Free strategy and soldering details, please download the ON Semiconductor Soldering and Mounting Techniques Reference Manual, SOLDERRM/D.

NOTE 4

PIN	PIN POSITION		PIN	PIN POSITION	
	X	Y		X	Y
1	0.00	0.00	23	37.45	36.50
2	0.00	3.00	24	40.45	36.50
3	3.00	0.00	25	40.45	33.50
4	3.00	3.00	26	37.40	24.50
5	1.50	6.00	27	37.40	21.50
6	14.50	0.00	28	56.20	20.75
7	17.50	0.00	29	54.35	4.85
8	20.50	0.00	30	57.35	4.85
9	25.95	0.00	31	55.85	1.85
10	0.00	22.10	32	32.35	0.00
11	3.00	22.10	33	35.35	0.00
12	1.50	25.10	34	38.35	0.00
13	12.85	25.65	35	46.85	0.00
14	12.85	33.15	36	49.85	0.00
15	12.85	36.50	37	52.85	0.00
16	-0.30	36.50	38	58.85	0.00
17	16.95	36.50	39	61.85	0.00
18	19.95	36.50	40	63.90	29.70
19	22.95	36.50	41	63.90	36.55
20	25.95	36.50			
21	31.45	36.50			
22	34.45	36.50			

DOCUMENT NUMBER:	98AON38148H	Electronic versions are uncontrolled except when accessed directly from the Document Repository. Printed versions are uncontrolled except when stamped "CONTROLLED COPY" in red.
DESCRIPTION:	PIM41, 93x47 (SOLDER PIN)	PAGE 1 OF 2

onsemi and ONSEMI are trademarks of Semiconductor Components Industries, LLC dba onsemi or its subsidiaries in the United States and/or other countries. onsemi reserves the right to make changes without further notice to any products herein. onsemi makes no warranty, representation or guarantee regarding the suitability of its products for any particular purpose, nor does onsemi assume any liability arising out of the application or use of any product or circuit, and specifically disclaims any and all liability, including without limitation special, consequential or incidental damages. onsemi does not convey any license under its patent rights nor the rights of others.

**MECHANICAL CASE OUTLINE
PACKAGE DIMENSIONS**

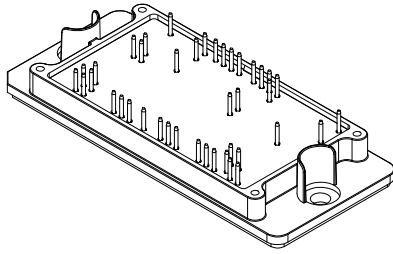

PIM41, 93x47 (SOLDER PIN)
CASE 180BC
ISSUE O

DATE 27 SEP 2021

**GENERIC
MARKING DIAGRAM***

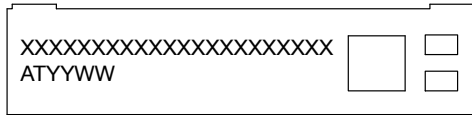

FRONTSIDE MARKING

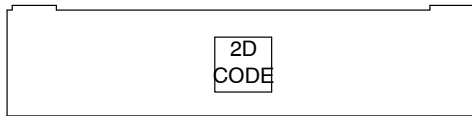

BACKSIDE MARKING

XXXXX = Specific Device Code
AT = Assembly & Test Site Code
YYWW = Year and Work Week Code

*This information is generic. Please refer to device data sheet for actual part marking. Pb-Free indicator, "G" or microdot "▪", may or may not be present. Some products may not follow the Generic Marking.

DOCUMENT NUMBER:	98AON38148H	Electronic versions are uncontrolled except when accessed directly from the Document Repository. Printed versions are uncontrolled except when stamped "CONTROLLED COPY" in red.
DESCRIPTION:	PIM41, 93x47 (SOLDER PIN)	PAGE 2 OF 2

onsemi and ONSEMI are trademarks of Semiconductor Components Industries, LLC dba onsemi or its subsidiaries in the United States and/or other countries. onsemi reserves the right to make changes without further notice to any products herein. onsemi makes no warranty, representation or guarantee regarding the suitability of its products for any particular purpose, nor does onsemi assume any liability arising out of the application or use of any product or circuit, and specifically disclaims any and all liability, including without limitation special, consequential or incidental damages. onsemi does not convey any license under its patent rights nor the rights of others.

www.onsemi.com

MECHANICAL CASE OUTLINE PACKAGE DIMENSIONS



PIM41, 93x47 (PRESS FIT) CASE 180HD ISSUE O

DATE 22 SEP 2021

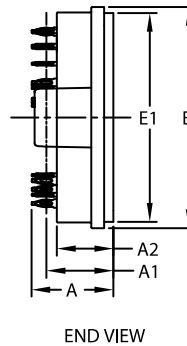
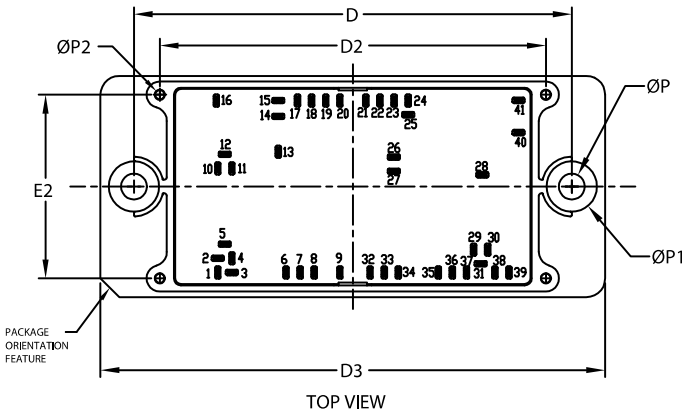
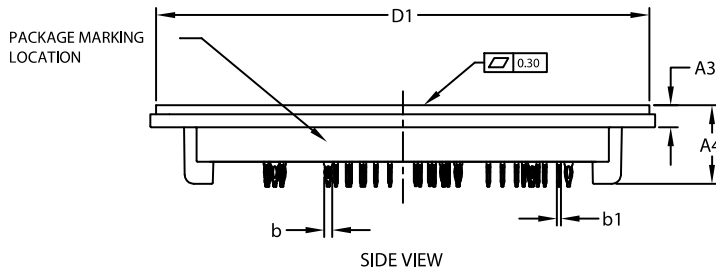

NOTES:

1. DIMENSIONING AND TOLERANCING PER ASME Y14.5M, 2009
2. CONTROLLING DIMENSION : MILLIMETERS
3. DIMENSIONS b AND b1 APPLY TO THE PLATED TERMINALS AND ARE MEASURED AT DIMENSION A1
4. PIN POSITION TOLERANCE IS ± 0.4mm
5. PACKAGE MARKING IS LOCATED AS SHOWN ON THE SIDE OPPOSITE THE PACKAGE ORIENTATION FEATURES

DIM	MILLIMETERS		
	MIN.	NOM.	MAX.
A	16.90	17.30	17.70
A1	14.18 (REF)		
A2	11.70	12.00	12.30
A3	4.40	4.70	5.00
A4	16.40	16.70	17.00
b	1.61	1.66	1.71
b1	0.75	0.80	0.85
D	92.90	93.00	93.10
D1	104.45	104.75	105.05
D2	81.80	82.00	82.20
D3	106.90	107.20	107.50
E	46.70	47.00	47.30
E1	44.10	44.40	44.70
E2	38.80	39.00	39.20
P	5.40	5.50	5.60
P1	10.60	10.70	10.80
P2	1.80	2.00	2.20

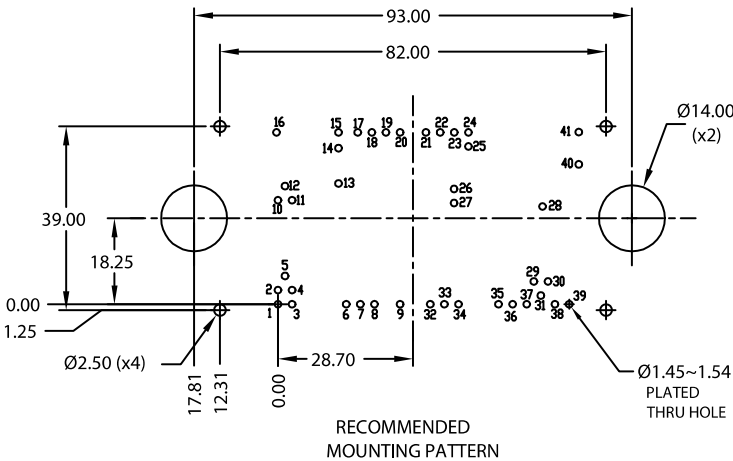

NOTE 4

PIN	PIN POSITION		PIN	PIN POSITION	
	X	Y		X	Y
1	0.00	0.00	23	37.45	36.50
2	0.00	3.00	24	40.45	36.50
3	3.00	0.00	25	40.45	33.50
4	3.00	3.00	26	37.40	24.50
5	1.50	6.00	27	37.40	21.50
6	14.50	0.00	28	56.20	20.75
7	17.50	0.00	29	54.35	4.85
8	20.50	0.00	30	57.35	4.85
9	25.95	0.00	31	55.85	1.85
10	0.00	22.10	32	32.35	0.00
11	3.00	22.10	33	35.35	0.00
12	1.50	25.10	34	38.35	0.00
13	12.85	25.65	35	46.85	0.00
14	12.85	33.15	36	49.85	0.00
15	12.85	36.50	37	52.85	0.00
16	-0.30	36.50	38	58.85	0.00
17	16.95	36.50	39	61.85	0.00
18	19.95	36.50	40	63.90	29.70
19	22.95	36.50	41	63.90	36.55
20	25.95	36.50			
21	31.45	36.50			
22	34.45	36.50			

DOCUMENT NUMBER:	98AON38009H	Electronic versions are uncontrolled except when accessed directly from the Document Repository. Printed versions are uncontrolled except when stamped "CONTROLLED COPY" in red.
DESCRIPTION:	PIM41, 93x47 (PRESS FIT)	PAGE 1 OF 2

onsemi and ONSEMI are trademarks of Semiconductor Components Industries, LLC dba onsemi or its subsidiaries in the United States and/or other countries. onsemi reserves the right to make changes without further notice to any products herein. onsemi makes no warranty, representation or guarantee regarding the suitability of its products for any particular purpose, nor does onsemi assume any liability arising out of the application or use of any product or circuit, and specifically disclaims any and all liability, including without limitation special, consequential or incidental damages. onsemi does not convey any license under its patent rights nor the rights of others.

MECHANICAL CASE OUTLINE
PACKAGE DIMENSIONS

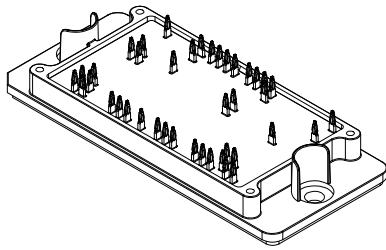

PIM41, 93x47 (PRESS FIT)
CASE 180HD
ISSUE O

DATE 22 SEP 2021

GENERIC MARKING DIAGRAM*

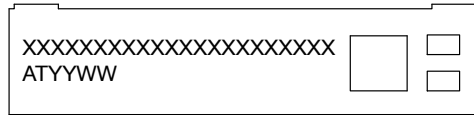

FRONTSIDE MARKING

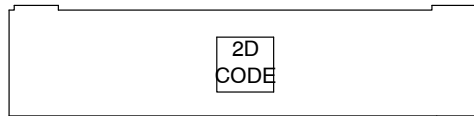

BACKSIDE MARKING

XXXXX = Specific Device Code
AT = Assembly & Test Site Code
YYWW = Year and Work Week Code

*This information is generic. Please refer to device data sheet for actual part marking. Pb-Free indicator, "G" or microdot "▪", may or may not be present. Some products may not follow the Generic Marking.

DOCUMENT NUMBER:	98AON38009H	Electronic versions are uncontrolled except when accessed directly from the Document Repository. Printed versions are uncontrolled except when stamped "CONTROLLED COPY" in red.
DESCRIPTION:	PIM41, 93x47 (PRESS FIT)	PAGE 2 OF 2

onsemi and ONSEMI are trademarks of Semiconductor Components Industries, LLC dba onsemi or its subsidiaries in the United States and/or other countries. onsemi reserves the right to make changes without further notice to any products herein. onsemi makes no warranty, representation or guarantee regarding the suitability of its products for any particular purpose, nor does onsemi assume any liability arising out of the application or use of any product or circuit, and specifically disclaims any and all liability, including without limitation special, consequential or incidental damages. onsemi does not convey any license under its patent rights nor the rights of others.

www.onsemi.com

onsemi, **Onsemi**, and other names, marks, and brands are registered and/or common law trademarks of Semiconductor Components Industries, LLC dba "**onsemi**" or its affiliates and/or subsidiaries in the United States and/or other countries. **onsemi** owns the rights to a number of patents, trademarks, copyrights, trade secrets, and other intellectual property. A listing of **onsemi**'s product/patent coverage may be accessed at www.onsemi.com/site/pdf/Patent-Marking.pdf. **onsemi** reserves the right to make changes at any time to any products or information herein, without notice. The information herein is provided "as-is" and **onsemi** makes no warranty, representation or guarantee regarding the accuracy of the information, product features, availability, functionality, or suitability of its products for any particular purpose, nor does **onsemi** assume any liability arising out of the application or use of any product or circuit, and specifically disclaims any and all liability, including without limitation special, consequential or incidental damages. Buyer is responsible for its products and applications using **onsemi** products, including compliance with all laws, regulations and safety requirements or standards, regardless of any support or applications information provided by **onsemi**. "Typical" parameters which may be provided in **onsemi** data sheets and/or specifications can and do vary in different applications and actual performance may vary over time. All operating parameters, including "Typicals" must be validated for each customer application by customer's technical experts. **onsemi** does not convey any license under any of its intellectual property rights nor the rights of others. **onsemi** products are not designed, intended, or authorized for use as a critical component in life support systems or any FDA Class 3 medical devices or medical devices with a same or similar classification in a foreign jurisdiction or any devices intended for implantation in the human body. Should Buyer purchase or use **onsemi** products for any such unintended or unauthorized application, Buyer shall indemnify and hold **onsemi** and its officers, employees, subsidiaries, affiliates, and distributors harmless against all claims, costs, damages, and expenses, and reasonable attorney fees arising out of, directly or indirectly, any claim of personal injury or death associated with such unintended or unauthorized use, even if such claim alleges that **onsemi** was negligent regarding the design or manufacture of the part. **onsemi** is an Equal Opportunity/Affirmative Action Employer. This literature is subject to all applicable copyright laws and is not for resale in any manner.

ADDITIONAL INFORMATION

TECHNICAL PUBLICATIONS:

Technical Library: www.onsemi.com/design/resources/technical-documentation
onsemi Website: www.onsemi.com

ONLINE SUPPORT: www.onsemi.com/support

For additional information, please contact your local Sales Representative at www.onsemi.com/support/sales