

## 30W BASEPLATE COOLED

DC-HVDC CONVERTER

The HRL30 series, is a miniature 30W regulated high voltage DC-DC converter product line providing voltages up to 6kV. HRL30 offers both voltage and current mode controls and monitors making the high voltage integration easier.

This product deploys a proprietary design which delivers accurate and reliable high voltage at higher efficiency with low EMI. Small size, digital compatible voltage and current monitors and controls, and superior thermal management makes it an ideal product for a wide range of high voltage applications.



### Features

- +24VDC input (22 to 30V)
- Output voltage & current regulated
- 0 to 100% programmable output & current
- Voltage & current monitor outputs
- Operating temperature: -40°C to +70°C
- Short circuit, arc, and overload protections
- On-board +5V reference
- Efficiency >80%
- Output ripple as low as 0.01%
- Premier thermal performance
- UL 60950 and 62368 approved
- 3 year warranty

### Typical Applications



- Mass Spectrometry
- Electrophoresis
- E-beam/Ion Beam
- Electrostatic Chuck
- Capacitor Charging
- High Voltage Bias
- Photo Multiplier Tube
- Scanning Electron Microscopy

### Dimensions

3.00" x 1.50" x 0.75" (76.2 x 38.1 x 18.6 mm)

### Models & Ratings

Model Number	Output Voltage	Model Number	Output Voltage	Output Current	Input Current		Ripple & Noise
					No Load <sup>(1)</sup>	Full Load	
HRL3024S200P	0 to +200V	HRL3024S200N	0 to -200V	150mA	100mA	1.5A	≤0.05%
HRL3024S350P	0 to +350V	HRL3024S350N	0 to -350V	85.7mA	100mA	1.5A	≤0.05%
HRL3024S600P	0 to +600V	HRL3024S600N	0 to -600V	50.0mA	100mA	1.5A	≤0.01%
HRL3024S1K0P	0 to +1000V	HRL3024S1K0N	0 to -1000V	30.0mA	100mA	1.5A	≤0.04%
HRL3024S1K5P	0 to +1500V	HRL3024S1K5N	0 to -1500V	20.0mA	100mA	1.5A	≤0.05%
HRL3024S2K0P	0 to +2000V	HRL3024S2K0N	0 to -2000V	15.0mA	100mA	1.5A	≤0.05%
HRL3024S2K5P	0 to +2500V	HRL3024S2K5N	0 to -2500V	12.0mA	100mA	1.5A	≤0.05%
HRL3024S3K0P	0 to +3000V	HRL3024S3K0N	0 to -3000V	10.0mA	100mA	1.5A	≤0.05%
HRL3024S4K0P	0 to +4000V	HRL3024S4K0N	0 to -4000V	7.5mA	100mA	1.5A	≤0.05%
HRL3024S5K0P	0 to +5000V	HRL3024S5K0N	0 to -5000V	6.0mA	100mA	1.5A	≤0.04%
HRL3024S6K0P	0 to +6000V	HRL3024S6K0N	0 to -6000V	5.0mA	100mA	1.5A	≤0.04%

- Notes:**
1. Typical at 24V input
  2. Specifications after 30-minute warm up, at full load, maximum output voltage and 25°C, unless otherwise indicated.
  3. No current derating over temperature range.
  4. Proper thermal management techniques are required to maintain safe case temperature at maximum power output.

## Input

Characteristic	Minimum	Typical	Maximum	Units	Notes & Conditions
Input Voltage Range	22	24	30	VDC	24V nominal
Input Current			1.55	A	See Models and Ratings table
Input Filter	Internal Pi filter				
Input Undervoltage Lockout	OFF/Shutdown @ <20.5V, ON/Restart @ >21.5V				
Input Overvoltage Protection	OFF/Shutdown @ >31.5V, ON/Restart @ <30.5V				
Voltage Programming Input	0		5	VDC	Analog DC voltage controls output 0 to 100%, see Signals.
Overprogramming Protection		5.5		VDC	110% maximum voltage and current

## Output

Characteristic	Minimum	Typical	Maximum	Units	Notes & Conditions
Output Voltage			6000	VDC	See Models & Ratings table
Output Current			150	mA	See Models & Ratings table
Output Programming	0		100	%	Output Voltage/Current is programmable via Analog DC Voltage Programming Input (Vpgm)
Output Calibration Range		±5		%	Potentiometer, see Mechanical Details
Initial Setpoint Accuracy		±1		%	At maximum Vpgm, No Load
Linearity: Output vs Program			1.5	%	10 to 100% output
Minimum Load	No minimum load required				
Start Up Response	See Application Notes				
Line Regulation			0.01	%	100% Vpgm, Full Load, (min to max input)
Load Regulation			0.01	%	100% Vpgm, 24Vin, [NL to FL]
Transient Response	Overshoot <5%, (For 50% - 100% - 50% load change). Load transient duration <25msec (Vout returns to within 1%)				
Ripple and Noise	0.01		0.05	%	1MHz bandwidth, see Models and Ratings Table
Temperature Coefficient		100		ppm/°C	
Stability			100	ppm/8hrs	After 30 minute warm up
Short Circuit, Overload					Rectangular V/I characteristics
Overtemperature Protection		95		°C	Shutdown @ 95°C typical, ±5% at the hot spot

## General

Characteristic	Minimum	Typical	Maximum	Units	Notes & Conditions
Efficiency	80	85		%	Max Vp <sub>gm</sub> , Full Load
Isolation: Input to Output	N/A – Input ground is internally connected to output ground				
Isolated Baseplate			1500	VDC	
Construction	DAP case. Solid vacuum encapsulation, UL 94 V-0 rated				
Switching Frequency		100		kHz	
Mean Time Between Failure	1			Mhrs	MIL-HDBK-217F, +25°C GB
Weight		0.26 (120)		lb (g)	

## Environmental

Characteristic	Minimum	Typical	Maximum	Units	Notes & Conditions
Operating (Baseplate) Temperature	-40		+70	°C	
Storage Temperature	-55		+105	°C	
Cooling	Natural convection				
Humidity			95	%RH	Non-condensing

## Safety Approvals

Certification	Standard	Notes & Conditions
UL	IEC/UL/CSA/EN 62368, 60950	
CE	Meets all applicable directives	
UKCA	Meets all applicable legislation	

## Signals

Characteristic	Pin	Function	Description
-VIN	1	Input Ground	Input Power Ground
DISABLE	2	Input: Remote Disable	Open or No Connect turns unit ON. Ground connection turns unit OFF
VREF	3	Output: Voltage Reference	+5V ±2% - current <10mA
SGND	4	Signal Ground	Signal Ground
VPGM	5	Input: Voltage Programming	0V to +5V signal programs V <sub>out</sub> from 0 to 100%, Z=100kΩ
VMON	6	Output: Voltage Monitor	0V to +5V output measures 0 to 100% V <sub>out</sub> , 1.5% accuracy
IPGM	7	Input: Current Programming	0V to +5V signal programs I <sub>out</sub> from 0 to 100%, Z=100kΩ
IMON	8	Output: Current Monitor	0V to +5V output measures 0 to 100% I <sub>out</sub> , 1.5% accuracy.
N/C	9	N/A	
N/C	10	N/A	
N/C	11	N/A	
+VIN	12	Input: 24Vin	Power Input
HVOUT	13	HV Output	High Voltage Output
HVRTN	14	HV Return	High Voltage Return

## Mechanical Details

Standard

TOP VIEW

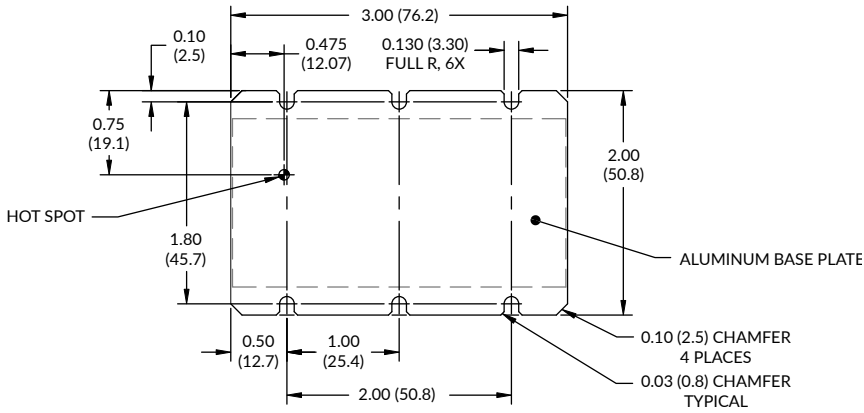

RECOMMENDED PCB LAYOUT TOP VIEW

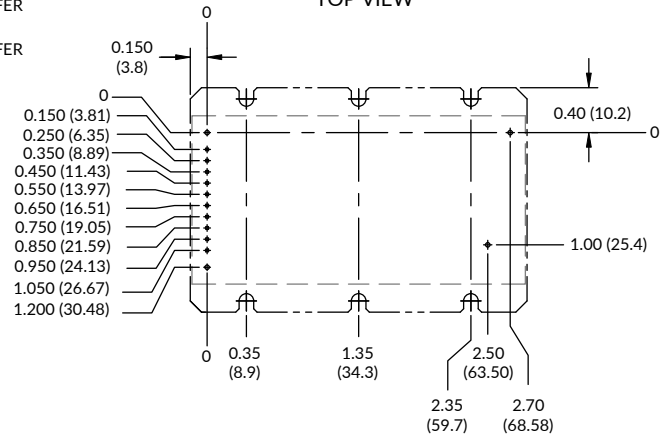

BOTTOM VIEW

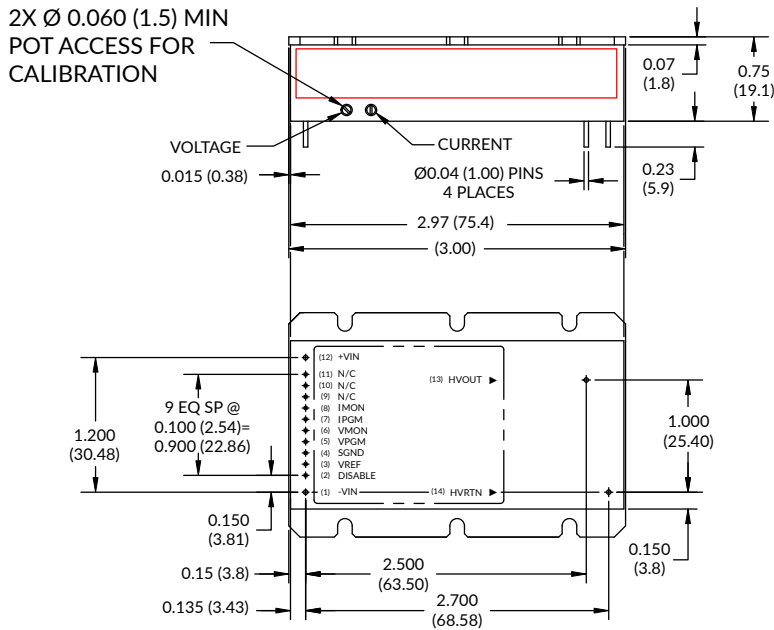

**Notes:**

1. Dimensions are in inches (mm).
2. Weight: 0.26lb (120g) approx.
3. Tolerance: X.XX±0.02 (0.51).
4. Pin Tolerance: ±0.005 (0.127).

## Mechanical Details

Optional

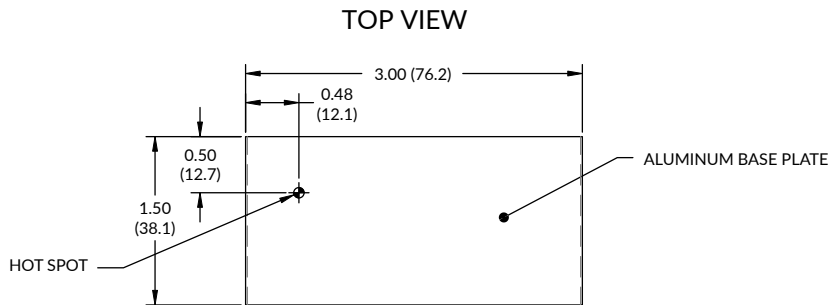

## RECOMMENDED PCB LAYOUT TOP VIEW

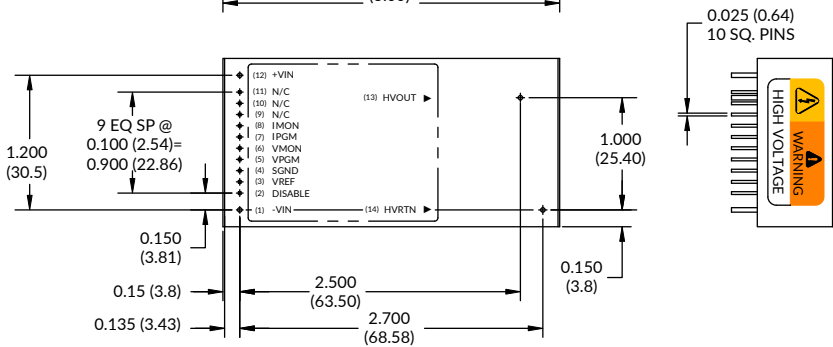
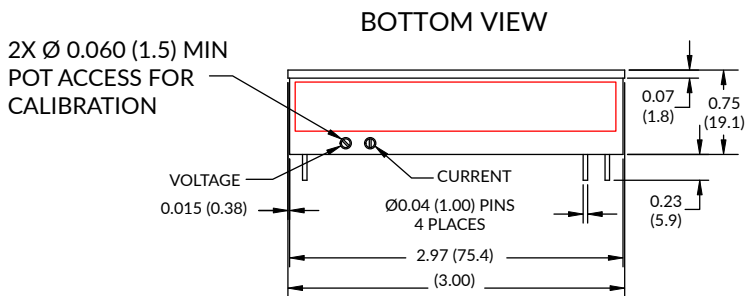
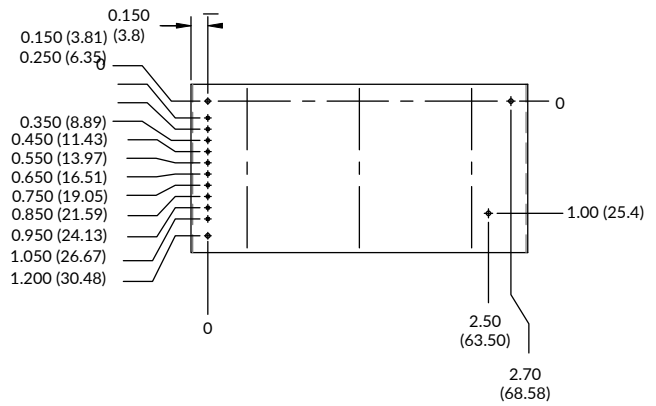

### Notes:

1. Dimensions are in inches (mm).
2. Weight: 0.26lb (120g) approx.
3. Tolerance: X.XX±0.02 (0.51).
4. Pin Tolerance: ±0.005 (0.127).

Application Notes

### Vref programming

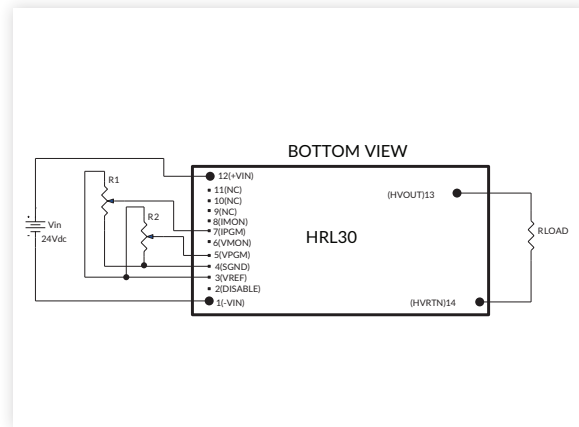

### Startup rise time Vout vs Vpgm

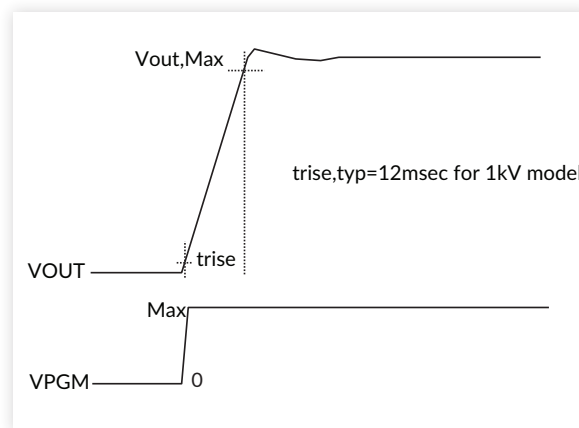

### V/I rectangular characteristics

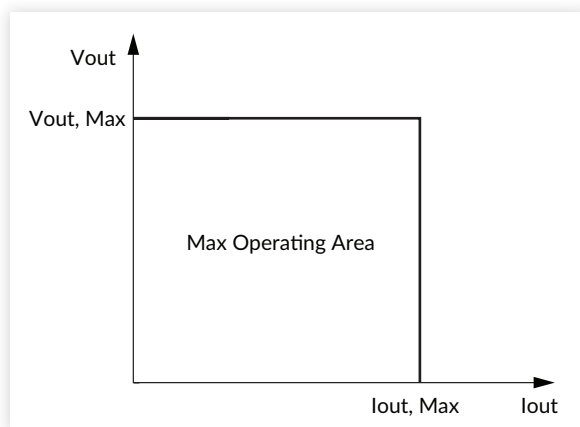

### V/I programming linearity

