

信昌電子陶瓷股份有限公司
Prosperity Dielectrics Co., Ltd.

No.566-1, Gaoshi Rd., Lujhu, Yangmei Dist., Taoyuan City 32668, Taiwan, R.O.C.
Tel. : +886-3-4753355 Fax : +886-3-4854959

SPECIFICATION FOR APPROVAL

DATE :

CUSTOMER : _____

PART NAME : Thick Flim Power Surge Chip Resistor

CUSTOMER'S DWG. NO. : _____

CUSTOMER'S PART NO. : _____

PDC PART NO. : **FPS SERIES APPROVED**

DESCRIPTION. : _____

ACTION	"V"	CUSTOMER'S SIGNATURE	NOTE
RESULT			
FULL APPROVED			
CONDITIONAL APPROVED			
REJECTED			

OUR ACTION	SIGNATURE
PREPARED By	<i>Jenny Tseng</i>
CHECKED By	<i>Tony Chou</i>
APPROVED By	<i>Byron Tsai</i>

CUSTOMER SIGNATURE FOR ACCEPTANCE

1. Features	2
2. Applications.....	2
3. Dimension and construction	2
4. Power Derating Curve	3
5. Rating	3
6. Part Number	5
7. Resistance Marking / Soldering / Surge Performance	5
8. Reliability Performance.....	8
9. Packing	11
9.1 Peel Strength of Top Cover Tape.....	11
9.2 Tape Packaging Dimensions.....	11
9.3 Reel Dimensions.....	12
10. Storage / Handling	12
※. Appendix	13

1. Features

- High power rating to 2W and compact size.
- High reliability and high precision (1%).
- Suitable for withstanding surge voltage.
- Suitable for lead free soldering.
- Meet AEC-Q200, RoHS compliant & Halogen Free.

2. Applications

- Power supply.
- Automotive industry.
- Digital meter, Consumer electronics, M/B.
- LED Lighting.
- Industry control board.

3. Dimension and Construction

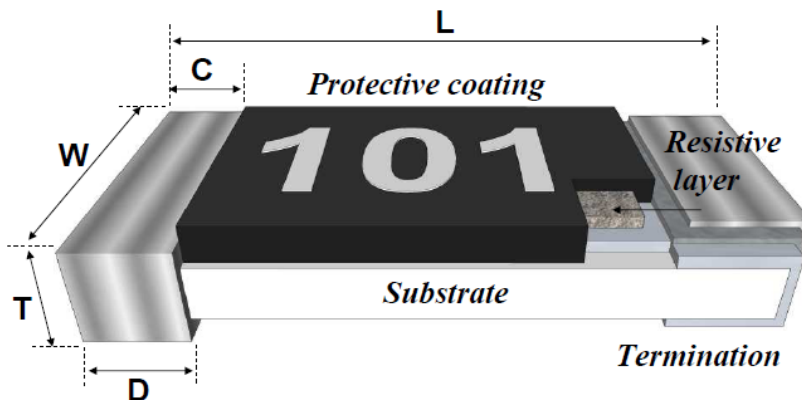

Unit : mm

Type	L	W	C	D	T
FPS03	1.60±0.10	0.80±0.10	0.30±0.20	0.30±0.20	0.45±0.10
FPS05	2.00±0.10	1.25±0.10	0.40±0.20	0.40±0.20	0.50±0.10
FPS06	3.10±0.10	1.60±0.10	0.50±0.25	0.50±0.25	0.55±0.10
FPS12	3.10±0.10	2.60±0.10	0.50±0.25	0.50±0.25	0.55±0.10
FPS20	5.00±0.20	2.50±0.20	0.65±0.25	0.60±0.25	0.60±0.10
FPS25	6.40±0.20	3.10±0.20	0.60±0.25	1.80±0.25	0.60±0.15

4. Power Derating Curve

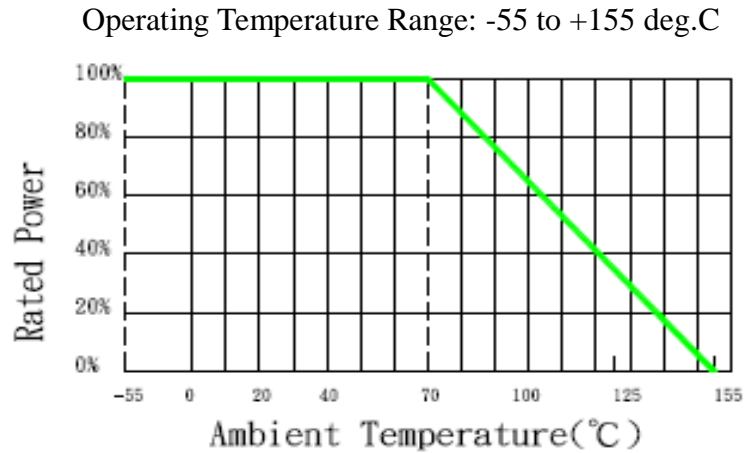

5. Rating

Resistor:

Type	Size	Power Rating at 70°C	Max. RCWV	Max. Overload Voltage	Resistance Tolerance	Temperature Coefficient (ppm/°C)	Resistance Range		Standard Resistance Values
							Min.	Max.	
FPS03	0603	1/8W	50V	100V	±1%(F)	±100ppm	10Ω	1MΩ	E96/E24
					±1%(F)	±200ppm	1Ω	9.76Ω	E96/E24
					±5%(J)	±200ppm	1Ω	1MΩ	E24
FPS05	0805	1/4W	150V	300V	±1%(F)	±100ppm	10Ω	1MΩ	E96/E24
					±1%(F)	±150ppm	1Ω	9.76Ω	E96/E24
					±1%(F)	<u>L Code</u> ±200ppm	1Ω	10Ω	E96/E24
					±5%(J)	±200ppm	1Ω	1MΩ	E24
FPS06	1206	1/2W	200V	400V	±1%(F)	±100ppm	1Ω	1MΩ	E96/E24
					±1%(F)	<u>L Code</u> ±200ppm	1Ω	10Ω	E96/E24
					±5%(J)	±200ppm	1Ω	1MΩ	E24

FPS series. (AEC-Q200) High-Power & Anti-Surge Thick-film Lead Free Chip Resistors

Type	Size	Power Rating at 70°C	Max. RCWV	Max. Overload Voltage	Resistance Tolerance	Temperature Coefficient (ppm/°C)	Resistance Range		Standard Resistance Values
							Min.	Max.	
FPS12	1210	1/2W	200V	400V	±1%(F)	±100ppm	1Ω	1MΩ	E96/E24
					±1%(F)	<u>L Code</u> ±200ppm	1Ω	10Ω	E96/E24
					±5%(J)	±200ppm	1Ω	1MΩ	E24
FPS20	2010	1W	200V	400V	±1%(F)	±100ppm	1Ω	1MΩ	E96/E24
					±1%(F)	<u>L Code</u> ±200ppm	1Ω	10Ω	E96/E24
					±5%(J)	±200ppm	1Ω	1MΩ	E24
FPS25	2512	2W	300V	600V	±1%(F)	±100ppm	1Ω	1MΩ	E96/E24
					±1%(F)	<u>L Code</u> ±200ppm	1Ω	10Ω	E96/E24
					±5%(J)	±200ppm	1Ω	1MΩ	E24

Note : $RCWV = (P \times R)^{1/2}$ or Max. RCWV listed above, whichever is lower.

RCWV : Working Voltage (V) , P : Rated Power (W) , R : Resistance Value (Ω)

Please consider the resistance variance from soldering pad/trace/amount, and keep the surface temperature do not exceed 105°C when full rated power applied.

Jumper:

Type	Size	Description	Max. Rated Current	Resistance
FPS03	0603	Zero Ohm · Jumper	≤ 2A	< 20mΩ
FPS05	0805	Zero Ohm · Jumper	≤ 4A	< 20mΩ
FPS06	1206	Zero Ohm · Jumper	≤ 4A	< 20mΩ
FPS12	1210	Zero Ohm · Jumper	≤ 4A	< 20mΩ
FPS20	2010	Zero Ohm · Jumper	≤ 6A	< 20mΩ
FPS25	2512	Zero Ohm · Jumper	≤ 6A	< 20mΩ

Note :

1. Max. rated current and resistance listed above, TCR is not applicable of jumper products.

6.Part Number

Type	Size	Tolerance	Packing	Watt	R Value (GM)	TCR	Control Code
FPS	03 :0603	F :±1%	Paper Tape : 0603.0805. 1206.1210 T : 5Kpcs V : 10Kpcs W : 20Kpcs Plastic Tape : 2010.2512 P : 4Kpcs X : 8Kpcs Y : 16Kpcs	=: As Rating Info	XXXX XXX 5%: 3 digits 1%: 4 digits	=: As Rating Info L:±200 1~10Ω Option	Null: Standard M : Meet AEC-Q200
	05 :0805	J :±5%					
	06 :1206						
	12 :1210						
	20 :2010						
	25 :2512						

Example :

FPS25FP-1004-M

→2512 size, tolerance 1%, plastic tape, 2W, 1 MΩ, Aec-Q200.

FPS06JT-104

→1206 size, tolerance 5%, paper tape, 1/2W, 100 KΩ, standard.

7.Marking/Soldering

Resistance value identify :

E24 ±5% : 3 Digits marking to identify the resistance value

0603/0805/1206/1210/2010/2512

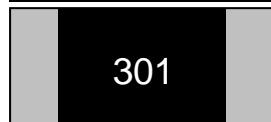

$$301 \rightarrow 30 \times 10^1 = 300\Omega$$

E24/E96 ±1% : 4 Digits marking to identify the resistance value

0805/1206/1210/2010/2512

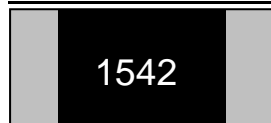

$$1542 \rightarrow 154 \times 10^2 = 15.4 \text{ K}\Omega$$

E24 ±1% : 3 Digits marking to identify the resistance value

0603



$$222 \rightarrow 22 \times 10^2 = 2.2 \text{ K}\Omega$$

E96 ±1% : 3 Digits marking to identify the resistance value

0603

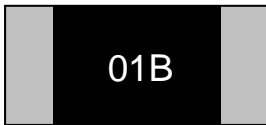

$$01B \rightarrow \text{Refer 0603 marking table} = 1 \text{ K}\Omega$$

Applicable Soldering Reference :

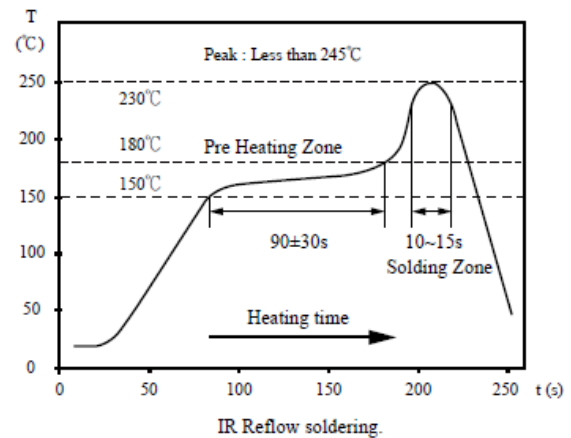
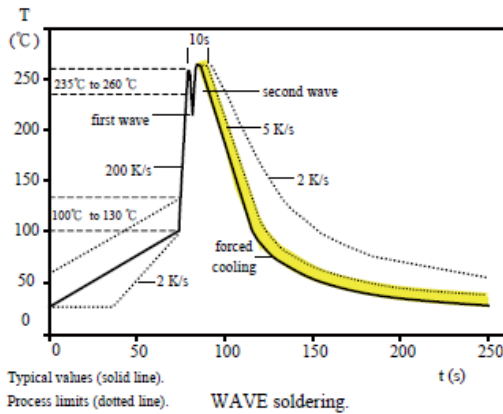

J-STD-020

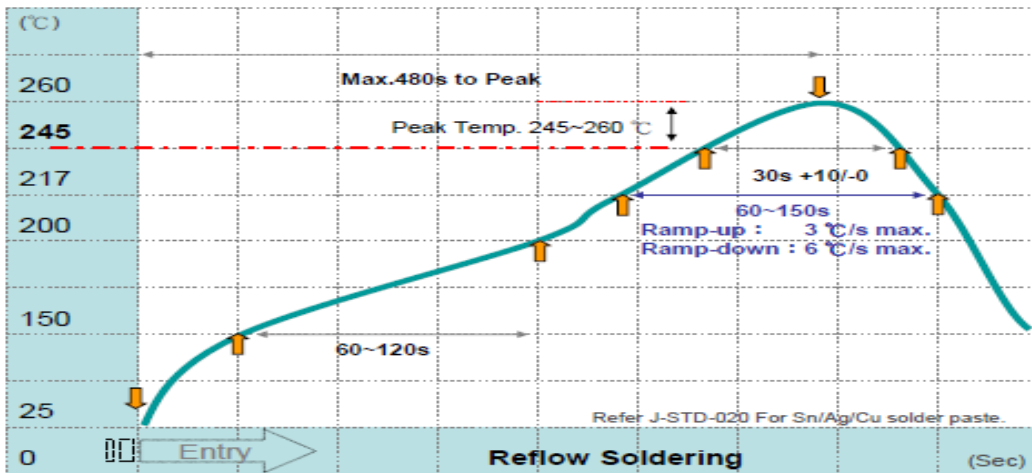

Recommend Solder Pad Dimensions :

Type	W	D	L
FPS03	0.90	1.00	3.00
FPS05	1.30	1.15	3.50
FPS06	1.80	1.30	4.70
FPS12	3.00	1.30	4.70
FPS20	3.00	1.50	6.80
FPS25	3.70	2.45	7.60

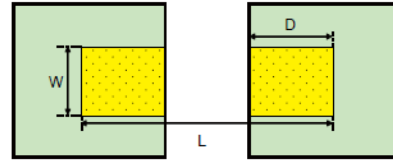

Unit:mm

Surge Performance :

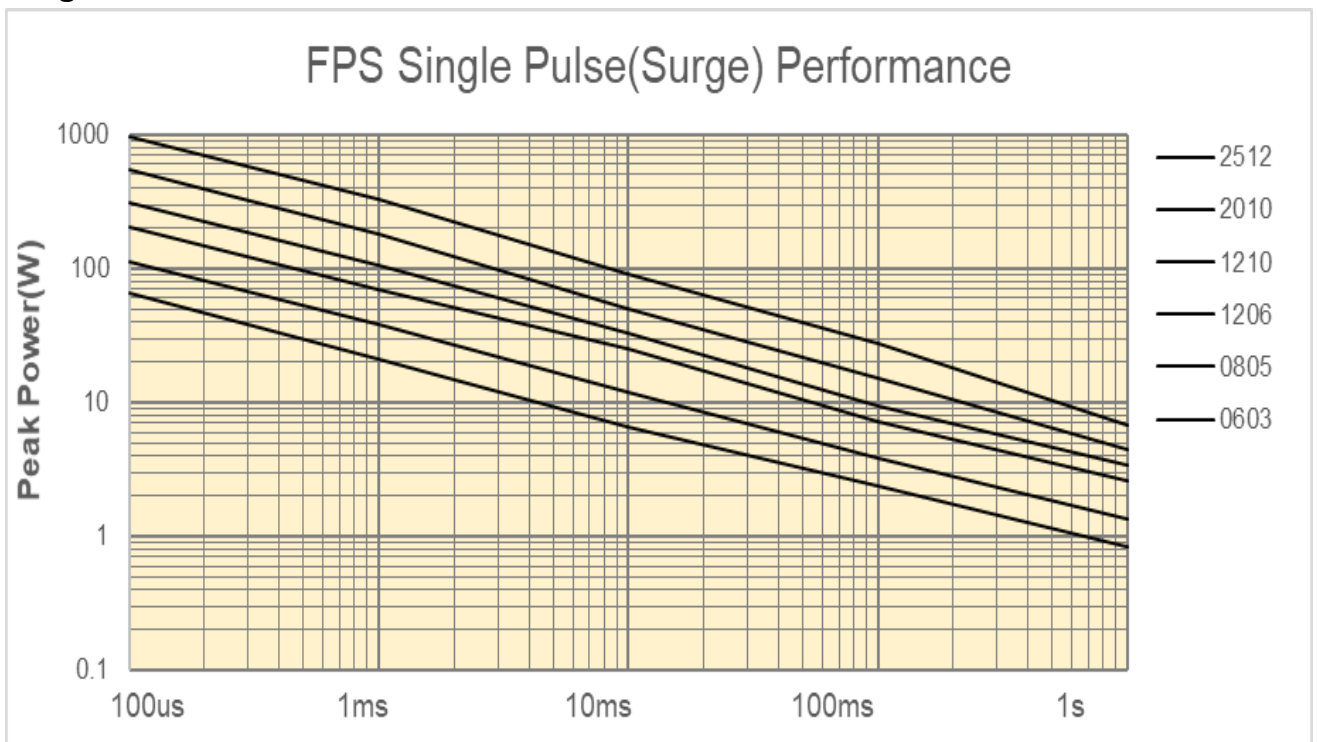

8. Reliability Performance (AEC-Q200)

Test Item	Specification	Test Method (AEC-Q200. IEC 60115)
*DC Resistance	F : $\pm 1\%$; J : $\pm 5\%$	AEC-Q200 TABLE 7.1 IEC 60115-1 / JIS C 5201-1 , Clause 4.5 Measure the resistance Value.
High Temperature Exposure (Storage)	J : $\Delta R \leq \pm(3\%+0.1\Omega)$ F : $\Delta R \leq \pm(1\%+0.05\Omega)$	AEC-Q200 TABLE 7.3 1000 hrs. @ T=125°C. Unpowered. Measurement at 24 \pm 2 hours after test conclusion.
*Temperature Cycling	J : $\Delta R \leq \pm(1\%+0.1\Omega)$ F : $\Delta R \leq \pm(0.5\%+0.05\Omega)$ No mechanical damage.	AEC-Q200 TABLE 7.4 1000 Cycles (-55°C to +125°C). Measurement at 24 \pm 2 hours after test conclusion.
Moisture Resistance	J : $\Delta R \leq \pm(1\%+0.1\Omega)$ F : $\Delta R \leq \pm(0.5\%+0.05\Omega)$	AEC-Q200 TABLE 7.6 Test 65°C/80~100%RH/10Cycles. Measurement at 24 \pm 2 hours after test conclusion. (t=24hrs/cycle).
Biased Humidity	J : $\Delta R \leq \pm(3\%+0.1\Omega)$ F : $\Delta R \leq \pm(1\%+0.05\Omega)$	AEC-Q200 TABLE 7.7 1000 hours 85°C/85%RH. 10% of operating power. Measurement at 24 \pm 2 hours after test conclusion.
Operational Life	J : $\Delta R \leq \pm(3\%+0.1\Omega)$ F : $\Delta R \leq \pm(1\%+0.05\Omega)$	AEC-Q200 TABLE 7.8 Test 1000hr @ TA=125°C at specified rated power. Measurement at 24 \pm 2 hours after test conclusion.
External Visual	No visual damage and refer PDC marking code.	AEC-Q200 TABLE 7.9 Inspect device construction, marking and workmanship.
Physical Dimension	Within the spec.	AEC-Q200 TABLE 7.10 Verify physical dimensions to the applicable device detail specification.
Mechanical Shock	Within product specification tolerance and no visible damage.	AEC-Q200 TABLE 7.13 Test Peak value:100g's,Wave:Hail-sine, Duration:6ms,Velocity:12.3ft/sec.

FPS series. (AEC-Q200) High-Power & Anti-Surge Thick-film Lead Free Chip Resistors

Vibration	No mechanical damage.	AEC-Q200 TABLE 7.14 5 g's for 20 min., 12 cycles each of 3 orientations. Test from 10-2000 Hz.
*Resistance to Solder Heat	J : $\Delta R \leq \pm(1\% + 0.1\Omega)$ F : $\Delta R \leq \pm(0.5\% + 0.05\Omega)$ No mechanical damage.	AEC-Q200 TABLE 7.15 Solder dipping @ 270°C±5°C for 10sec.±1sec.
Thermal Shock	J : $\Delta R \leq \pm(1\% + 0.1\Omega)$ F : $\Delta R \leq \pm(0.5\% + 0.05\Omega)$ No mechanical damage.	AEC-Q200 TABLE 7.16 -55 to 155°C/ dwell time 15min/ Max transfer time 20sec/ 300cycles.
ESD	$\Delta R \leq \pm(1\% + 0.1\Omega)$ No mechanical damage.	AEC-Q200-002 Test contact min. 1KV.
*Solder Ability	Over 95% of termination must be covered with solder.	AEC-Q200 TABLE 7.18 a) Baking 155°C 4H, dipping 235°C 5s b) Steam 1H, dipping 215°C 5s c) Steam 1H, dipping 260°C 7s
Flammability	Refer UL-94.	AEC-Q200 TABLE 7.20 UL-94 V-0 or V-1 are acceptable
*Board Flex	J : $\Delta R \leq \pm(1\% + 0.1\Omega)$ F : $\Delta R \leq \pm(0.5\% + 0.05\Omega)$ No mechanical damage.	AEC-Q200 TABLE 7.21 Bending 2mm 2512.2010.1210.1206, 3mm 0805.0603.
Terminal Strength	No mechanical damage	AEC-Q200 TABLE 7.22 Force 1 Kg for 60 seconds.
*Short Time Overload	J : $\Delta R \leq \pm(2\% + 0.1\Omega)$ F : $\Delta R \leq \pm(1\% + 0.05\Omega)$	IEC 60115-1, Clause 4.13 5 × Rated power for 5 seconds
*Load Life Humidity	J : $\Delta R \leq \pm(3\% + 0.1\Omega)$ F : $\Delta R \leq \pm(1\% + 0.05\Omega)$	IEC 60115-1, Clause 4.24 40±2°C with relative humidity 90% ~ 95% D.C. rated voltage for 1.5 hours ON 30 minutes OFF. Cycle repeated 1000 hours.

FPS series. (AEC-Q200)
High-Power & Anti-Surge
Thick-film Lead Free Chip Resistors

*Temperature Coefficient of Resistance (TCR)	Within the spec.	IEC 60115-1, Clause 4.8 $T_1 \quad T_2$ Test temperature : 25°C~ -55°C 25°C~ +155°C $TCR(ppm/^{\circ}C) = (R_2-R_1)/R_1 \times 1 / (T_2-T_1) \times 10^6$
*Load Life	J : $\Delta R \leq \pm(3\%+0.1\Omega)$ F : $\Delta R \leq \pm(1\%+0.05\Omega)$	IEC 60115-1, Clause 4.25 Rated voltage for 1.5 hours for followed by a pause 0.5 hour at 70±2°C. Cycle repeated 1000 hours.
*Insulation Resistance	Between termination and coating must over 1000MΩ	IEC 60115-1, Clause 4.6 Test voltage : 100±15V

* Normal test items for standard product.

9. PACKAGING

9.1 Peel Strength of Top Cover Tape

The peel speed shall be about 300 mm/min

The peel force of top cover tape shall between 0.1 to 0.7N

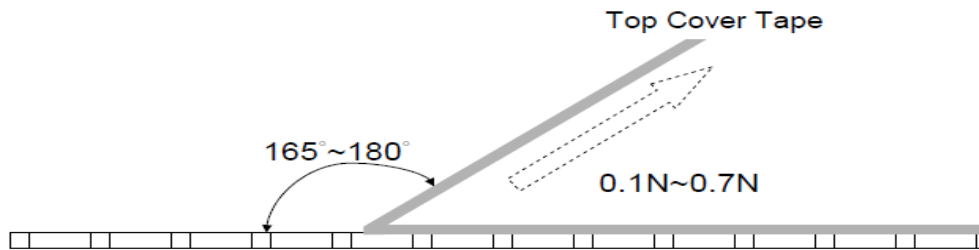

9.2 Tape Packaging Dimensions

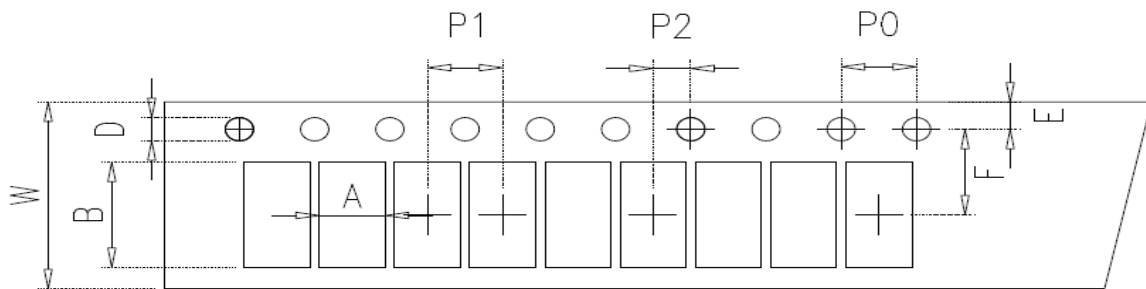

Size	A	B	W	F	E	P1	P2	P0	D	unit:mm
0603	1.10±0.20	1.90±0.20	8.00±0.30	3.50±0.05	1.75±0.10	4.00±0.10	2.00±0.05	4.00±0.10	1.50+0.10/-0	
0805	1.65±0.20	2.40±0.20	8.00±0.30	3.50±0.05	1.75±0.10	4.00±0.10	2.00±0.05	4.00±0.10	1.50+0.10/-0	
1206	2.00±0.20	3.60±0.20	8.00±0.30	3.50±0.05	1.75±0.10	4.00±0.10	2.00±0.05	4.00±0.10	1.50+0.10/-0	
1210	3.00±0.20	3.60±0.20	8.00±0.30	3.50±0.05	1.75±0.10	4.00±0.10	2.00±0.05	4.00±0.10	1.50+0.10/-0	
2010	2.80±0.20	5.50±0.20	12.00±0.30	5.50±0.05	1.75±0.10	4.00±0.10	2.00±0.05	4.00±0.10	1.50+0.10/-0	
2512	3.50±0.20	6.70±0.20	12.00±0.30	5.50±0.05	1.75±0.10	4.00±0.10	2.00±0.05	4.00±0.10	1.50+0.10/-0	

unit : mm

9.3 Reel Dimensions

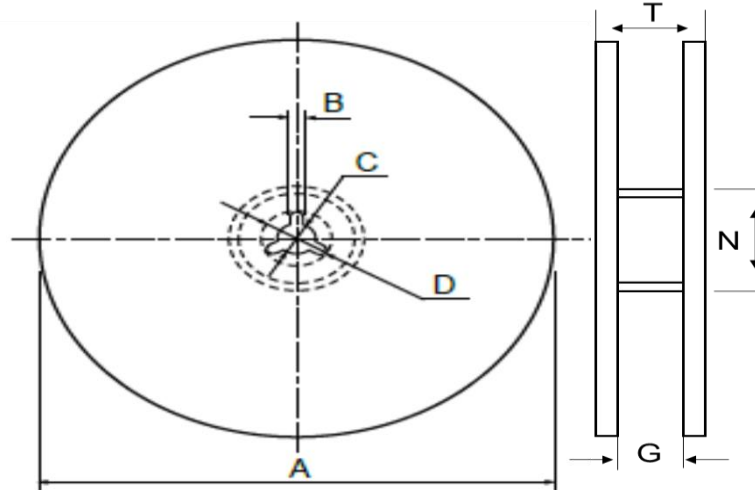

unit:mm

Size	Packaging Q'ty	A	N	C	D	B	G	T
0603	5kpcs/Reel	178.0±2.0	60.0±0.5	13.0±0.5	20(Min.)	2.0±0.5	10.0±1.5	14.9max.
0805	10kpcs/Reel	254.0±2.0	100.0±1.0	13.5±0.5	20(Min.)	2.0±0.5	10.0±1.5	14.9max.
1206	20kpcs/Reel	330.0±2.0	100.0±1.0	13.5±0.5	20(Min.)	2.0±0.5	10.0±1.5	14.9max.
2010	4kpcs/Reel	178.0±2.0	60.0±0.5	13.0±0.5	20(Min.)	2.0±0.5	13.8±1.5	16.7max.
2512	8kpcs/Reel	254.0±2.0	100.0±0.5	13.5±0.5	20(Min.)	2.0±0.5	13.8±1.5	20.0max.
	16kpcs/Reel	330.0±2.0	100.0±1.0	13.5±0.5	20(Min.)	2.0±0.5	13.8±1.5	20.0max.

10. Storage & Handling

... Products are recommended to be used up within one year as ensured shelf life.

Check solder ability in case shelf life extension is needed.

... To store products with following condition:

Temperature:5 to 40°C ; Humidity: 20 to 70% relative humidity.

Precaution for use :

The AEC-Q200 series resistors is mainly used on general automotive equipment without safety considerations.

Please contact our company in advanced if you intend to use resistor for designing the equipment which may

damage itself and the safety of third party. If necessary, please consider to add the protect circuit in devising

process and obtaining fully safety evaluation. The contents of the acknowledgment is only used for our parent

company, marketing subsidiaries and official marketing agents who purchase our products. Not applicable for the

other nonofficial channels.

Appendix

■ 0603 1% Marking Table (Table 1)

Code	E48	E96	Code	E48	E96	Code	E48	E96	Code	E48	E96
01	100	100	25	178	178	49	316	316	73	562	562
02		102	26		182	50		324	74		576
03	105	105	27	187	187	51	332	332	75	590	590
04		107	28		191	52		340	76		604
05	110	110	29	196	196	53	348	348	77	619	619
06		113	30		200	54		357	78		634
07	115	115	31	205	205	55	365	365	79	649	649
08		118	32		210	56		374	80		665
09	121	121	33	215	215	57	383	383	81	681	681
10		124	34		221	58		392	82		698
11	127	127	35	226	226	59	402	402	83	715	715
12		130	36		232	60		412	84		732
13	133	133	37	237	237	61	422	422	85	750	750
14		137	38		243	62		432	86		768
15	140	140	39	249	249	63	442	442	87	787	787
16		143	40		255	64		453	88		806
17	147	147	41	261	261	65	464	464	89	825	825
18		150	42		267	66		475	90		845
19	154	154	43	274	274	67	487	487	91	866	866
20		158	44		280	68		499	92		887
21	162	162	45	287	287	69	511	511	93	909	909
22		165	46		294	70		523	94		931
23	169	169	47	301	301	71	536	536	95	953	953
24		174	48		309	72		549	96		976

Code	A	B	C	D	E	F	G	H	X	Y	Z
Multiplier	10 ⁰	10 ¹	10 ²	10 ³	10 ⁴	10 ⁵	10 ⁶	10 ⁷	10 ⁻¹	10 ⁻²	10 ⁻³

※ All product specification and data are subject to change without notice.