

**Major Ratings and Characteristics**

Characteristics	403DMQ...	Units
$I_{F(AV)}$ Rectangular waveform	400	A
$V_{RRM}$	100	V
$I_{FSM}$ @tp = 5 $\mu$ s sine	25,500	A
$V_F$ @200Apk, $T_J=125^\circ\text{C}$ (per leg)	0.72	V
$T_J$ range	-55 to 175	$^\circ\text{C}$

**Description/ Features**

The 403DMQ100 center tap Schottky rectifier module series has been optimized for low reverse leakage at high temperature. The proprietary barrier technology allows for reliable operation up to 175  $^\circ\text{C}$  junction temperature. Typical applications are in high current switching power supplies, plating power supplies, UPS systems, converters, free-wheeling diodes, welding, and reverse battery protection.

- 175  $^\circ\text{C}$   $T_J$  operation
- Center tap module
- High purity, high temperature epoxy encapsulation for enhanced mechanical strength and moisture resistance
- Low forward voltage drop
- High frequency operation
- Guard ring for enhanced ruggedness and long term reliability

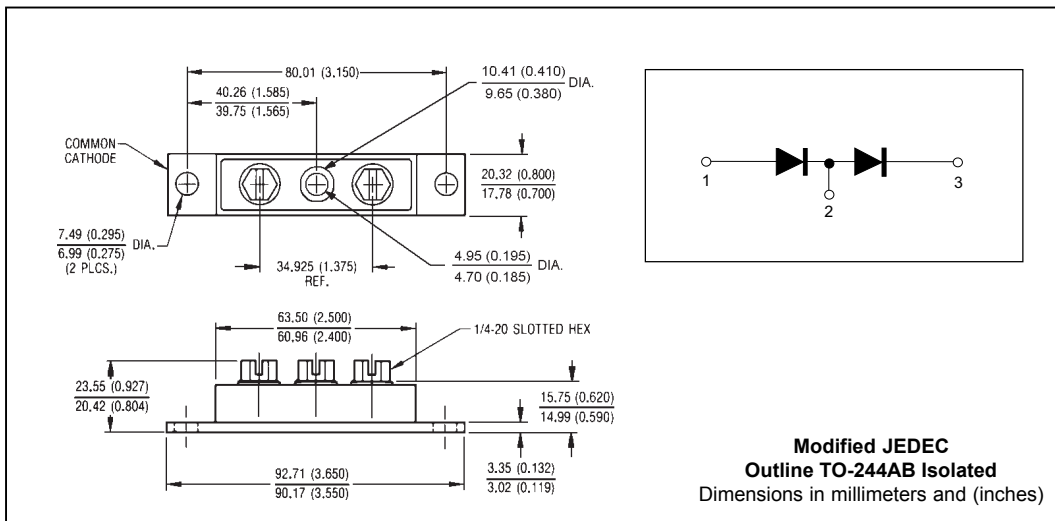

## Voltage Ratings

Parameters	403DMQ100
$V_R$ Max. DC Reverse Voltage (V)	100
$V_{RWM}$ Max. Working Peak Reverse Voltage (V)	

## Absolute Maximum Ratings

Parameters	403DMQ	Units	Conditions
$I_{F(AV)}$ Max. Average Forward Current (Per Leg)	400	A	50% duty cycle @ $T_C = 82^\circ\text{C}$ , rectangular wave form
$I_{FSM}$ Max. Peak One Cycle Non-Repetitive Surge Current (Per Leg)	25,500	A	5 $\mu\text{s}$ Sine or 3 $\mu\text{s}$ Rect. pulse 10ms Sine or 6ms Rect. pulse
	3,300		
$E_{AS}$ Non-Repetitive Avalanche Energy (Per Leg)	15	mJ	$T_J = 25^\circ\text{C}$ , $I_{AS} = 1$ Amps, $L = 30$ mH
$I_{AR}$ Repetitive Avalanche Current (Per Leg)	1	A	Current decaying linearly to zero in 1 $\mu\text{sec}$ Frequency limited by $T_J$ max. $V_A = 1.5 \times V_R$ typical

## Electrical Specifications

Parameters	403DMQ	Units	Conditions
$V_{FM}$ Max. Forward Voltage Drop (Per Leg) (1)	0.87	V	@ 200A
	1.06	V	@ 400A
	0.72	V	@ 200A
	0.86	V	@ 400A
$I_{RM}$ Max. Reverse Leakage Current (Per Leg) (1)	6	mA	$T_J = 25^\circ\text{C}$
	140	mA	$T_J = 125^\circ\text{C}$
$C_T$ Max. Junction Capacitance (Per Leg)	5500	pF	$V_R = 5V_{DC}$ , (test signal range 100Khz to 1Mhz) $25^\circ\text{C}$
$L_S$ Typical Series Inductance (Per Leg)	5.0	nH	From top of terminal hole to mounting plane
$dv/dt$ Max. Voltage Rate of Change (Rated $V_R$ )	10000	V/ $\mu\text{s}$	

(1) Pulse Width < 300 $\mu\text{s}$ , Duty Cycle < 2%

## Thermal-Mechanical Specifications

Parameters	403DMQ	Units	Conditions
$T_J$ Max. Junction Temperature Range	-55 to 175	$^\circ\text{C}$	
$T_{stg}$ Max. Storage Temperature Range	-55 to 175	$^\circ\text{C}$	
$R_{thJC}$ Max. Thermal Resistance Junction to Case (Per Leg)	0.4	$^\circ\text{C}/\text{W}$	DC operation
$R_{thJC}$ Max. Thermal Resistance Junction to Case (Per Package)	0.2	$^\circ\text{C}/\text{W}$	DC operation
$R_{thCS}$ Typical Thermal Resistance, Case to Heatsink	0.1	$^\circ\text{C}/\text{W}$	Mounting surface, smooth and greased
wt Approximate Weight	79 (2.80)	g (oz.)	
T Mounting Torque Base	Min.	24 (20)	Kg-cm (lbf-in)
	Max.	35 (30)	
	Mounting Torque Center Hole Typ.	13.5 (12)	
	Terminal Torque	Min.	
	Max.	46 (40)	
Case Style	TO - 244AB isolated doubler		Modified JEDEC

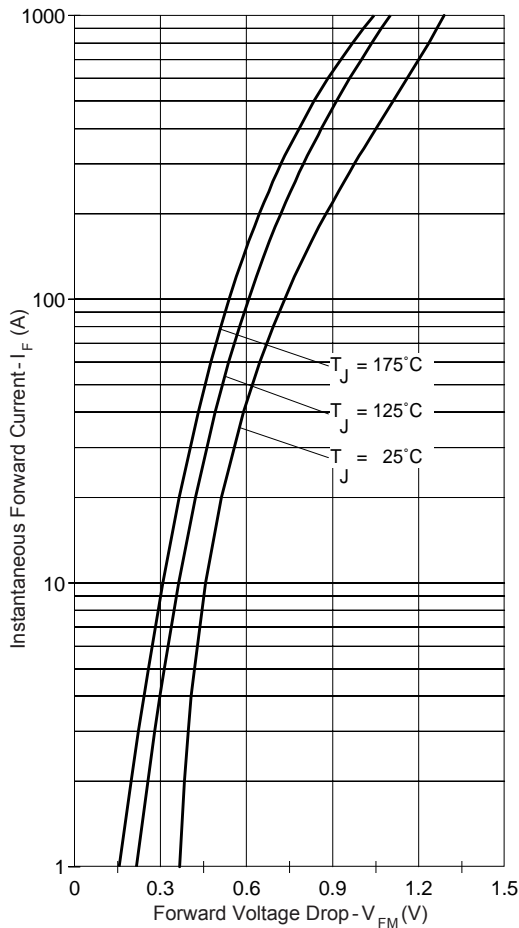

Fig. 1 - Max. Forward Voltage Drop Characteristics

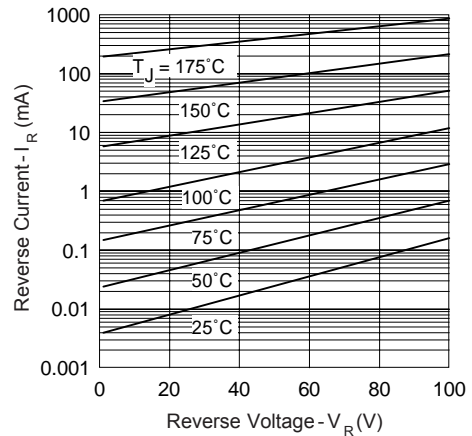

Fig. 2 - Typical Values Of Reverse Current Vs. Reverse Voltage

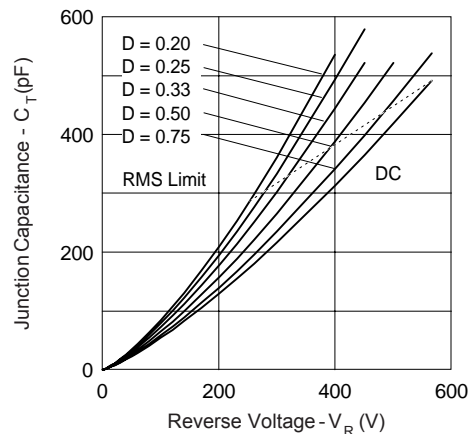

Fig. 3 - Typical Junction Capacitance Vs. Reverse Voltage

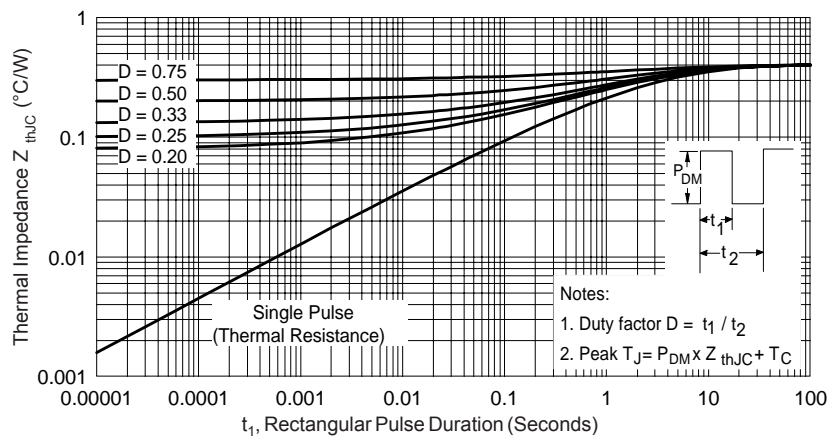

Fig. 4 - Max. Thermal Impedance  $Z_{thJC}$  Characteristics

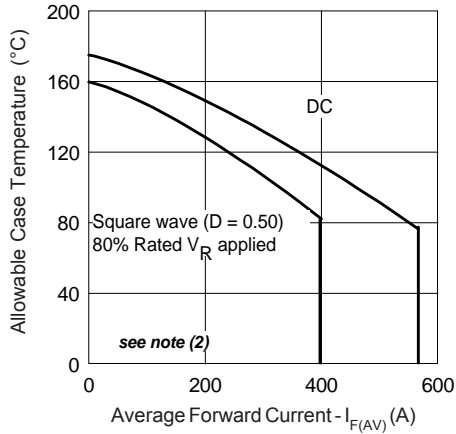

Fig. 5 - Max. Allowable Case Temperature Vs. Average Forward Current

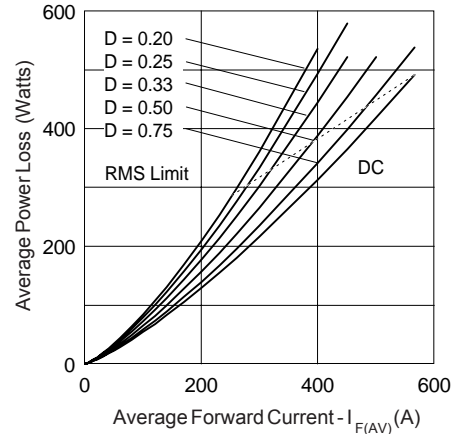

Fig. 6 - Forward Power Loss Characteristics

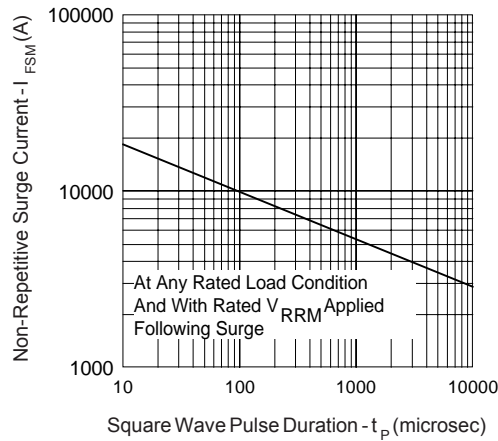

Fig. 7 - Max. Non-Repetitive Surge Current

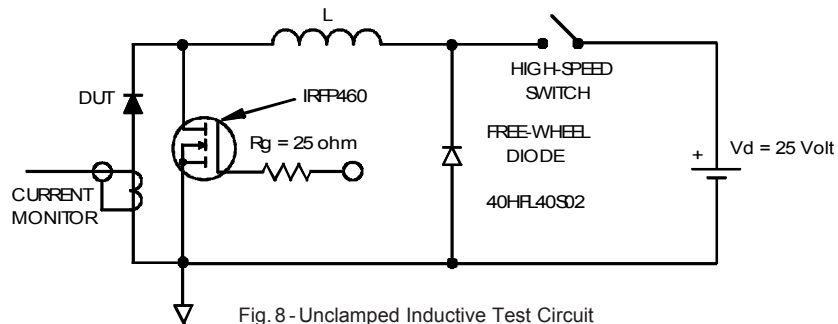

Fig. 8 - Unclamped Inductive Test Circuit

(2) Formula used:  $T_C = T_J - (P_d + P_{d_{REV}}) \times R_{thJC}$ ;

$P_d = \text{Forward Power Loss} = I_{F(AV)} \times V_{FM} @ (I_{F(AV)} / D)$  (see Fig. 6);

$P_{d_{REV}} = \text{Inverse Power Loss} = V_{R1} \times I_{R1} (1 - D)$ ;  $I_{R1} @ V_{R1} = 80\% \text{ rated } V_R$

Data and specifications subject to change without notice.  
This product has been designed and qualified for Industrial Level.  
Qualification Standards can be found on IR's Web site.

International  
**IOR** Rectifier

**IR WORLD HEADQUARTERS:** 233 Kansas St., El Segundo, California 90245, USA Tel: (310) 252-7105  
TAC Fax: (310) 252-7309

Visit us at [www.irf.com](http://www.irf.com) for sales contact information. 02/04