

# NCV8768

## LDO Regulator - Ultra Low $I_q$ , Window Watchdog, Enable, Reset

### 150 mA

The NCV8768 is 150 mA LDO regulator with integrated window watchdog and reset functions dedicated for microprocessor applications. Its robustness allows NCV8768 to be used in severe automotive environments. Ultra low quiescent current as low as 31  $\mu\text{A}$  typical makes it suitable for applications permanently connected to battery requiring ultra low quiescent current with or without load. The Enable function can be used for further decrease of quiescent current down to 1  $\mu\text{A}$ .

The NCV8768 contains protection functions as current limit and thermal shutdown.

#### Features

- Output Voltage Options: 5 V
- Output Voltage Accuracy:  $\pm 1.5\%$  ( $T_J = 25^\circ\text{C}$  to  $125^\circ\text{C}$ )
- Output Current up to 150 mA
- Ultra Low Quiescent Current: Typ 31  $\mu\text{A}$  (max 35  $\mu\text{A}$ )
- Very Low Dropout Voltage
- Enable Function
- Microprocessor Compatible Control Functions:
  - ♦ Reset with Adjustable Power-on Delay
  - ♦ Window Watchdog
- Wide Input Voltage Operation Range: up to 40 V
- Protection Features:
  - ♦ Current Limitation
  - ♦ Reverse Output Current
  - ♦ Thermal Shutdown
- These are Pb-Free Devices

#### Typical Applications

- Body Control Module
- Instruments and Clusters
- Occupant Protection and Comfort
- Powertrain

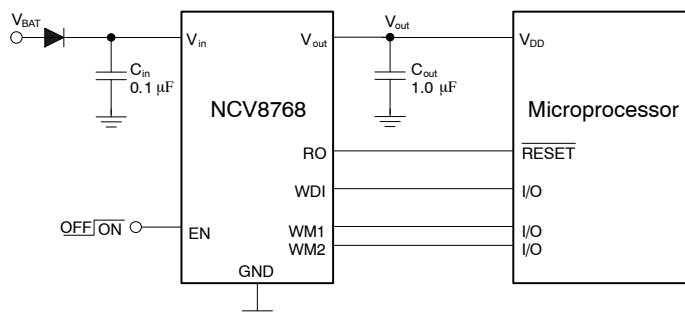
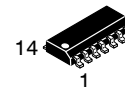

Figure 1. Application Schematic



ON Semiconductor®

<http://onsemi.com>



SOIC-14  
CASE 751A

#### MARKING DIAGRAMS

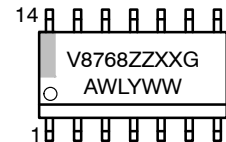

ZZ = Timing, Reset Threshold,  
Watchdog Control Options\*  
XX = Voltage Options  
= 5 V (XX = 50)  
A = Assembly Location  
WL = Wafer Lot  
Y = Year  
WW = Work Week  
G = Pb-Free Package

\*See APPLICATION INFORMATION Section.

#### ORDERING INFORMATION

See detailed ordering and shipping information in the package dimensions section on page 16 of this data sheet.

# NCV8768

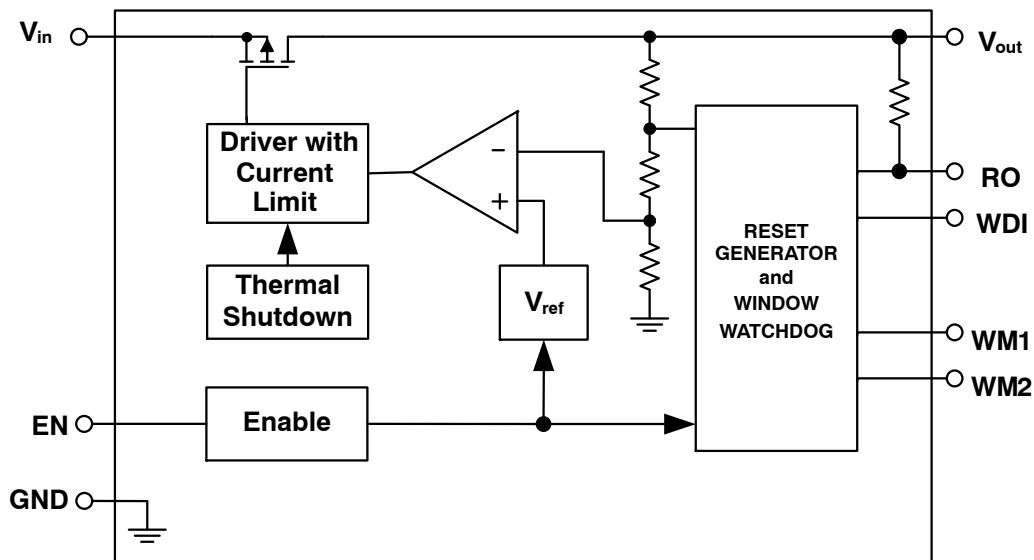
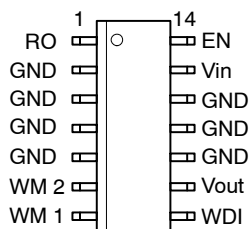

Figure 2. Simplified Block Diagram



SOIC-14

Figure 3. Pin Connections  
(Top View)

# NCV8768

## PIN FUNCTION DESCRIPTION

Pin No. SOIC-14	Pin Name	Description
1	RO	Reset Output. 30 k $\Omega$ internal Pull-Up resistor connected to V <sub>out</sub> . RO goes Low when V <sub>out</sub> drops by more than 7% from nominal.
2, 3, 4, 5, 10, 11, 12	GND	Power Supply Ground. – connect pin 2 and 3 to GND – connect pin 4–5 and 10–12 to heatsink area with GND potential
6	WM2	Watchdog Mode Bit 2; Watchdog and Reset mode selection. Connect to V <sub>out</sub> or GND.
7	WM1	Watchdog Mode Bit 1; Watchdog and Reset mode selection. Connect to V <sub>out</sub> or GND.
8	WDI	Watchdog Input; Trigger Input for Watchdog pulses. When not used, connect to V <sub>out</sub> or GND.
9	V <sub>out</sub>	Regulated Output Voltage. Connect 1.0 $\mu$ F capacitor with ESR < 100 $\Omega$ to ground.
13	V <sub>in</sub>	Positive Power Supply Input. Connect 0.1 $\mu$ F capacitor to ground.
14	EN	Enable Input; low level disables the IC.

**ABSOLUTE MAXIMUM RATINGS**

Rating	Symbol	Min	Max	Unit
Input Voltage (Note 1) DC Transient, t < 100 ms	$V_{in}$	-0.3 -	40 45	V
Input Current	$I_{in}$	-5	-	mA
Output Voltage (Note 2)	$V_{out}$	-0.3	5.5	V
Output Current	$I_{out}$	-3	Current Limited	mA
Enable Input Voltage Range DC Transient, t < 100 ms	$V_{EN}$	-0.3 -	40 45	V
Enable Input Current Range	$I_{EN}$	-1	1	mA
Reset Output Voltage (Note 3)	$V_{RO}$	-0.3	5.5	V
Reset Output Current	$I_{RO}$	-3	3	mA
Watchdog Input Voltage	$V_{WDI}$	-0.3	5.5	V
Watchdog Mode 1 Voltage	$V_{WM1}$	-0.3	5.5	V
Watchdog Mode 1 Current	$I_{WM1}$	-5	5	mA
Watchdog Mode 2 Voltage	$V_{WM2}$	-0.3	5.5	V
Watchdog Mode 2 Current	$I_{WM2}$	-5	5	mA
Junction Temperature	$T_J$	-40	150	°C
Storage Temperature	TSTG	-55	150	°C

Stresses exceeding Maximum Ratings may damage the device. Maximum Ratings are stress ratings only. Functional operation above the Recommended Operating Conditions is not implied. Extended exposure to stresses above the Recommended Operating Conditions may affect device reliability.

1. Refer to ELECTRICAL CHARACTERISTICS and APPLICATION INFORMATION for Safe Operating Area.
2. The Output voltage must not exceed the Input voltage.
3. The Reset Output voltage must not exceed the Output voltage.

**ESD CAPABILITY** (Note 4)

Rating	Symbol	Min	Max	Unit
ESD Capability, Human Body Model	$ESD_{HBM}$	-2	2	kV
ESD Capability, Machine Model	$ESD_{MM}$	-200	200	V

4. This device series incorporates ESD protection and is tested by the following methods:  
ESD Human Body Model tested per AEC-Q100-002 (EIA/JESD22-A114)  
ESD Machine Model tested per AEC-Q100-003 (EIA/JESD22-A115)

**LEAD SOLDERING TEMPERATURE AND MSL** (Note 5)

Rating	Symbol	Min	Max	Unit
Moisture Sensitivity Level	MSL		1	-
Lead Temperature Soldering Reflow (SMD Styles Only), Pb-Free Versions (Note 5)	$T_{SLD}$	-	265 peak	°C

5. For information, please refer to our Soldering and Mounting Techniques Reference Manual, SOLDERRM/D

**THERMAL CHARACTERISTICS** (Note 6)

Rating	Symbol	Value	Unit
Thermal Characteristics, SOIC-14 (Note 6)			°C/W
Thermal Resistance, Junction-to-Air (Note 7)	$R_{\theta JA}$	95	
Thermal Reference, Junction-to-Lead4 (Note 7)	$R_{\Psi JL}$	18.2	

6. Refer to ELECTRICAL CHARACTERISTICS and APPLICATION INFORMATION for Safe Operating Area.  
 7. Values based on copper area of 645 mm<sup>2</sup> (or 1 in<sup>2</sup>) of 1 oz copper thickness and FR4 PCB substrate.

**RECOMMENDED OPERATING RANGES** (Note 8)

Rating	Symbol	Min	Max	Unit
Input Voltage (Note 9)	$V_{in}$	4.5	40	V
Junction Temperature	$T_J$	-40	150	°C

8. Refer to ELECTRICAL CHARACTERISTICS and APPLICATION INFORMATION for Safe Operating Area.  
 9. Minimum  $V_{in} = 4.5$  V or ( $V_{out} + V_{DO}$ ), whichever is higher.

**ELECTRICAL CHARACTERISTICS**

$V_{in} = 13.2$  V,  $C_{in} = 0.1$  μF,  $C_{out} = 1.0$  μF, for typical values  $T_J = 25^\circ\text{C}$ , for min/max values  $T_J = -40^\circ\text{C}$  to  $150^\circ\text{C}$ ; unless otherwise noted. (Notes 10 and 11)

Parameter	Test Conditions	Symbol	Min	Typ	Max	Unit
-----------	-----------------	--------	-----	-----	-----	------

**REGULATOR OUTPUT**

Output Voltage (Accuracy %)	$T_J = 25^\circ\text{C}$ to $125^\circ\text{C}$ $V_{in} = 5.5$ V to 16 V, $I_{out} = 0.1$ mA to 100 mA	$V_{out}$	4.925 (-1.5%)	5.0	5.075 (+1.5%)	V
Output Voltage (Accuracy %)	$V_{in} = 5.55$ V to 40 V, $I_{out} = 0.1$ mA to 100 mA $V_{in} = 5.7$ V to 16 V, $I_{out} = 0.1$ mA to 150 mA	$V_{out}$	4.9 4.9 (-2%)	5.0 5.0	5.1 5.1 (+2%)	V
Output Voltage (Accuracy %)	$T_J = -40^\circ\text{C}$ to $125^\circ\text{C}$ $V_{in} = 5.5$ V to 28 V, $I_{out} = 0$ mA	$V_{out}$	4.9 (-2%)	5.0	5.1 (+2%)	V
Line Regulation	$V_{in} = 5.5$ V to 28 V, $I_{out} = 5$ mA	$Reg_{line}$	-20	0	20	mV
Load Regulation	$I_{out} = 0.1$ mA to 150 mA	$Reg_{load}$	-30	10	30	mV
Dropout Voltage (Note 12)	$I_{out} = 100$ mA $I_{out} = 150$ mA	$V_{DO}$	-	225 300	450 600	mV
Output Capacitor for Stability (Note 13)	$I_{out} = 0$ mA to 150 mA	$C_{out}$ ESR	1.0 -	- -	- 100	μF Ω

**Disable and Quiescent Current**

Disable Current	$V_{EN} = 0$ V, $T_J < 85^\circ\text{C}$	$I_{DIS}$	-	-	1	μA
Quiescent Current ( $I_q = I_{in} - I_{out}$ )	$I_{out} = 100$ μA, $T_J = 25^\circ\text{C}$ $I_{out} = 100$ μA, $T_J \leq 125^\circ\text{C}$	$I_q$	-	31 -	35 36	μA

**Current Limit Protection**

Current Limit	$V_{out} = 0.96 \times V_{out\_nom}$	$I_{LIM}$	205	-	525	mA
Short Circuit Current Limit	$V_{out} = 0$ V	$I_{SC}$	205	-	525	mA

**Reverse Output Current Protection**

Reverse Output Current Protection	$V_{EN} = 0$ V, $I_{out} = -1$ mA	$V_{out\_rev}$	-	2	5.5	V
-----------------------------------	-----------------------------------	----------------	---	---	-----	---

**PSRR**

Power Supply Ripple Rejection (Note 13)	$f = 100$ Hz, $0.5V_{pp}$	PSRR	-	60	-	dB
---	---------------------------	------	---	----	---	----

10. Refer to ABSOLUTE MAXIMUM RATINGS and APPLICATION INFORMATION for Safe Operating Area.  
 11. Performance guaranteed over the indicated operating temperature range by design and/or characterization tested at  $T_A \approx T_J$ . Low duty cycle pulse techniques are used during testing to maintain the junction temperature as close to ambient as possible.  
 12. Measured when output voltage falls 100 mV below the regulated voltage at  $V_{in} = 13.2$  V.  
 13. Values based on design and/or characterization.  
 14. Recommended for typical trigger time.  $T_{WD} = t_{CW} + 1/2 * t_{OW}$

**ELECTRICAL CHARACTERISTICS**

$V_{in} = 13.2\text{ V}$ ,  $C_{in} = 0.1\ \mu\text{F}$ ,  $C_{out} = 1.0\ \mu\text{F}$ , for typical values  $T_J = 25^\circ\text{C}$ , for min/max values  $T_J = -40^\circ\text{C}$  to  $150^\circ\text{C}$ ; unless otherwise noted. (Notes 10 and 11)

Parameter	Test Conditions	Symbol	Min	Typ	Max	Unit
-----------	-----------------	--------	-----	-----	-----	------

**Enable Thresholds**

Enable Input Threshold Voltage Logic High Logic Low		$V_{th(EN)}$	3 -	- -	- 0.8	V
Enable Input Current Logic High Logic Low	$V_{EN} = 5\text{ V}$ $V_{EN} = 0\text{ V}$ , $T_J < 85^\circ\text{C}$	$I_{EN\_ON}$ $I_{EN\_OFF}$	- -	3 0.5	5 1	$\mu\text{A}$

**Window Watchdog**

Watchdog Mode Bit 1 Threshold Voltage Voltage Increasing, Logic High Voltage Decreasing, Logic Low		$V_{WM1,H}$ $V_{WM1,L}$	- 0.8	- -	4.0 -	V
Watchdog Mode Bit 2 Threshold Voltage Voltage Increasing, Logic High Voltage Decreasing, Logic Low		$V_{WM2,H}$ $V_{WM2,L}$	- 0.8	- -	4.0 -	V
Watchdog Input WDI Threshold Voltage Voltage Increasing, Logic High Voltage Decreasing, Logic Low		$V_{WDI,H}$ $V_{WDI,L}$	- 0.8	- -	4.0 -	V
Watchdog Input WDI Current Logic High Logic Low	$V_{WDI,H} = 5\text{ V}$ $V_{WDI,L} = 0\text{ V}$ , $T_J < 85^\circ\text{C}$	$I_{WDI,H}$ $I_{WDI,L}$	- -	3 0.5	4 1	$\mu\text{A}$
Watchdog Sampling Time	Fast: WM2 = L Slow: WM1 = L AND WM2 = H	$t_{sam}$	0.4 0.8	0.5 1.0	0.6 1.2	ms
Ignore Window Time	Fast: WM2 = L Slow: WM1 = L AND WM2 = H	$t_{iw}$	25.6 51.2	32.0 64.0	38.4 76.8	ms
Open Window Time	Fast: WM2 = L Slow: WM1 = L AND WM2 = H	$t_{ow}$	25.6 51.2	32.0 64.0	38.4 76.8	ms
Closed Window Time	Fast: WM2 = L Slow: WM1 = L AND WM2 = H	$t_{cw}$	25.6 51.2	32.0 64.0	38.4 76.8	ms
Window Watchdog Trigger Time (Note 14)	Fast: WM2 = L Slow: WM1 = L AND WM2 = H	$t_{wd}$	- -	48 96	- -	ms
Watchdog Deactivation Current Threshold	$I_{out}$ decreasing $V_{in} > 5.5\text{ V}$	$I_{out\_WD\_OFF}$	0.5	-	-	mA
Watchdog Activating Current Threshold	$I_{out}$ increasing $V_{in} > 5.5\text{ V}$	$I_{out\_WD\_ON}$	-	2	5	mA

**Reset Output RO**

Output Voltage Reset Threshold	$V_{out}$ decreasing $V_{in} > 5.5\text{ V}$	$V_{RT}$	90	93	96	% $V_{out}$
Reset Hysteresis		$V_{RH}$	-	2.0	-	% $V_{out}$
Maximum Reset Sink Current	$V_{out} = 4.5\text{ V}$ , $V_{RO} = 0.25\text{ V}$	$I_{Romax}$	1.75	-	-	mA
Reset Output Low Voltage	$V_{out} > 1\text{ V}$ , $I_{RO} < 200\ \mu\text{A}$	$V_{ROL}$	-	0.15	0.25	V
Reset Output High Voltage		$V_{ROH}$	4.5	-	-	V
Integrated Reset Pull Up Resistor		$R_{RO}$	15	30	50	k $\Omega$
Reset Delay Time	Fast: WM1 = L AND WM2 = L Slow: WM1 = H OR (WM1 = L AND WM2 = H)	$t_{RD}$	12.8 25.6	16 32	19.2 38.4	ms
Reset Reaction Time (See Figure 24)		$t_{RR}$	16	25	38	$\mu\text{s}$

10. Refer to ABSOLUTE MAXIMUM RATINGS and APPLICATION INFORMATION for Safe Operating Area.

11. Performance guaranteed over the indicated operating temperature range by design and/or characterization tested at  $T_A \approx T_J$ . Low duty cycle pulse techniques are used during testing to maintain the junction temperature as close to ambient as possible.

12. Measured when output voltage falls 100 mV below the regulated voltage at  $V_{in} = 13.2\text{ V}$ .

13. Values based on design and/or characterization.

14. Recommended for typical trigger time.  $T_{WD} = t_{CW} + 1/2 * t_{OW}$

# NCV8768

## ELECTRICAL CHARACTERISTICS

$V_{in} = 13.2\text{ V}$ ,  $C_{in} = 0.1\ \mu\text{F}$ ,  $C_{out} = 1.0\ \mu\text{F}$ , for typical values  $T_J = 25^\circ\text{C}$ , for min/max values  $T_J = -40^\circ\text{C}$  to  $150^\circ\text{C}$ ; unless otherwise noted.  
(Notes 10 and 11)

Parameter	Test Conditions	Symbol	Min	Typ	Max	Unit
-----------	-----------------	--------	-----	-----	-----	------

### THERMAL SHUTDOWN

Thermal Shutdown Temperature (Note 13)		$T_{SD}$	150	175	195	$^\circ\text{C}$
Thermal Shutdown Hysteresis (Note 13)		$T_{SH}$	-	25	-	$^\circ\text{C}$

10. Refer to ABSOLUTE MAXIMUM RATINGS and APPLICATION INFORMATION for Safe Operating Area.

11. Performance guaranteed over the indicated operating temperature range by design and/or characterization tested at  $T_A \approx T_J$ . Low duty cycle pulse techniques are used during testing to maintain the junction temperature as close to ambient as possible.

12. Measured when output voltage falls 100 mV below the regulated voltage at  $V_{in} = 13.2\text{ V}$ .

13. Values based on design and/or characterization.

14. Recommended for typical trigger time.  $T_{WD} = t_{CW} + 1/2 * t_{OW}$

TYPICAL CHARACTERISTICS

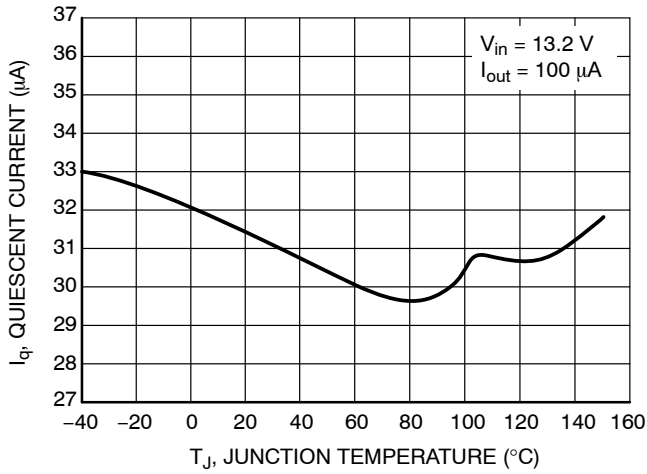

Figure 4. Quiescent Current vs Temperature

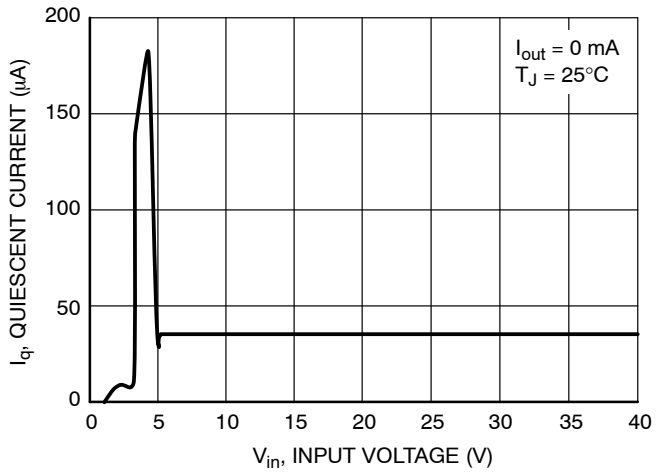

Figure 5. Quiescent Current vs Input Voltage

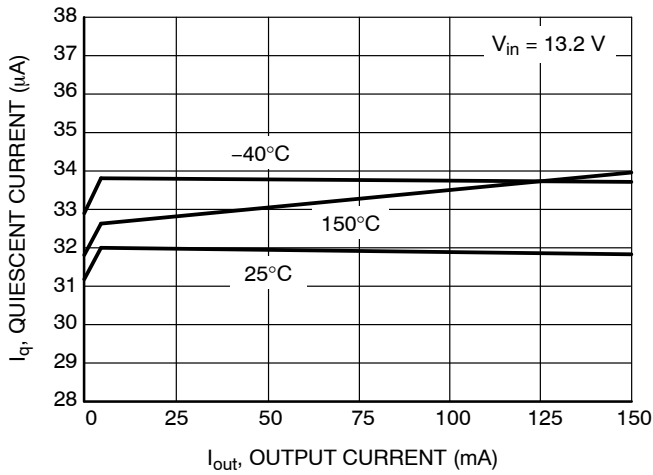

Figure 6. Quiescent Current vs Output Current

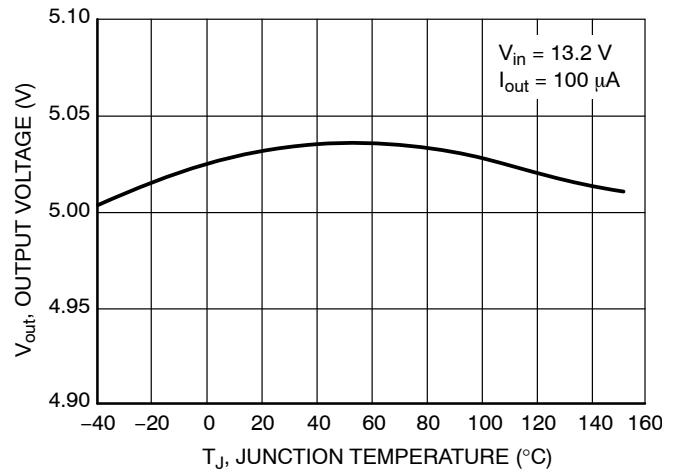

Figure 7. Output Voltage vs Temperature

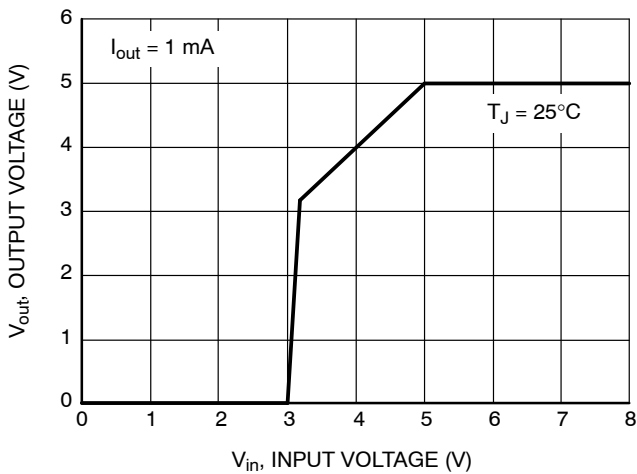

Figure 8. Output Voltage vs Input Voltage

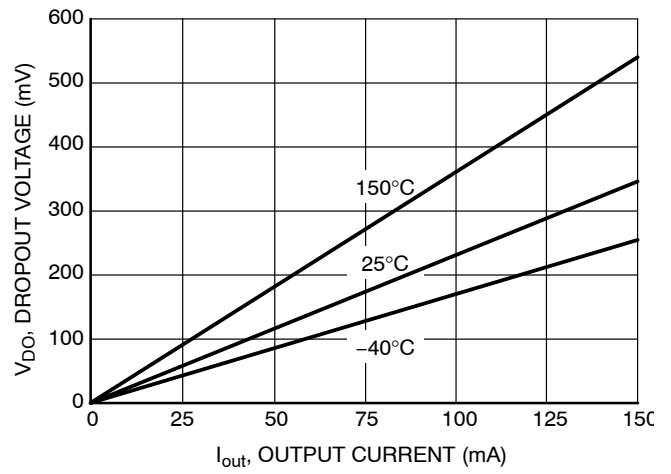

Figure 9. Dropout Voltage vs Output Current



TYPICAL CHARACTERISTICS

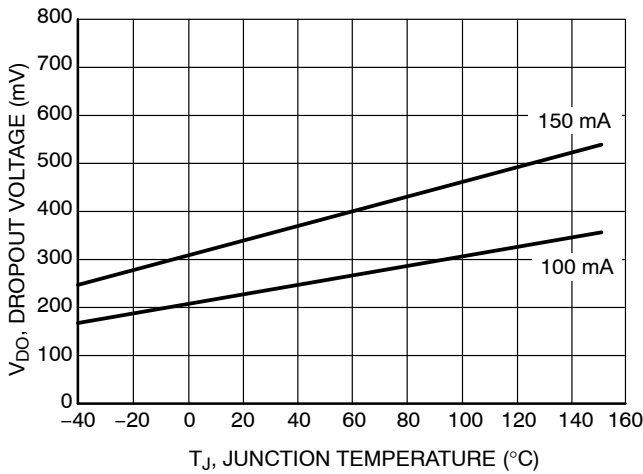

Figure 10. Dropout vs Temperature

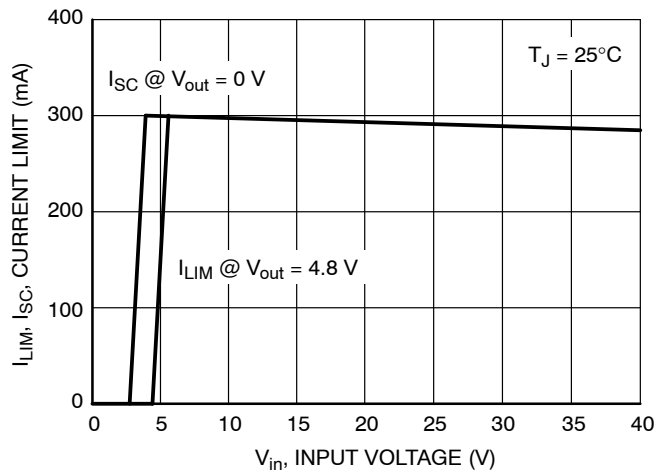

Figure 11. Current Limit vs. Input Voltage

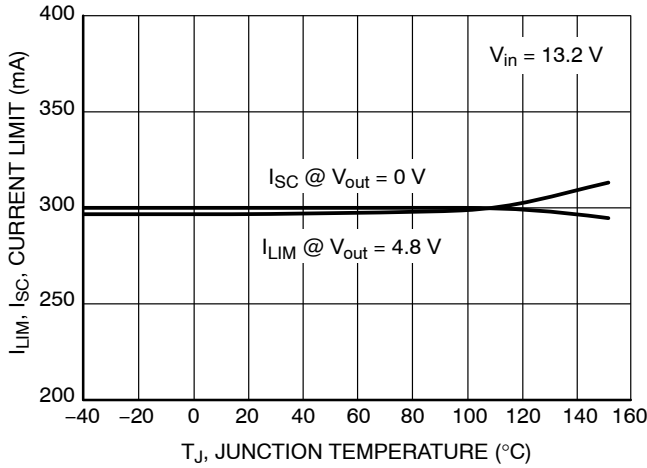

Figure 12. Current Limit vs. Temperature

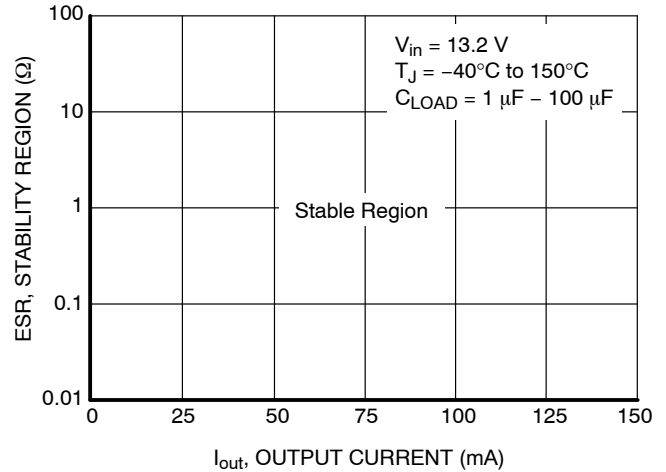

Figure 13.  $C_{out}$  ESR Stability Region vs Output Current

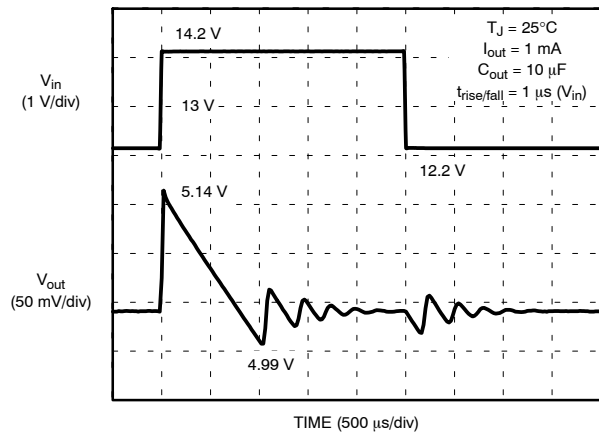

Figure 14. Line Transients

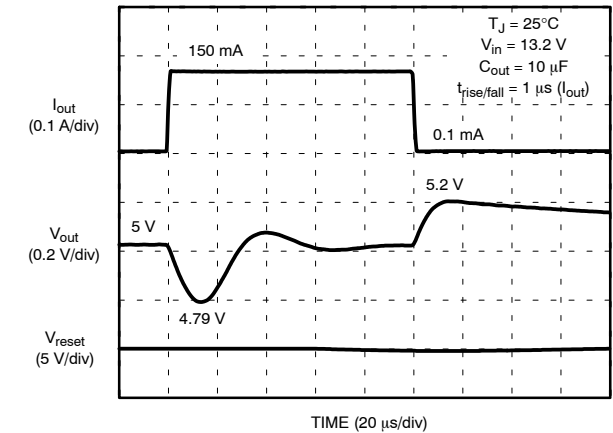

Figure 15. Load Transients

TYPICAL CHARACTERISTICS

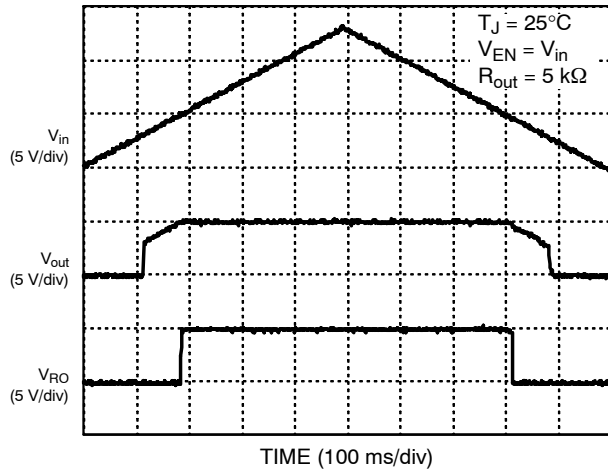

Figure 16. Power Up/Down Response

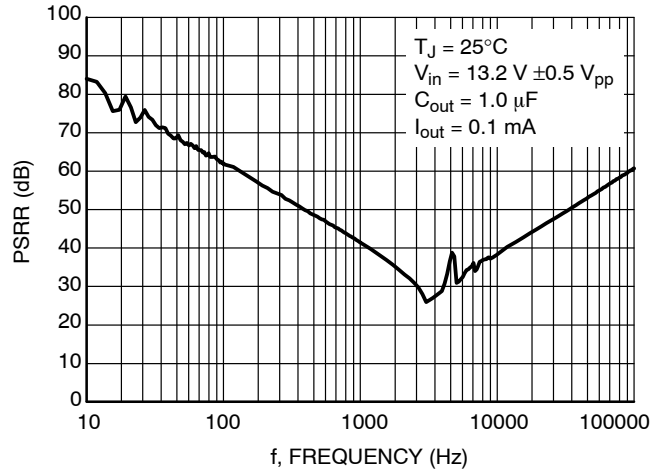

Figure 17. PSRR vs. Frequency

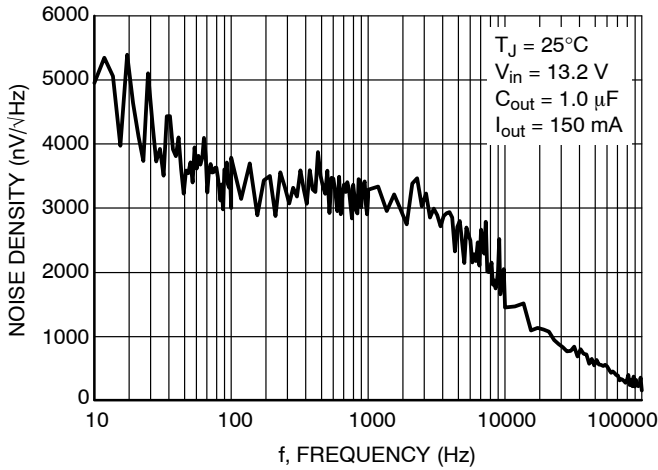

Figure 18. Noise vs. Frequency

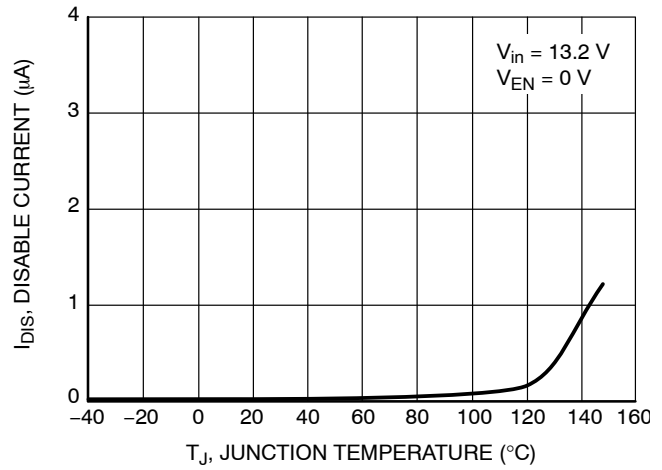

Figure 19. Disable Current vs. Temperature

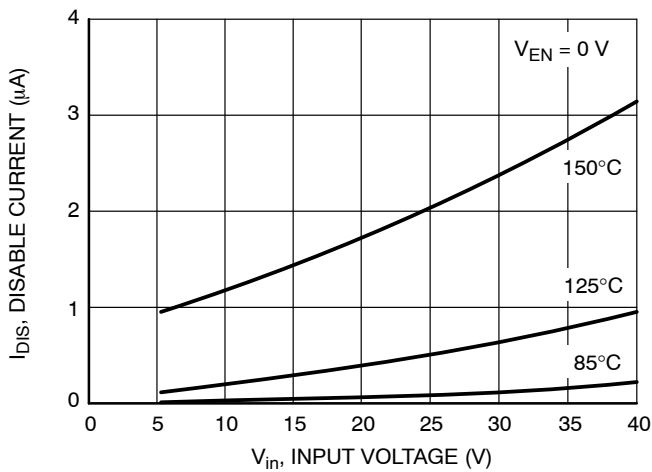

Figure 20. Disable Current vs. Input Voltage

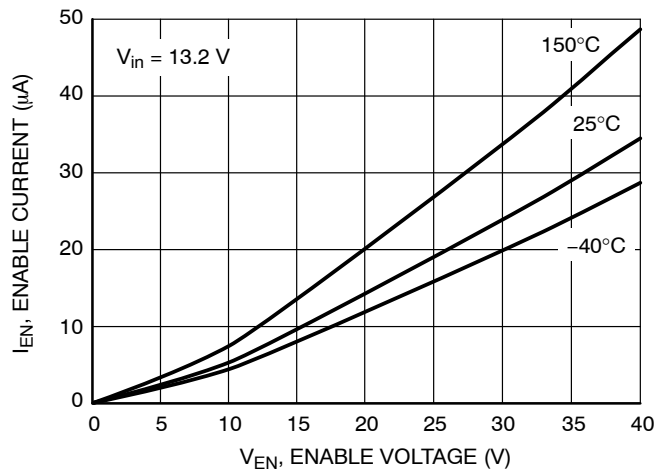

Figure 21. Enable Current vs. Enable Voltage

TYPICAL CHARACTERISTICS

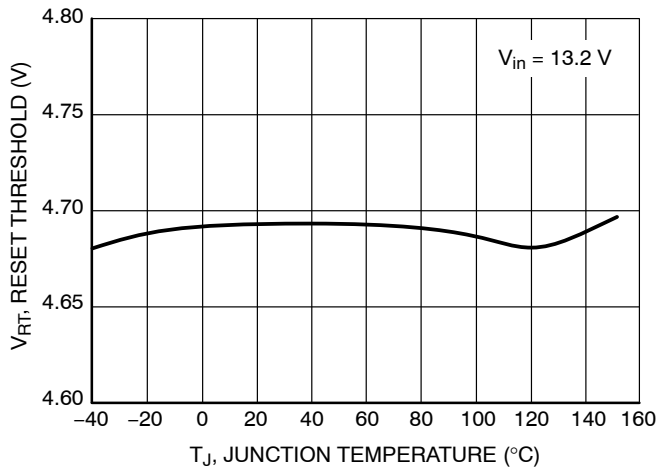

Figure 22. Reset Threshold vs Temperature

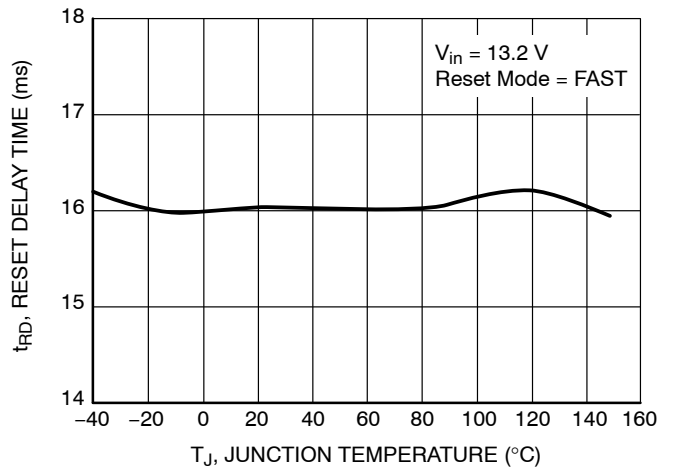

Figure 23. Reset Delay Time vs Temperature

TYPICAL CHARACTERISTICS

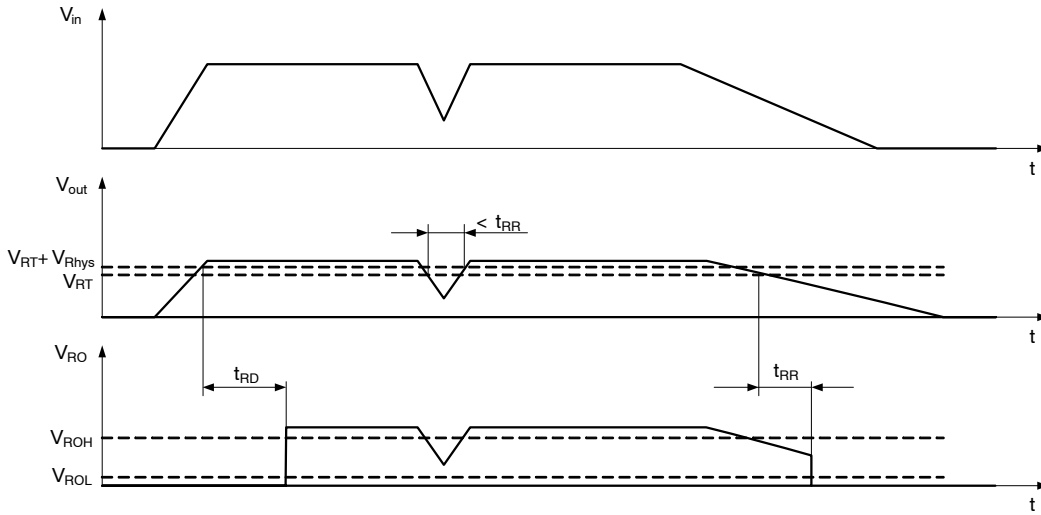
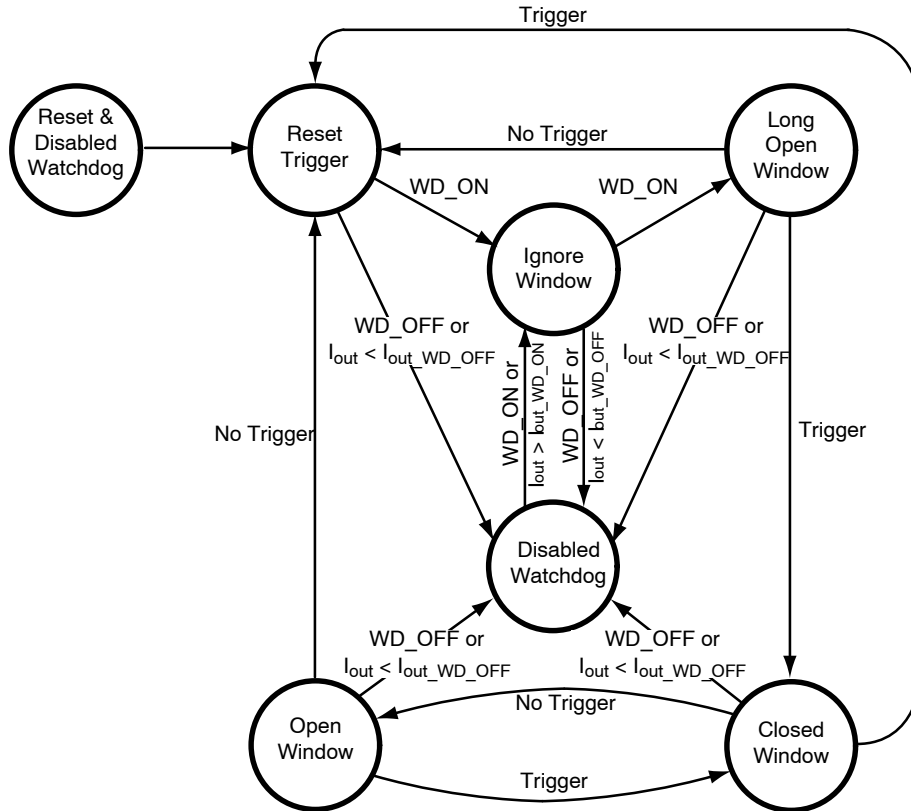

Figure 24. Reset Function and Timing Diagram



WM1	L	L	H	H
WM2	L	H	L	H
Window Watchdog Mode	FAST	SLOW	FAST	OFF
Reset Mode	FAST	SLOW	SLOW	SLOW

Figure 25. Window Watchdog State Diagram, Watchdog and Reset Modes

TYPICAL CHARACTERISTICS

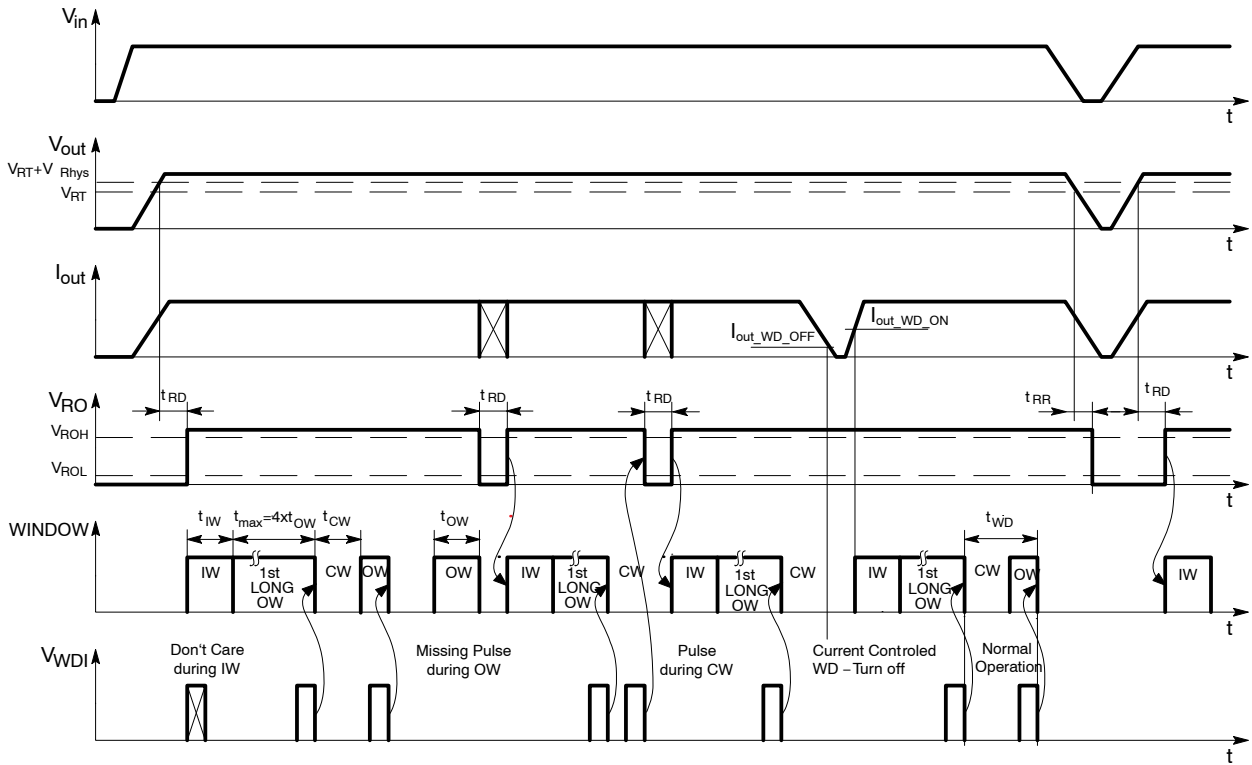

Figure 26. Window Watchdog Signal Diagram

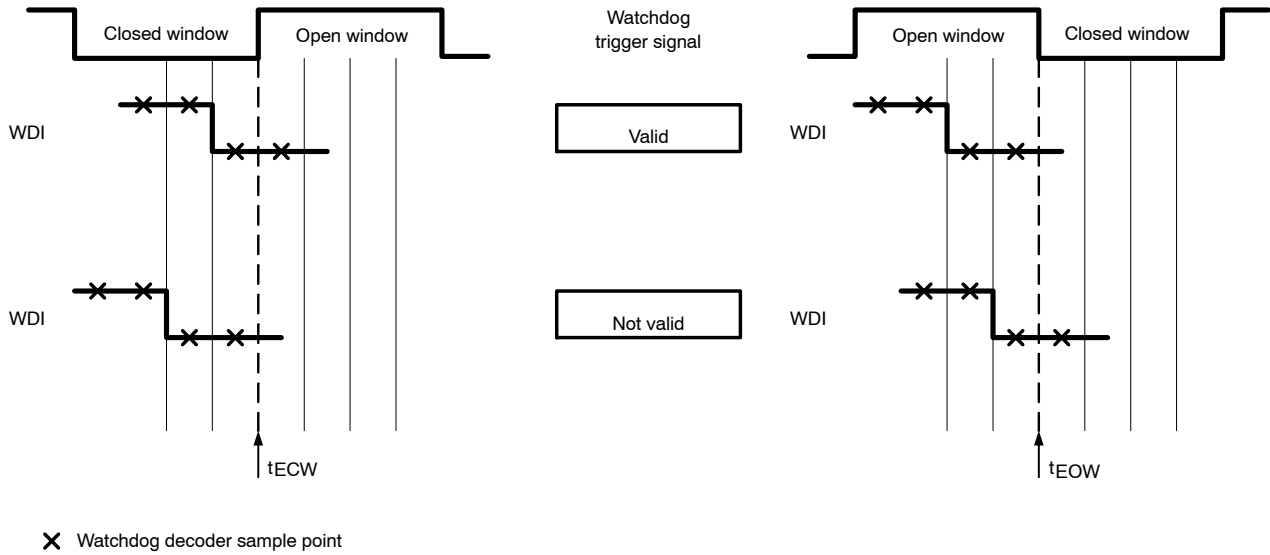

Figure 27. Valid WDI trigger signal

## DEFINITIONS

### General

All measurements are performed using short pulse low duty cycle techniques to maintain junction temperature as close as possible to ambient temperature.

### Output Voltage

The output voltage parameter is defined for specific temperature, input voltage and output current values or specified over Line, Load and Temperature ranges.

### Line Regulation

The change in output voltage for a change in input voltage measured for specific output current over operating ambient temperature range.

### Load Regulation

The change in output voltage for a change in output current measured for specific input voltage over operating ambient temperature range.

### Dropout Voltage

The input to output differential at which the regulator output no longer maintains regulation against further reductions in input voltage. It is measured when the output drops 100 mV below its nominal value. The junction temperature, load current, and minimum input supply requirements affect the dropout level.

### Quiescent Currents

Quiescent Current ( $I_q$ ) is the difference between the input current (measured through the LDO input pin) and the output current.

### Current Limit and Short Circuit Current Limit

Current Limit is value of output current by which output voltage drops below 96% of its nominal value. Short Circuit Current Limit is output current value measured with output of the regulator shorted to ground.

### PSRR

Power Supply Rejection Ratio is defined as ratio of output voltage and input voltage ripple. It is measured in decibels (dB).

### Line Transient Response

Typical output voltage overshoot and undershoot response when the input voltage is excited with a given slope.

### Load Transient Response

Typical output voltage overshoot and undershoot response when the output current is excited with a given slope between low-load and high-load conditions.

### Thermal Protection

Internal thermal shutdown circuitry is provided to protect the integrated circuit in the event that the maximum junction temperature is exceeded. When activated at typically 175°C, the regulator turns off. This feature is provided to prevent failures from accidental overheating.

### Maximum Package Power Dissipation

The power dissipation level is maximum allowed power dissipation for particular package or power dissipation at which the junction temperature reaches its maximum operating value, whichever is lower.

## APPLICATIONS INFORMATION

The NCV8768 regulator is self-protected with internal thermal shutdown and internal current limit. Typical characteristics are shown in Figures 4 to 27.

### Input Decoupling ( $C_{in}$ )

A ceramic or tantalum 0.1  $\mu$ F capacitor is recommended and should be connected close to the NCV8768 package. Higher capacitance and lower ESR will improve the overall line and load transient response.

If extremely fast input voltage transients are expected then appropriate input filter must be used in order to decrease rising and/or falling edges below 50 V/ $\mu$ s for proper operation. The filter can be composed of several capacitors in parallel.

### Output Decoupling ( $C_{out}$ )

The NCV8768 is a stable component and does not require a minimum Equivalent Series Resistance (ESR) for the output capacitor. Stability region of ESR versus Output Current is shown in Figure 13. The minimum output

decoupling value is 1.0  $\mu$ F and can be augmented to fulfill stringent load transient requirements. The regulator works with ceramic chip capacitors as well as tantalum devices. Larger values improve noise rejection and load regulation transient response.

### Enable Operation

The Enable pin will turn the regulator on or off. The threshold limits are covered in the electrical characteristics table in this data sheet.

### Reset Operation

A reset signal is provided on the Reset Output (RO) pin to provide feedback to the microprocessor of an out of regulation condition. The timing diagram of reset function is shown in Figure 24. This is in the form of a logic signal on RO. Output voltage conditions below the RESET threshold cause RO to go low. The RO integrity is maintained down to  $V_{OUT} = 1.0$  V. The Reset Output (RO) circuitry includes

a pull-up resistor (30 kΩ) internally connected to the output (V<sub>OUT</sub>). No external pull-up is necessary.

**Window Watchdog Operation**

The watchdog slow, fast or off state is set by pins WM1 and WM2 (see table in Figure 25). The timing values used in this description refer to typ. Values when WM1 and WM2 are connected to GND (fast watchdog and reset timing). The state diagram of the window watchdog (WWD) and the watchdog and reset mode selection table is shown in Figure 25. The WWD timing is shown in Figure 26. After power-on, the reset output signal at the RO pin (microprocessor reset) is kept LOW for the reset delay time t<sub>RD</sub> (16 ms). RO signal transition from LOW to HIGH triggers the ignore window (IW) with duration of t<sub>IW</sub> (32 ms). During this window the signal at the WDI pin is ignored. When IW ends a long open window with maximum duration of (128 ms, t<sub>max</sub> = 4xt<sub>OW</sub>) is started. When a valid trigger signal is detected during long open window, a closed window (CW) with duration of t<sub>CW</sub> (32 ms) is initialized immediately. WDI signal transition from HIGH to LOW is taken as a trigger. As valid trigger two HIGH samples followed by two LOW samples (with sampling time t<sub>sam</sub> = 0.5 ms) have to be present before end of the long window. Valid WDI trigger signal is shown in Figure 27. When CW ends a standard open window (OW) with maximum duration of t<sub>OW</sub> (32 ms) is initiated immediately. The OW ends immediately when valid trigger appears at WDI input. For normal operation the microprocessor timing of WDI pulses must be stable and correspond to t<sub>WD</sub>. A reset signal is generated (RO goes LOW) if there is no valid trigger (missing pulse at WDI pin) during OW or if a pre-trigger occurs during the CW (unexpected pulse at WDI pin).

**Thermal Considerations**

As power in the NCV8768 increases, it might become necessary to provide some thermal relief. The maximum power dissipation supported by the device is dependent upon board design and layout. Mounting pad configuration on the PCB, the board material, and the ambient temperature affect the rate of junction temperature rise for the part. When the NCV8768 has good thermal conductivity through the PCB, the junction temperature will be relatively low with high power applications. The maximum dissipation the NCV8768 can handle is given by:

$$P_{D(MAX)} = \frac{[T_{J(MAX)} - T_A]}{R_{\theta JA}} \quad (\text{eq. 1})$$

Since T<sub>J</sub> is not recommended to exceed 150°C, then the NCV8768 soldered on 645 mm<sup>2</sup>, 1 oz copper area, FR4 can dissipate up to 1.3 W when the ambient temperature (T<sub>A</sub>) is 25°C. See Figure 28 for R<sub>θJA</sub> versus PCB area. The power dissipated by the NCV8768 can be calculated from the following equations:

$$P_D = V_{in}(I_q@I_{out}) + I_{out}(V_{in} - V_{out}) \quad (\text{eq. 2})$$

or

$$V_{in(MAX)} = \frac{P_{D(MAX)} + (V_{out} \times I_{out})}{I_{out} + I_q} \quad (\text{eq. 3})$$

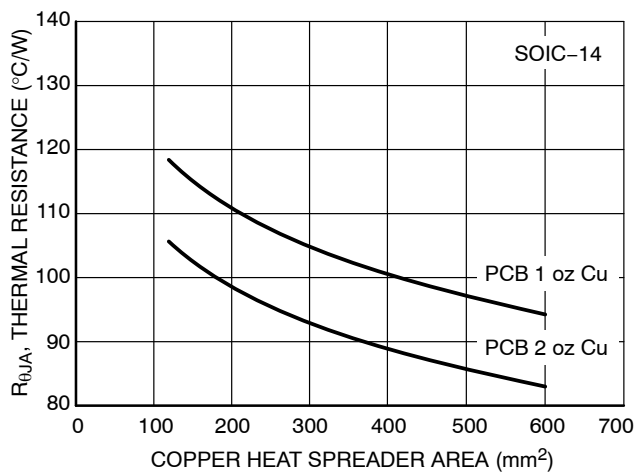

**Figure 28. Thermal Resistance vs PCB Copper Area**

**Hints**

V<sub>in</sub> and GND printed circuit board traces should be as wide as possible. When the impedance of these traces is high, there is a chance to pick up noise or cause the regulator to malfunction. Place external components, especially the output capacitor, as close as possible to the NCV8768, and make traces as short as possible.

# NCV8768

## ORDERING INFORMATION

Device	V <sub>out</sub>	t <sub>RD</sub> Fast/ Slow	IW/OW/CW Time Fast/ Slow	1 <sup>st</sup> LOW Time Fast/ Slow	V <sub>RT</sub>	Output Current WW ON/ OFF	Marking	Package	Shipping <sup>†</sup>
NCV8768ABD250R2G	5.0 V	16 / 32 ms	32 / 64 ms	128 / 256 ms	93%	Yes	V8768AB50G	SOIC-14 (Pb-Free)	2500 / Tape & Reel

†For information on tape and reel specifications, including part orientation and tape sizes, please refer to our Tape and Reel Packaging Specifications Brochure, BRD8011/D.

NOTE: Contact factory for other package, output voltage, timing and reset threshold options



# MECHANICAL CASE OUTLINE PACKAGE DIMENSIONS

ON Semiconductor®



SCALE 1:1

SOIC-14 NB  
CASE 751A-03  
ISSUE L

DATE 03 FEB 2016

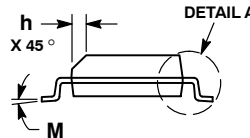

NOTES:

1. DIMENSIONING AND TOLERANCING PER ASME Y14.5M, 1994.
2. CONTROLLING DIMENSION: MILLIMETERS.
3. DIMENSION b DOES NOT INCLUDE DAMBAR PROTRUSION. ALLOWABLE PROTRUSION SHALL BE 0.13 TOTAL IN EXCESS OF AT MAXIMUM MATERIAL CONDITION.
4. DIMENSIONS D AND E DO NOT INCLUDE MOLD PROTRUSIONS.
5. MAXIMUM MOLD PROTRUSION 0.15 PER SIDE.

DIM	MILLIMETERS		INCHES	
	MIN	MAX	MIN	MAX
A	1.35	1.75	0.054	0.068
A1	0.10	0.25	0.004	0.010
A3	0.19	0.25	0.008	0.010
b	0.35	0.49	0.014	0.019
D	8.55	8.75	0.337	0.344
E	3.80	4.00	0.150	0.157
e	1.27 BSC		0.050 BSC	
H	5.80	6.20	0.228	0.244
h	0.25	0.50	0.010	0.019
L	0.40	1.25	0.016	0.049
M	0°	7°	0°	7°

SOLDERING FOOTPRINT\*

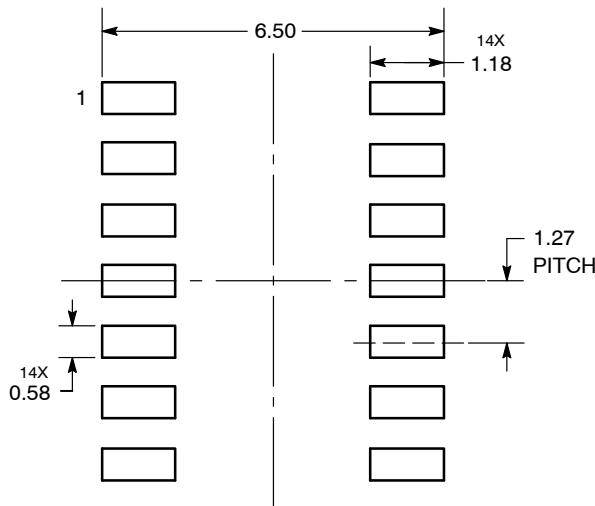

DIMENSIONS: MILLIMETERS

\*For additional information on our Pb-Free strategy and soldering details, please download the ON Semiconductor Soldering and Mounting Techniques Reference Manual, SOLDERRM/D.

GENERIC MARKING DIAGRAM\*

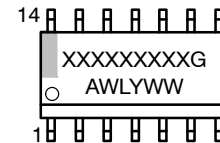

- XXXXXX = Specific Device Code
- A = Assembly Location
- WL = Wafer Lot
- Y = Year
- WW = Work Week
- G = Pb-Free Package

\*This information is generic. Please refer to device data sheet for actual part marking. Pb-Free indicator, "G" or microdot "▪", may or may not be present.

STYLES ON PAGE 2

DOCUMENT NUMBER:	98ASB42565B	Electronic versions are uncontrolled except when accessed directly from the Document Repository. Printed versions are uncontrolled except when stamped "CONTROLLED COPY" in red.
DESCRIPTION:	SOIC-14 NB	PAGE 1 OF 2

ON Semiconductor and ON are trademarks of Semiconductor Components Industries, LLC dba ON Semiconductor or its subsidiaries in the United States and/or other countries. ON Semiconductor reserves the right to make changes without further notice to any products herein. ON Semiconductor makes no warranty, representation or guarantee regarding the suitability of its products for any particular purpose, nor does ON Semiconductor assume any liability arising out of the application or use of any product or circuit, and specifically disclaims any and all liability, including without limitation special, consequential or incidental damages. ON Semiconductor does not convey any license under its patent rights nor the rights of others.

**SOIC-14**  
**CASE 751A-03**  
**ISSUE L**

DATE 03 FEB 2016

STYLE 1:  
 PIN 1. COMMON CATHODE  
 2. ANODE/CATHODE  
 3. ANODE/CATHODE  
 4. NO CONNECTION  
 5. ANODE/CATHODE  
 6. NO CONNECTION  
 7. ANODE/CATHODE  
 8. ANODE/CATHODE  
 9. ANODE/CATHODE  
 10. NO CONNECTION  
 11. ANODE/CATHODE  
 12. ANODE/CATHODE  
 13. NO CONNECTION  
 14. COMMON ANODE

STYLE 2:  
 CANCELLED

STYLE 3:  
 PIN 1. NO CONNECTION  
 2. ANODE  
 3. ANODE  
 4. NO CONNECTION  
 5. ANODE  
 6. NO CONNECTION  
 7. ANODE  
 8. ANODE  
 9. ANODE  
 10. NO CONNECTION  
 11. ANODE  
 12. ANODE  
 13. NO CONNECTION  
 14. COMMON CATHODE

STYLE 4:  
 PIN 1. NO CONNECTION  
 2. CATHODE  
 3. CATHODE  
 4. NO CONNECTION  
 5. CATHODE  
 6. NO CONNECTION  
 7. CATHODE  
 8. CATHODE  
 9. CATHODE  
 10. NO CONNECTION  
 11. CATHODE  
 12. CATHODE  
 13. NO CONNECTION  
 14. COMMON ANODE

STYLE 5:  
 PIN 1. COMMON CATHODE  
 2. ANODE/CATHODE  
 3. ANODE/CATHODE  
 4. ANODE/CATHODE  
 5. ANODE/CATHODE  
 6. NO CONNECTION  
 7. COMMON ANODE  
 8. COMMON CATHODE  
 9. ANODE/CATHODE  
 10. ANODE/CATHODE  
 11. ANODE/CATHODE  
 12. ANODE/CATHODE  
 13. NO CONNECTION  
 14. COMMON ANODE

STYLE 6:  
 PIN 1. CATHODE  
 2. CATHODE  
 3. CATHODE  
 4. CATHODE  
 5. CATHODE  
 6. CATHODE  
 7. CATHODE  
 8. ANODE  
 9. ANODE  
 10. ANODE  
 11. ANODE  
 12. ANODE  
 13. ANODE  
 14. ANODE

STYLE 7:  
 PIN 1. ANODE/CATHODE  
 2. COMMON ANODE  
 3. COMMON CATHODE  
 4. ANODE/CATHODE  
 5. ANODE/CATHODE  
 6. ANODE/CATHODE  
 7. ANODE/CATHODE  
 8. ANODE/CATHODE  
 9. ANODE/CATHODE  
 10. ANODE/CATHODE  
 11. COMMON CATHODE  
 12. COMMON ANODE  
 13. ANODE/CATHODE  
 14. ANODE/CATHODE

STYLE 8:  
 PIN 1. COMMON CATHODE  
 2. ANODE/CATHODE  
 3. ANODE/CATHODE  
 4. NO CONNECTION  
 5. ANODE/CATHODE  
 6. ANODE/CATHODE  
 7. COMMON ANODE  
 8. COMMON ANODE  
 9. ANODE/CATHODE  
 10. ANODE/CATHODE  
 11. NO CONNECTION  
 12. ANODE/CATHODE  
 13. ANODE/CATHODE  
 14. COMMON CATHODE

<b>DOCUMENT NUMBER:</b>	<b>98ASB42565B</b>	Electronic versions are uncontrolled except when accessed directly from the Document Repository. Printed versions are uncontrolled except when stamped "CONTROLLED COPY" in red.
<b>DESCRIPTION:</b>	<b>SOIC-14 NB</b>	<b>PAGE 2 OF 2</b>

ON Semiconductor and  are trademarks of Semiconductor Components Industries, LLC dba ON Semiconductor or its subsidiaries in the United States and/or other countries. ON Semiconductor reserves the right to make changes without further notice to any products herein. ON Semiconductor makes no warranty, representation or guarantee regarding the suitability of its products for any particular purpose, nor does ON Semiconductor assume any liability arising out of the application or use of any product or circuit, and specifically disclaims any and all liability, including without limitation special, consequential or incidental damages. ON Semiconductor does not convey any license under its patent rights nor the rights of others.

ON Semiconductor and  are trademarks of Semiconductor Components Industries, LLC dba ON Semiconductor or its subsidiaries in the United States and/or other countries. ON Semiconductor owns the rights to a number of patents, trademarks, copyrights, trade secrets, and other intellectual property. A listing of ON Semiconductor's product/patent coverage may be accessed at [www.onsemi.com/site/pdf/Patent-Marking.pdf](http://www.onsemi.com/site/pdf/Patent-Marking.pdf). ON Semiconductor reserves the right to make changes without further notice to any products herein. ON Semiconductor makes no warranty, representation or guarantee regarding the suitability of its products for any particular purpose, nor does ON Semiconductor assume any liability arising out of the application or use of any product or circuit, and specifically disclaims any and all liability, including without limitation special, consequential or incidental damages. Buyer is responsible for its products and applications using ON Semiconductor products, including compliance with all laws, regulations and safety requirements or standards, regardless of any support or applications information provided by ON Semiconductor. "Typical" parameters which may be provided in ON Semiconductor data sheets and/or specifications can and do vary in different applications and actual performance may vary over time. All operating parameters, including "Typicals" must be validated for each customer application by customer's technical experts. ON Semiconductor does not convey any license under its patent rights nor the rights of others. ON Semiconductor products are not designed, intended, or authorized for use as a critical component in life support systems or any FDA Class 3 medical devices or medical devices with a same or similar classification in a foreign jurisdiction or any devices intended for implantation in the human body. Should Buyer purchase or use ON Semiconductor products for any such unintended or unauthorized application, Buyer shall indemnify and hold ON Semiconductor and its officers, employees, subsidiaries, affiliates, and distributors harmless against all claims, costs, damages, and expenses, and reasonable attorney fees arising out of, directly or indirectly, any claim of personal injury or death associated with such unintended or unauthorized use, even if such claim alleges that ON Semiconductor was negligent regarding the design or manufacture of the part. ON Semiconductor is an Equal Opportunity/Affirmative Action Employer. This literature is subject to all applicable copyright laws and is not for resale in any manner.

## PUBLICATION ORDERING INFORMATION

### LITERATURE FULFILLMENT:

Email Requests to: [orderlit@onsemi.com](mailto:orderlit@onsemi.com)

ON Semiconductor Website: [www.onsemi.com](http://www.onsemi.com)

### TECHNICAL SUPPORT

North American Technical Support:  
Voice Mail: 1 800-282-9855 Toll Free USA/Canada  
Phone: 011 421 33 790 2910

### Europe, Middle East and Africa Technical Support:

Phone: 00421 33 790 2910

For additional information, please contact your local Sales Representative