



# PJW5N10A

## 100V N-Channel Enhancement Mode MOSFET

**Voltage**

**100 V**

**Current**

**5 A**

### Features

- $R_{DS(ON)}$ ,  $V_{GS}@10V$ ,  $I_D@4A < 115m\Omega$
- $R_{DS(ON)}$ ,  $V_{GS}@4.5V$ ,  $I_D@2A < 120m\Omega$
- Advanced Trench Process Technology
- High density cell design for ultra low on-resistance
- Lead free in compliance with EU RoHS 2.0
- Green molding compound as per IEC 61249 standard

### Mechanical Data

- Case : SOT-223 Package
- Terminals : Solderable per MIL-STD-750, Method 2026
- Approx. Weight : 0.043 ounces, 0.123 grams

SOT-223

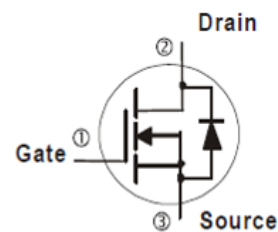
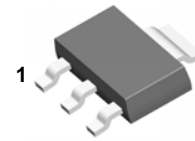

### Maximum Ratings and Thermal Characteristics ( $T_A=25^\circ\text{C}$ unless otherwise noted)

PARAMETER		SYMBOL	LIMIT	UNITS
Drain-Source Voltage		$V_{DS}$	100	V
Gate-Source Voltage		$V_{GS}$	$\pm 20$	
Continuous Drain Current	$T_C=25^\circ\text{C}$	$I_D$	5	A
	$T_C=100^\circ\text{C}$		3.1	
Pulsed Drain Current (Note 1)	$T_C=25^\circ\text{C}$	$I_{DM}$	16	
Power Dissipation	$T_C=25^\circ\text{C}$	$P_D$	5.2	W
	$T_C=100^\circ\text{C}$		2.1	
Continuous Drain Current (Note 4)	$T_A=25^\circ\text{C}$	$I_D$	3.5	A
	$T_A=70^\circ\text{C}$		2.8	
Power Dissipation	$T_A=25^\circ\text{C}$	$P_D$	3.1	W
	$T_A=70^\circ\text{C}$		2	
Operating Junction and Storage Temperature Range		$T_J, T_{STG}$	-55~150	$^\circ\text{C}$
Typical Thermal Resistance (Note 4,5)	Junction to Case	$R_{\theta JC}$	24	$^\circ\text{C/W}$
	Junction to Ambient	$R_{\theta JA}$	69.4	

- Limited only By Maximum Junction Temperature



# PJW5N10A

## Electrical Characteristics ( $T_A=25^\circ\text{C}$ unless otherwise noted)

PARAMETER	SYMBOL	TEST CONDITION	MIN.	TYP.	MAX.	UNITS
<b>Static</b>						
Drain-Source Breakdown Voltage	$BV_{DSS}$	$V_{GS}=0V, I_D=250\mu A$	100	-	-	V
Gate Threshold Voltage	$V_{GS(th)}$	$V_{DS}=V_{GS}, I_D=250\mu A$	1	1.76	2.5	
Drain-Source On-State Resistance	$R_{DS(on)}$	$V_{GS}=10V, I_D=4A$	-	92	115	m $\Omega$
		$V_{GS}=4.5V, I_D=2A$	-	95	120	
Zero Gate Voltage Drain Current	$I_{DSS}$	$V_{DS}=100V, V_{GS}=0V$	-	-	1	$\mu A$
Gate-Source Leakage Current	$I_{GSS}$	$V_{GS}=\pm 20V, V_{DS}=0V$	-	-	$\pm 100$	nA
<b>Dynamic</b> (Note 6)						
Total Gate Charge	$Q_g$	$V_{DS}=50V, I_D=2A,$ $V_{GS}=10V$ (Note 1,2)	-	20	-	nC
Gate-Source Charge	$Q_{gs}$		-	3.2	-	
Gate-Drain Charge	$Q_{gd}$		-	3.6	-	
Input Capacitance	$C_{iss}$	$V_{DS}=25V, V_{GS}=0V,$ $f=1\text{MHz}$	-	1413	-	pF
Output Capacitance	$C_{oss}$		-	60	-	
Reverse Transfer Capacitance	$C_{rss}$		-	34	-	
Turn-On Delay Time	$t_{d(on)}$	$V_{DD}=50V, I_D=1A,$ $V_{GS}=10V,$ $R_G=3.3\Omega$ (Note 1,2)	-	18	-	ns
Turn-On Rise Time	$t_r$		-	4.3	-	
Turn-Off Delay Time	$t_{d(off)}$		-	41	-	
Turn-Off Fall Time	$t_f$		-	4.2	-	
<b>Drain-Source Diode</b>						
Maximum Continuous Drain-Source Diode Forward Current	$I_S$	---	-	-	5	A
Diode Forward Voltage	$V_{SD}$	$I_S=1A, V_{GS}=0V$	-	0.73	1	V

**NOTES :**

1. Pulse width  $\leq 300\mu s$ , Duty cycle  $\leq 2\%$ .
2. Essentially independent of operating temperature typical characteristics.
3. Repetitive rating, pulse width limited by junction temperature  $T_{J(MAX)}=150^\circ\text{C}$ . Ratings are based on low frequency and duty cycles to keep initial  $T_J=25^\circ\text{C}$ .
4. The maximum current rating is package limited.
5.  $R_{\theta JA}$  is the sum of the junction-to-case and case-to-ambient thermal resistance where the case thermal reference is defined as the solder mounting surface of the drain pins. Mounted on a 1 inch<sup>2</sup> with 2oz.square pad of copper.
6. Guaranteed by design, not subject to production testing.



# PJW5N10A

## TYPICAL CHARACTERISTIC CURVES

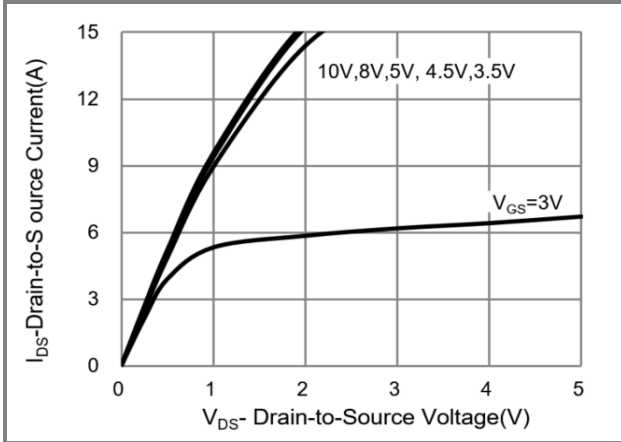

Fig.1 Output Characteristics

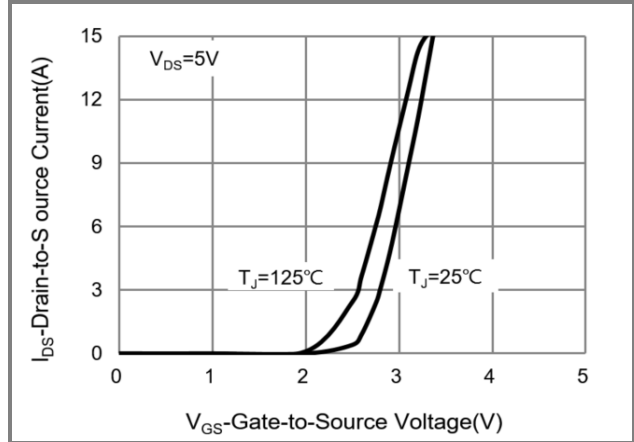

Fig.2 Transfer Characteristics

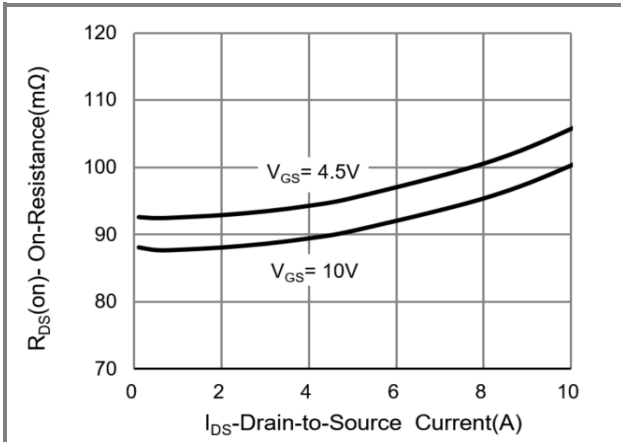

Fig.3 On-Resistance vs. Drain Current

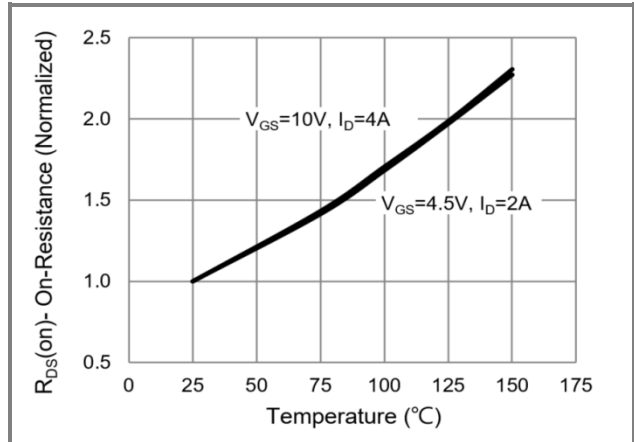

Fig.4 On-Resistance vs. Junction temperature

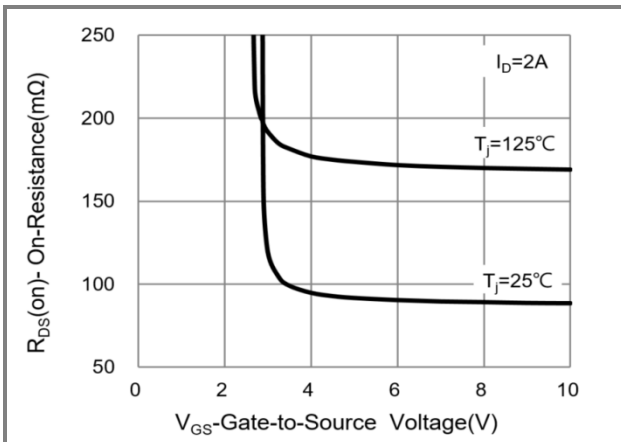

Fig.5 On-Resistance Variation with  $V_{GS}$

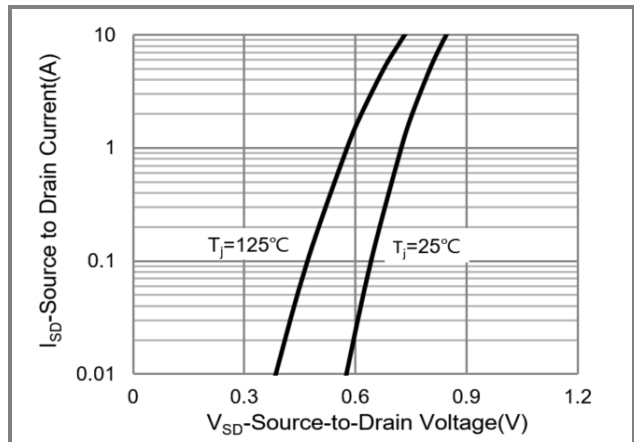

Fig.6 Source-Drain Diode Forward Voltage



# PJW5N10A

## TYPICAL CHARACTERISTIC CURVES

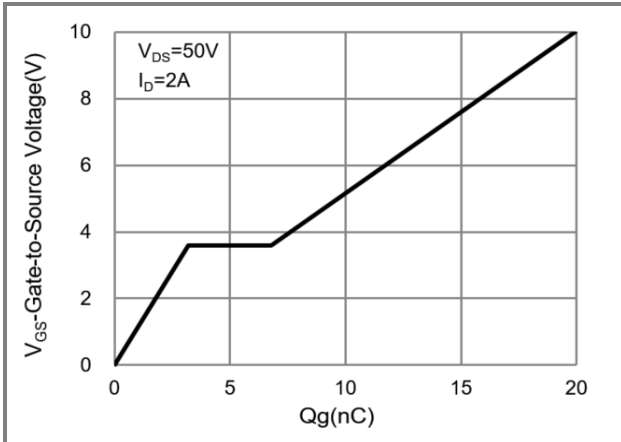

Fig.7 Gate-Charge Characteristics

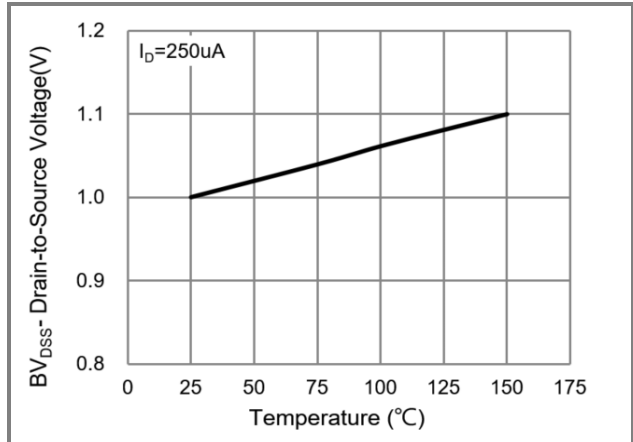

Fig.8 Breakdown Voltage Variation vs. Temperature

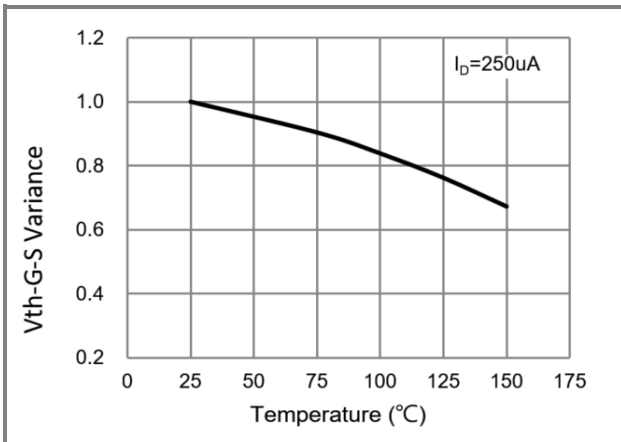

Fig.9 Threshold Voltage Variation with Temperature

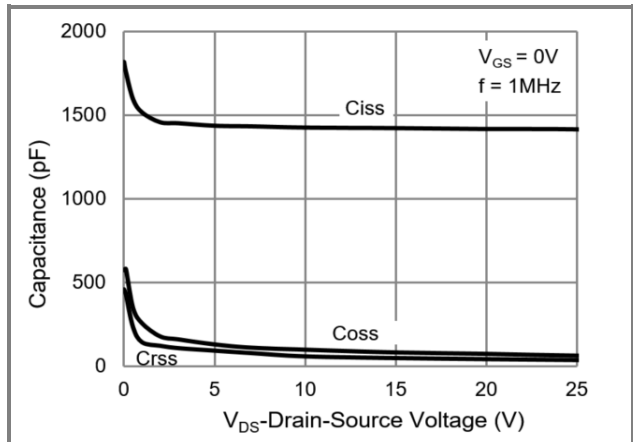

Fig.10 Capacitance vs. Drain-Source Voltage

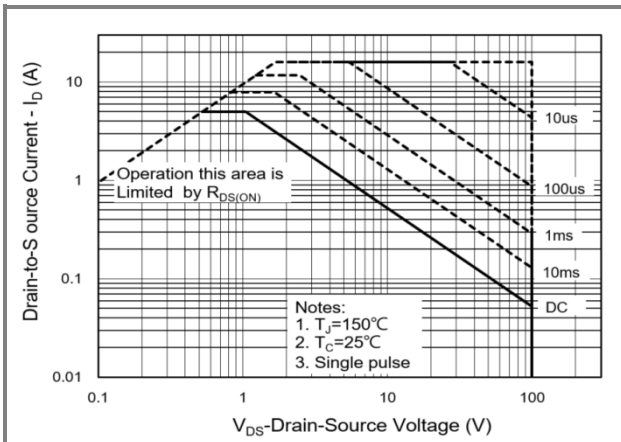

Fig.11 Maximum Safe Operating Area

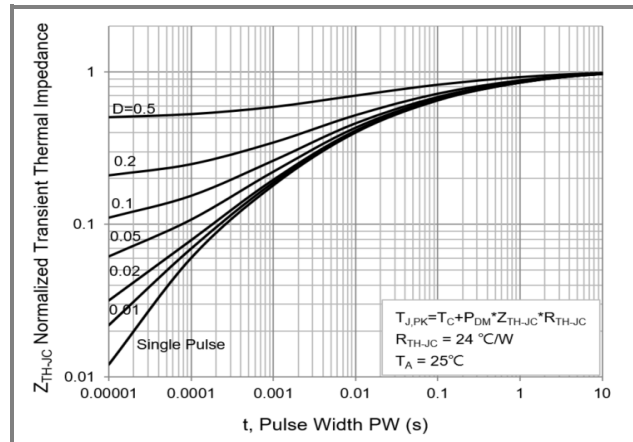
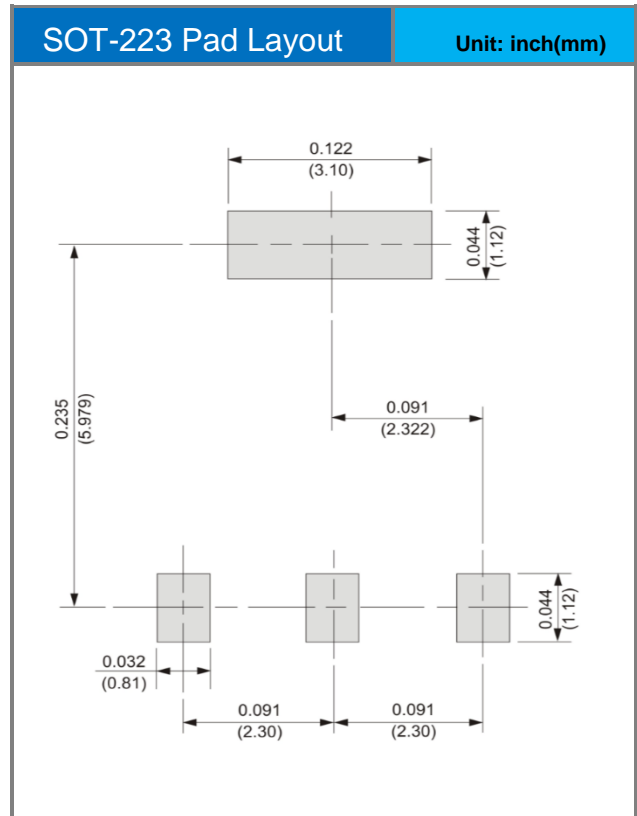
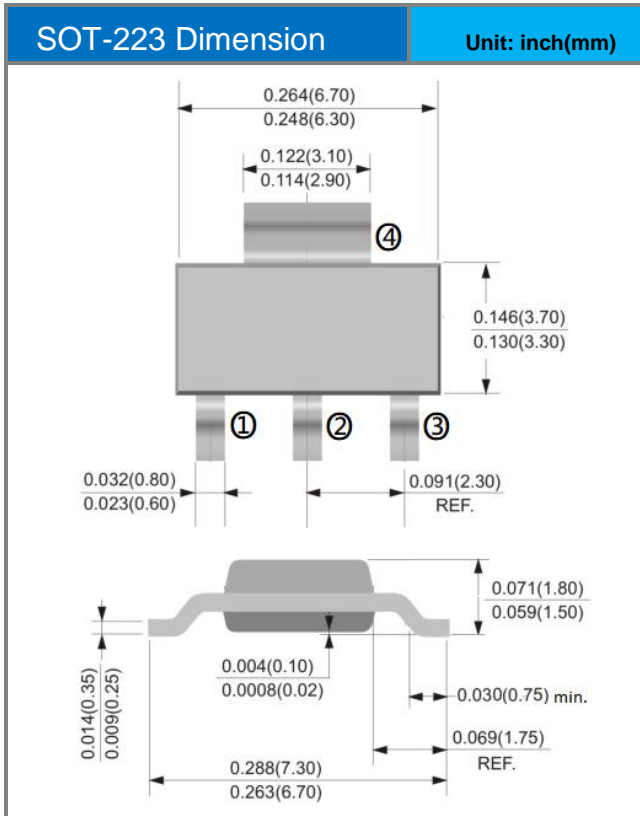

Fig.12 Normalized Transient Thermal Impedance



# PJW5N10A

## Packaging Information & Mounting Pad Layout





# PJW5N10A

## Part No Packing Code Version

Part No Packing Code	Package Type	Packing Type	Marking	Version
PJW5N10A_R2_00001	SOT-223	2,500pcs / 13" reel	W5N10A	Halogen free



## PJW5N10A

### Disclaimer

- Reproducing and modifying information of the document is prohibited without permission from Panjit International Inc..
- Panjit International Inc. reserves the rights to make changes of the content herein the document anytime without notification. Please refer to our website for the latest document.
- Panjit International Inc. disclaims any and all liability arising out of the application or use of any product including damages incidentally and consequentially occurred.
- Panjit International Inc. does not assume any and all implied warranties, including warranties of fitness for particular purpose, non-infringement and merchantability.
- Applications shown on the herein document are examples of standard use and operation. Customers are responsible in comprehending the suitable use in particular applications. Panjit International Inc. makes no representation or warranty that such applications will be suitable for the specified use without further testing or modification.
- The products shown herein are not designed and authorized for equipments requiring high level of reliability or relating to human life and for any applications concerning life-saving or life-sustaining, such as medical instruments, transportation equipment, aerospace machinery et cetera. Customers using or selling these products for use in such applications do so at their own risk and agree to fully indemnify Panjit International Inc. for any damages resulting from such improper use or sale.
- Since Panjit uses lot number as the tracking base, please provide the lot number for tracking when complaining.