



Isolator

SMD

CU4S0506 Series

5x5mm*

* Dimensions Code JIS

Isolator

SMD

Overview of CU4S0506 Series

PART NUMBER CONSTRUCTION

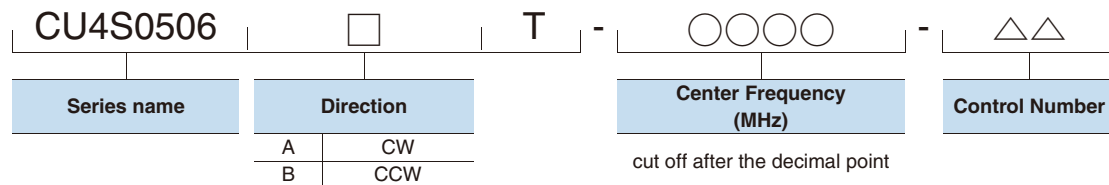

DIRECTION OF CIRCULATION

ClockWise(CW): A

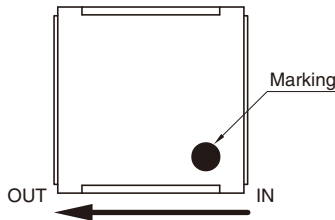

CounterClockWise(CCW): B

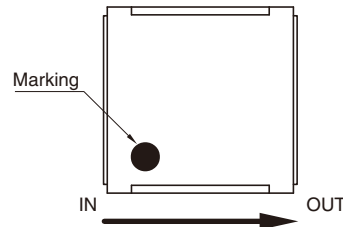

TEMPERATURE RANGE

Operating temperature (°C)	Storage temperature (°C)
-35 to +85	-40 to +85

○ RoHS Directive Compliant Product: See the following for more details related to RoHS Directive compliant products. <http://product.tdk.com/en/environment/rohs/>

- All specifications are subject to change without notice.
- Before using these products, be sure to request the delivery specifications.

CU4S0506 Series (Under 1GHz)

SHAPES AND DIMENSIONS

[Top view]

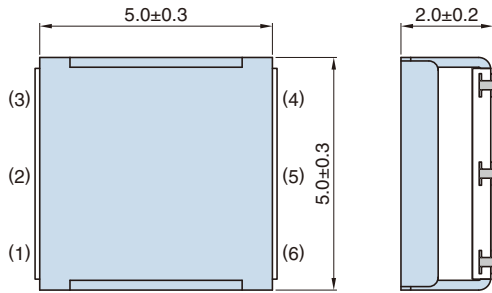

■ Terminal (Au plating)
 ■ Metal parts other than a terminal. (GND electric potential)

Tolerance unless otherwise specified: ± 0.2
 Coplanarity : 0.1max.

[Bottom view]

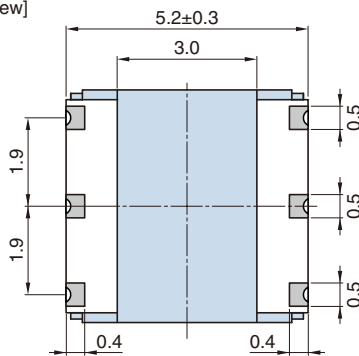

Terminal functions

1	OUT	IN
2	GROUND	GROUND
3	GROUND	GROUND
4	GROUND	GROUND
5	GROUND	GROUND
6	IN	OUT
Rotation	Clockwise	Counter Clockwise

Dimensions in mm

[Marking]

ClockWise(CW): A

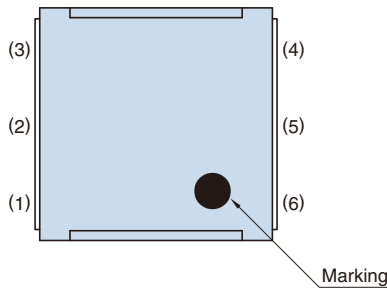

CounterClockWise(CCW): B

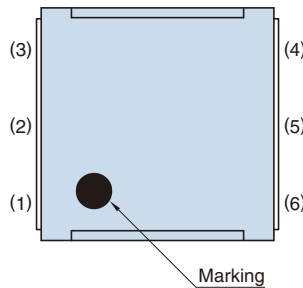

RECOMMENDED LAND PATTERN

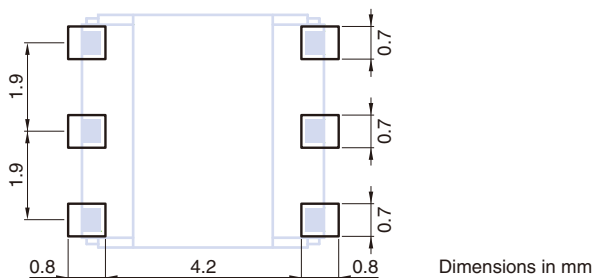

Dimensions in mm

RECOMMENDED PC BOARD PATTERN

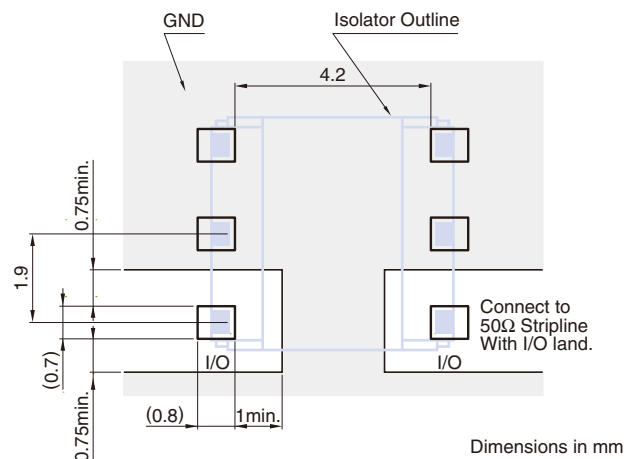

Dimensions in mm

- All specifications are subject to change without notice.
- Before using these products, be sure to request the delivery specifications.

CU4S0506 Series (Under 1GHz)

ELECTRICAL CHARACTERISTICS

Frequency range (MHz)	Center frequency (MHz)	Isolation (dB) min.	Insertion loss (dB) max.	V.S.W.R. Zo=50Ω max.	Handling power (W) max.	Reflection power (W) ^{*4} max.	Part Number	
							ClockWise	CounterClockWise
699 to 716	707.5	13	0.90	1.6	5	2	CU4S0506AT-707-00	CU4S0506BT-707-00
704 to 716	710	14	0.90	1.6	5	2	CU4S0506AT-710-00	CU4S0506BT-710-00
716 to 728	722	14	0.90	1.6	5	2	CU4S0506AT-722-00	CU4S0506BT-722-00
703 to 748	725.5	10	1.20	1.8	5	2	CU4S0506AT-725-00	CU4S0506BT-725-00
718 to 748	733	12	0.90	1.7	5	2	CU4S0506AT-733-00	CU4S0506BT-733-00
729 to 746	737.5	13	0.80	1.6	5	2	CU4S0506AT-737-00	CU4S0506BT-737-00
734 to 746	740	14	0.80	1.5	5	2	CU4S0506AT-740-00	CU4S0506BT-740-00
746 to 756	751	15	0.80	1.5	5	2	CU4S0506AT-751-00	CU4S0506BT-751-00
758 to 768	763	15	0.80	1.5	5	2	CU4S0506AT-763-00	CU4S0506BT-763-00
758 to 803	780.5	10	1.20	1.8	5	2	CU4S0506AT-780-00	CU4S0506BT-780-00
777 to 787	782	15	0.80	1.5	5	2	CU4S0506AT-782-00	CU4S0506BT-782-00
773 to 803	788	12	0.90	1.7	5	2	CU4S0506AT-788-00	CU4S0506BT-788-00
788 to 798	793	15	0.80	1.5	5	2	CU4S0506AT-793-00	CU4S0506BT-793-00
791 to 821	806	12	0.85	1.7	5	2	CU4S0506AT-806-00	CU4S0506BT-806-00
807 to 824	815.5	14	0.75	1.6	5	2	CU4S0506AT-815-00	CU4S0506BT-815-00
815 to 830	822.5	14	0.75	1.6	5	2	CU4S0506AT-822-00	CU4S0506BT-822-00
815 to 845	830	13	0.80	1.6	5	2	CU4S0506AT-830-00	CU4S0506BT-830-00
814 to 849	831.5	12	0.90	1.7	5	2	CU4S0506AT-831-00	CU4S0506BT-831-00
824 to 849	836.5	13	0.80	1.6	5	2	CU4S0506AT-836-00	CU4S0506BT-836-00
830 to 845	837.5	14	0.75	1.6	5	2	CU4S0506AT-837-00	CU4S0506BT-837-00
832 to 862	847	13	0.80	1.6	5	2	CU4S0506AT-847-00	CU4S0506BT-847-00
852 to 869	860.5	14	0.75	1.6	5	2	CU4S0506AT-860-00	CU4S0506BT-860-00
860 to 875	867.5	14	0.75	1.6	5	2	CU4S0506AT-867-00	CU4S0506BT-867-00
860 to 890	875	13	0.75	1.6	5	2	CU4S0506AT-875-00	CU4S0506BT-875-00
859 to 894	876.5	12	0.85	1.7	5	2	CU4S0506AT-876-00	CU4S0506BT-876-00
869 to 894	881.5	13	0.75	1.6	5	2	CU4S0506AT-881-00	CU4S0506BT-881-00
875 to 890	882.5	14	0.75	1.6	5	2	CU4S0506AT-882-00	CU4S0506BT-882-00
880 to 915	897.5	12	0.85	1.7	5	2	CU4S0506AT-897-00	CU4S0506BT-897-00
900 to 915	907.5	14	0.70	1.5	5	2	CU4S0506AT-907-00	CU4S0506BT-907-00
925 to 960	942.5	12	0.80	1.7	5	2	CU4S0506AT-942-00	CU4S0506BT-942-00
945 to 960	952.5	14	0.70	1.5	5	2	CU4S0506AT-952-00	CU4S0506BT-952-00

Characteristic Impedance (Ω) : 50(Nominal)

*4 To be kept below +85deg.C at the bottom surface

- All specifications are subject to change without notice.
- Before using these products, be sure to request the delivery specifications.

CU4S0506 Series (Over 1GHz)

SHAPES AND DIMENSIONS

[Top view]

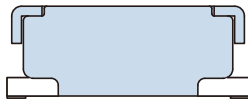
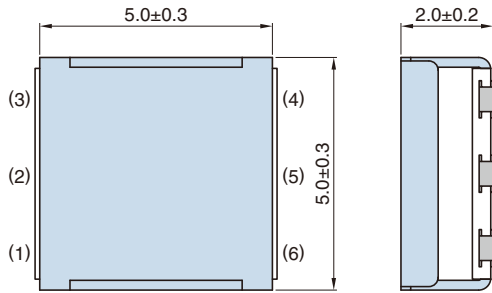

■ Terminal (Au plating)
 ■ Metal parts other than a terminal. (GND electric potential)

Tolerance unless otherwise specified: ± 0.2
 Coplanarity : 0.1max.

[Bottom view]

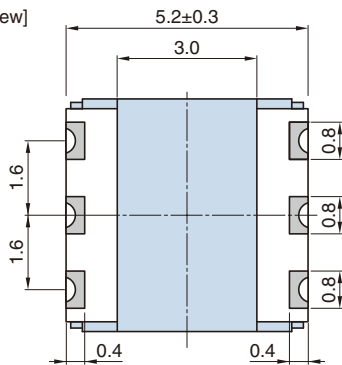

Terminal functions

1	OUT	IN
2	GROUND	GROUND
3	GROUND	GROUND
4	GROUND	GROUND
5	GROUND	GROUND
6	IN	OUT
Rotation	Clockwise	Counter Clockwise

Dimensions in mm

[Marking]

ClockWise(CW): A

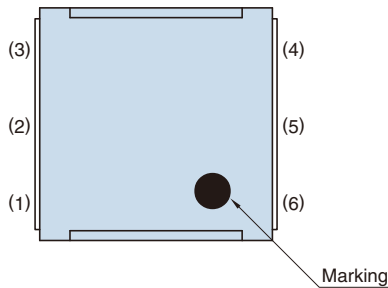

CounterClockWise(CCW): B

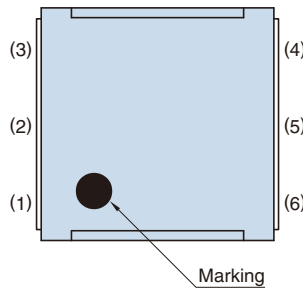

RECOMMENDED LAND PATTERN

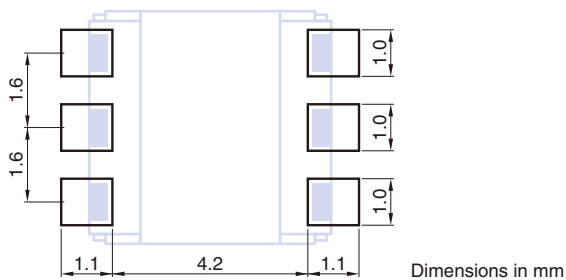

Dimensions in mm

RECOMMENDED PC BOARD PATTERN

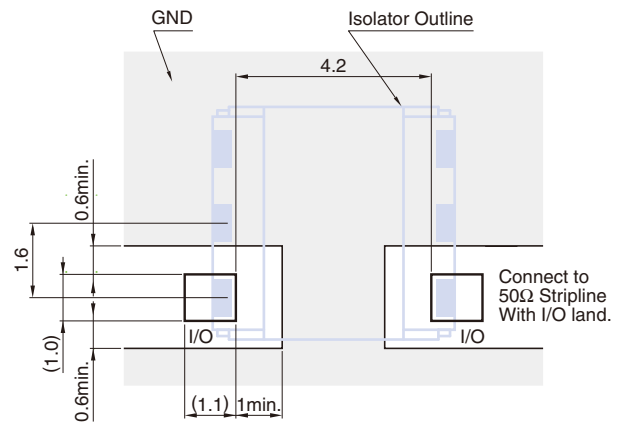

Dimensions in mm

- All specifications are subject to change without notice.
- Before using these products, be sure to request the delivery specifications.

CU4S0506 Series (Over 1GHz)

ELECTRICAL CHARACTERISTICS

Frequency range (MHz)	Center frequency (MHz)	Isolation (dB) min.	Insertion loss (dB) max.	V.S.W.R. Zo=50Ω max.	Handling power (W) max.	Reflection power (W) ^{*4} max.	Part Number	
							ClockWise	CounterClockWise
1427.9 to 1462.9	1445.4	15	0.60	1.5	5	2	CU4S0506AT-1445-00	CU4S0506BT-1445-00
1475.9 to 1510.9	1493.4	15	0.60	1.5	5	2	CU4S0506AT-1493-00	CU4S0506BT-1493-00
1525 to 1559	1542	15	0.60	1.5	5	2	CU4S0506AT-1542-00	CU4S0506BT-1542-00
1626.5 to 1660.5	1643.5	15	0.60	1.5	5	2	CU4S0506AT-1643-00	CU4S0506BT-1643-00
1710 to 1785	1747.5	13	0.80	1.6	5	2	CU4S0506AT-1747-00	CU4S0506BT-1747-00
1749.9 to 1784.9	1767.4	15	0.60	1.5	5	2	CU4S0506AT-1767-00	CU4S0506BT-1767-00
1805 to 1880	1842.5	14	0.70	1.5	5	2	CU4S0506AT-1842-00	CU4S0506BT-1842-00
1844.9 to 1879.9	1862.4	15	0.60	1.5	5	2	CU4S0506AT-1862-00	CU4S0506BT-1862-00
1850 to 1910	1880	15	0.60	1.5	5	2	CU4S0506AT-1880-00	CU4S0506BT-1880-00
1850 to 1915	1882.5	14	0.70	1.5	5	2	CU4S0506AT-1882-00	CU4S0506BT-1882-00
1880 to 1920	1900	15	0.60	1.5	5	2	CU4S0506AT-1900-00	CU4S0506BT-1900-00
1920 to 1980	1950	15	0.60	1.5	5	2	CU4S0506AT-1950-00	CU4S0506BT-1950-00
1930 to 1990	1960	15	0.60	1.5	5	2	CU4S0506AT-1960-00	CU4S0506BT-1960-00
1930 to 1995	1962.5	15	0.60	1.5	5	2	CU4S0506AT-1962-00	CU4S0506BT-1962-00
2010 to 2025	2017.5	15	0.60	1.5	5	2	CU4S0506AT-2017-00	CU4S0506BT-2017-00
2110 to 2170	2140	15	0.60	1.5	5	2	CU4S0506AT-2140-00	CU4S0506BT-2140-00
2305 to 2315	2310	15	0.60	1.5	5	2	CU4S0506AT-2310-00	CU4S0506BT-2310-00
2300 to 2400	2350	14	0.70	1.5	5	2	CU4S0506AT-2350-00	CU4S0506BT-2350-00
2350 to 2360	2355	15	0.60	1.5	5	2	CU4S0506AT-2355-00	CU4S0506BT-2355-00
2500 to 2570	2535	15	0.60	1.6	5	2	CU4S0506AT-2535-00	CU4S0506BT-2535-00
2496 to 2690	2593	12	0.80	1.7	5	2	CU4S0506AT-2593-00	CU4S0506BT-2593-00
2570 to 2620	2595	15	0.60	1.5	5	2	CU4S0506AT-2595-00	CU4S0506BT-2595-00
2620 to 2690	2655	15	0.60	1.6	5	2	CU4S0506AT-2655-00	CU4S0506BT-2655-00
3400 to 3600	3500	10	1.00	1.8	5	1	CU4S0506AT-3500-00	CU4S0506BT-3500-00
3480 to 3600	3540	10	1.00	1.8	5	1	CU4S0506AT-3540-00	CU4S0506BT-3540-00

Characteristic Impedance (Ω) : 50(Nominal)

*4 To be kept below +85deg.C at the bottom surface

- All specifications are subject to change without notice.
- Before using these products, be sure to request the delivery specifications.

CU4S0506 Series

PACKAGING STYLE

REEL DIMENSIONS

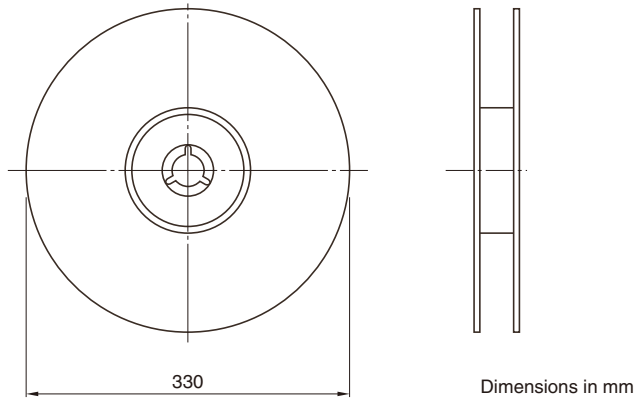

TAPE DIMENSIONS

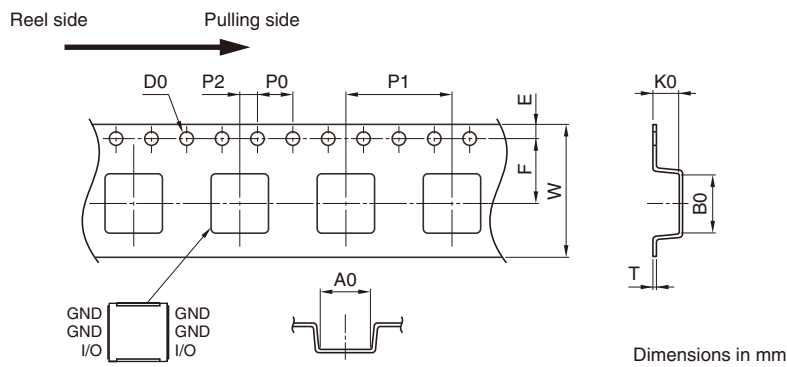

A0	B0	D0	E	F	P0	P1	P2	W	K0	T
5.6±0.1	5.6±0.1	1.5+0.1/-0	1.75±0.1	7.5±0.1	4.0±0.1	12.0±0.1	2.0±0.1	16.0+0.3/-0.1	2.6±0.1	0.3±0.05

PACKAGE QUANTITY

Standard package quantity (pieces/reel)
1000

- All specifications are subject to change without notice.
- Before using these products, be sure to request the delivery specifications.

CU4S0506 Series

RECOMMENDED REFLOW PROFILE

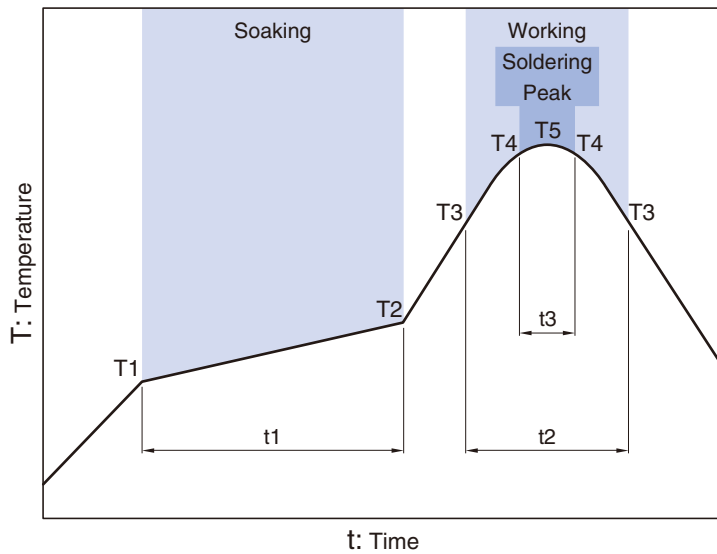

Soaking			Working		Soldering Peak		
Temp.	T2	Time	Temp.	Time	Temp.	Time	Temp.
T1	T2	t1	T3	t2	T4	t3	T5
150°C	180°C	60 to 120s	230°C	30 to 60s	250°C	within 10s	260°C max.

- All specifications are subject to change without notice.
- Before using these products, be sure to request the delivery specifications.

REMINDERS FOR USING THESE PRODUCTS

Before using these products, be sure to request the delivery specifications.

SAFETY REMINDERS

Please pay sufficient attention to the warnings for safe designing when using these products.

REMINDERS

Please do not bring the magnet close to the product (Recommending is separating to 50cm or more). An electric characteristic might be deteriorated.

The magnetic field of 5mT or more must not go into the product when you make the magnet approach.

Moreover, please do not touch a soft magnetic material such as iron (Recommending is separating to 10mm or more). An electric characteristic might be deteriorated. An electric characteristic changes when bringing it close within 10mm(reversible change).

There is a leakage of some magnetism (0.3T or less) from the product.

The products listed on this catalog are intended for use in general electronic equipment (AV equipment, telecommunications equipment, home appliances, amusement equipment, computer equipment, personal equipment, office equipment, measurement equipment, industrial robots) under a normal operation and use condition.

The products are not designed or warranted to meet the requirements of the applications listed below, whose performance and/or quality require a more stringent level of safety or reliability, or whose failure, malfunction or trouble could cause serious damage to society, person or property.

Please understand that we are not responsible for any damage or liability caused by use of the products in any of the applications below or for any other use exceeding the range or conditions set forth in this catalog.

- | | |
|---|--|
| (1) Aerospace/Aviation equipment | (8) Public information-processing equipment |
| (2) Transportation equipment (cars, electric trains, ships, etc.) | (9) Military equipment |
| (3) Medical equipment | (10) Electric heating apparatus, burning equipment |
| (4) Power-generation control equipment | (11) Disaster prevention/crime prevention equipment |
| (5) Atomic energy-related equipment | (12) Safety equipment |
| (6) Seabed equipment | (13) Other applications that are not considered general-purpose applications |
| (7) Transportation control equipment | |

When using this product in general-purpose applications, you are kindly requested to take into consideration securing protection circuit/equipment or providing backup circuits, etc., to ensure higher safety.