







Twin pushbutton, 22 mm, round, plastic, green: I, red: O, pushbuttons, flat

product brand name	SIRIUS ACT
product designation	Twin pushbuttons
design of the product	Actuating/signaling element
product type designation	3SU1
product line	Plastic, black, 22 mm
Enclosure	
number of command points	1
Actuator	
design of the actuating element	Flat buttons
principle of operation of the actuating element	momentary contact type
product extension optional	
• light source	No
• contact module	Yes
color of the actuating element	green / red
material of the actuating element	plastic
shape of the actuating element	oval
marking of the actuating element	"I","O"
Front ring	
product component front ring	Yes
design of the front ring	Standard
material of the front ring	plastic
color of the front ring	black
General technical data	
protection class IP	IP66, IP67, IP69(IP69K)
degree of protection NEMA rating	1, 2, 3, 3R, 4, 4X, 12, 13
shock resistance	
• acc. to IEC 60068-2-27	Sinusoidal half-wave 50g / 11 ms
• for railway applications acc. to DIN EN 61373	Category 1, Class B
vibration resistance	
• acc. to IEC 60068-2-6	10 ... 500 Hz: 5g
• for railway applications acc. to DIN EN 61373	Category 1, Class B
operating frequency maximum	3 600 1/h
mechanical service life (switching cycles) typical	2 000 000
reference code acc. to IEC 81346-2	S
Ambient conditions	
• ambient temperature during operation	-25 ... +70 °C
• ambient temperature during storage	-40 ... +80 °C





environmental category during operation acc. to IEC 60721	3M6, 3S2, 3B2, 3C3, 3K6 (with relative air humidity of 10 ... 95 %)
---	---

Installation/ mounting/ dimensions	
height	57.7 mm
width	29.8 mm
shape of the installation opening	round
mounting diameter	22.3 mm
positive tolerance of installation diameter	0.4 mm
mounting height	14.4 mm
installation width	29.9 mm
installation depth	25.7 mm

Certificates/ approvals

General Product Approval	Declaration of Conformity	Test Certificates
  	Miscellaneous	

Marine / Shipping

Marine / Shipping	other
    	Confirmation

Further information

Information- and Downloadcenter (Catalogs, Brochures,...)
<https://www.siemens.com/ic10>
Industry Mall (Online ordering system)
<https://mall.industry.siemens.com/mall/en/en/Catalog/product?mlfb=3SU1000-3AB42-0AK0>
Cax online generator
<http://support.automation.siemens.com/WW/CAXorder/default.aspx?lang=en&mlfb=3SU1000-3AB42-0AK0>
Service&Support (Manuals, Certificates, Characteristics, FAQs,...)
<https://support.industry.siemens.com/cs/ww/en/ps/3SU1000-3AB42-0AK0>
Image database (product images, 2D dimension drawings, 3D models, device circuit diagrams, EPLAN macros, ...)
http://www.automation.siemens.com/bilddb/cax_de.aspx?mlfb=3SU1000-3AB42-0AK0&lang=en

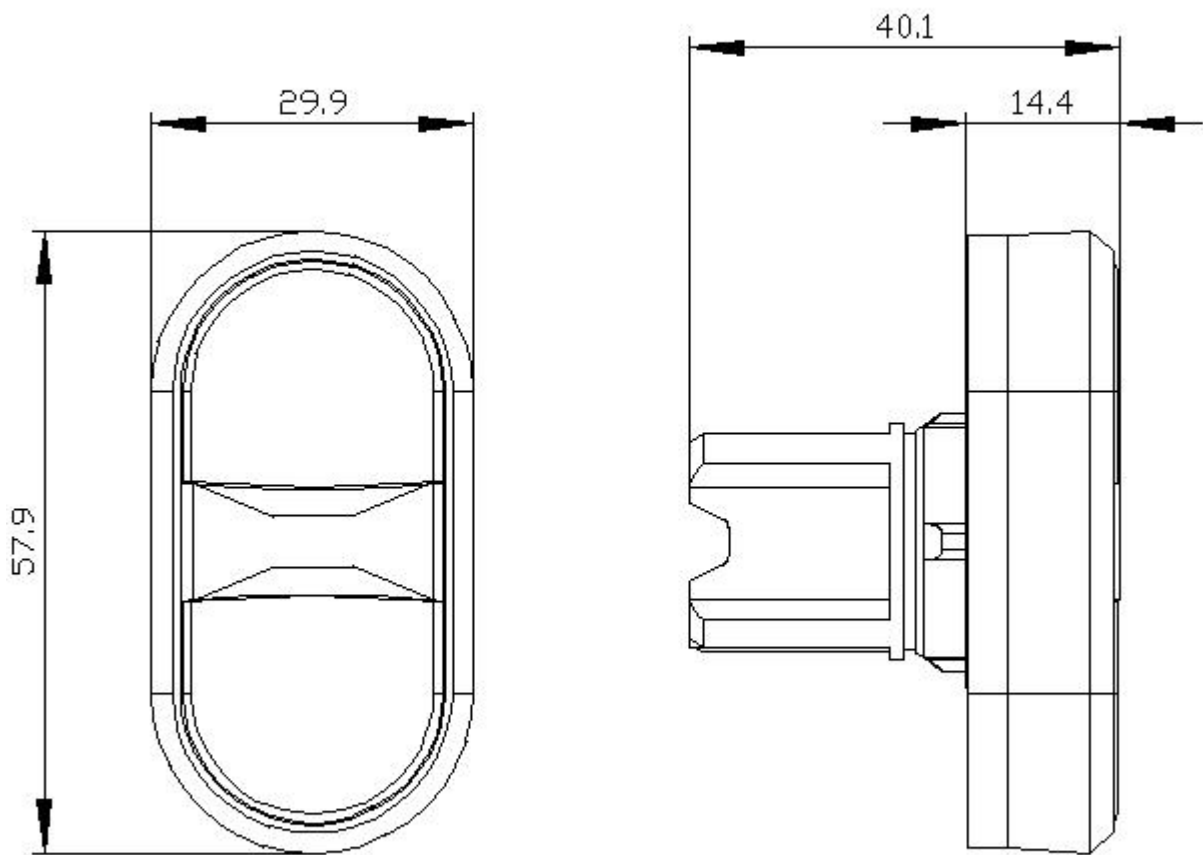

last modified:

8/31/2020 