

TF03 Long-Distance LiDAR  
UART/CAN  
Product Manual V1.2.2



## Specified Product

Product model: TF03 UART/CAN

Product Name: Long-Distance LiDAR

## Manufacturer

Company name: Benewake (Beijing) Co., Ltd.

Address: NO.28 Xixi Road, Haidian District, Beijing, PRC

## Copyright

The Copyright of this document is protected. All the rights involved herein belong to Benewake (Beijing) Co., Ltd. Any copy activity of this document, no matter in whole or in part, should be in conformity of the Copyright Law. The actives of modification, omission or translation of this document are not allowed unless a written permission from Benewake (Beijing) Co., Ltd.

All rights reserved © Benewake (Beijing) Co., Ltd.

## Foreword

Dear users:

Thanks for choosing Benewake products, and it's our pleasure to help you to solve any technical question.

For the purpose of offering a better operation experience to you, we hereby write this manual for an easier and simpler operation of our product, hoping to better solve the common problems you maybe meet. Please contact us if you have any questions.( [bw@benewake.com](mailto:bw@benewake.com))

This operation manual covers the product operation introduction and common problem solutions, but it is really hard to cover all the problems you maybe meet. So if you have any further questions or problems, please feel free to consult our technical support service ([support@benewake.com](mailto:support@benewake.com)). We will do our best to solve any problem related to the product. If you have any other good advice or suggestions, welcome to visit our official website and offer us your feedback there (<http://en.benewake.com/support>), and we are looking forwards to your participation.

We are Benewake who dedicated to making the best “Robotic Eyes” worldwide!

# Catalog

<b>1</b>	<b><u>ATTENTIONS</u></b>	<b>6</b>
1.1	ABOUT THIS DOCUMENT	6
1.2	USAGE OF PRODUCT	6
1.3	CONDITIONS WITH POTENTIAL PRODUCT FAILURE	6
<b>2</b>	<b><u>PRODUCT INTRODUCTION</u></b>	<b>7</b>
2.1	APPEARANCE OVERVIEW	7
2.2	PRODUCT STRUCTURE	7
2.3	PRINCIPLE OF MEASUREMENT	7
2.4	DETECTION ANGLE DESCRIPTIONS	8
<b>3</b>	<b><u>PHYSICAL INTERFACE</u></b>	<b>9</b>
3.1	DESCRIPTION OF LINE SEQUENCE AND CONNECTION	9
3.2	ELECTRICAL CHARACTERISTICS	10
<b>4</b>	<b><u>COMMUNICATION INTERFACE AND DATA FORMAT</u></b>	<b>11</b>
4.1	UART INTERFACE	11
4.2	CAN BUS	12
4.3	DESCRIPTIONS ON PARAMETER CONFIGURATION	13
4.3.1	FUNCTION OVERVIEW	13
4.3.2	COMMANDS	13
4.3.3	INSTRUCTIONS OF COMMAND EDITING	15
<b>5</b>	<b><u>QUICK TEST PROCEDURE</u></b>	<b>15</b>
5.1	REQUIRED TOOLS OF PRODUCT TEST	15
5.2	TEST PROCEDURE	16



**5.3 TEST EXAMPLE.....17**

5.3.1 TEST RANGE WITH DIFFERENT REFLECTIVITY .....17

5.3.2 ACCURACY OF DIFFERENT MATERIALS .....17

**6 CONFIGURATION SOFTWARE OF TF03 .....18**

**7 FAILURE REASONS AND TROUBLESHOOTING .....19**

**8 FAQ .....20**

**ATTACHMENT 1: REFLECTIVITY OF DIFFERENT MATERIALS.....21**



# 1 Attentions

## 1.1 About this Document

- This Manual provides information necessary for the use of this product.
- Please read this Manual carefully before using this product and make sure that you have fully understood its contents.

## 1.2 Usage of Product

- This product can only be maintained by qualified professionals and only the original spare parts can be used to ensure its performance and safety.
- The working temperature of the product is  $-25^{\circ}\text{C}\sim 60^{\circ}\text{C}$ ; please do not use it beyond this temperature range, so as to avoid risks.
- The storage temperature of the product is  $-40^{\circ}\text{C}\sim 85^{\circ}\text{C}$ ; please do not store it beyond this temperature range, so as to avoid risks.
- Do not open its enclosure for assembly or maintenance beyond this Manual; otherwise, it will affect the product performance.
- Do not twist the cable forcefully, so as to avoid damage to product.
- The product can't be aimed directly to the sun or another TF03, so as to avoid damage the detector by strong light. If there is such an application, please contact our technician.

## 1.3 Conditions with Potential Product Failure

- When the product transmitter and receiver lens are covered by dirt, there will be a risk of failures. Please keep the lens clean.
- The product will have a risk of failure when immersed completely in water. Do not use it underwater.
- When detecting objects with high reflectivity, such as mirrors and smooth tiles, the product may have a high risk of failures.

## 2 Product Introduction

### 2.1 Appearance Overview

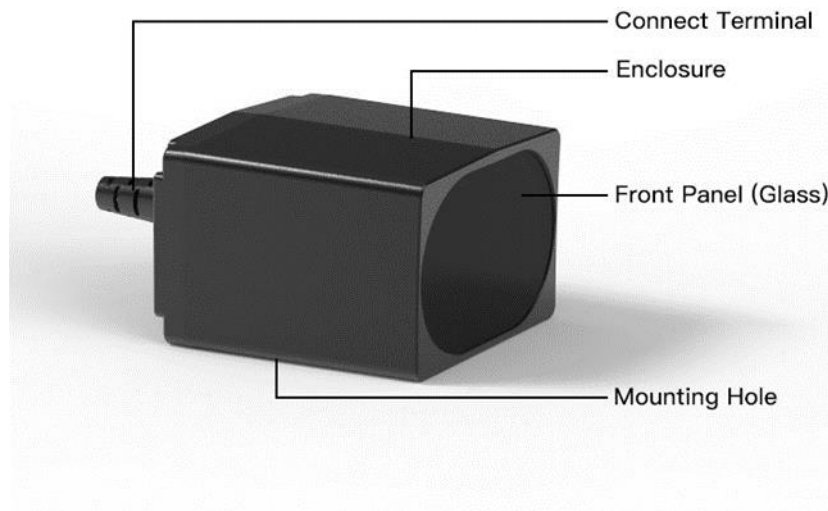

Figure 1 Appearance

### 2.2 Product Structure

The LiDAR mounting holes are applicable to M3 screws.

Note: The length of the screw entering the enclosure shall be no more than 3.5mm.

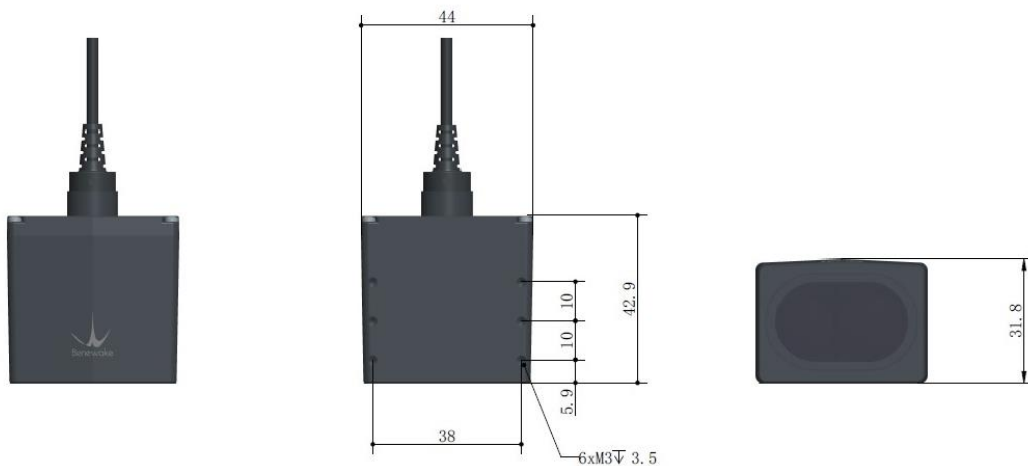

Figure 2 Dimension (Left 1: top; Left 2: bottom; Left 3: front; Unit: mm)

### 2.3 Principle of Measurement

TF03 is a single point LiDAR, which is based on Pulse Time of Flight (PTOF). It adopts an incoherent energy receiving mode, and the detection is mainly based on Pulse counting.

TF03 emits a narrow pulse laser, which is collimated by the transmitting lens to form a



collimated light, which enters the receiving system after being reflected by the measured target and is focused on the APD detector by the receiving lens. The time between the transmitted signal and the received signal is calculated through the circuit amplification and filtering, and the distance between TF03 and the measured target can be calculated through the speed of light.

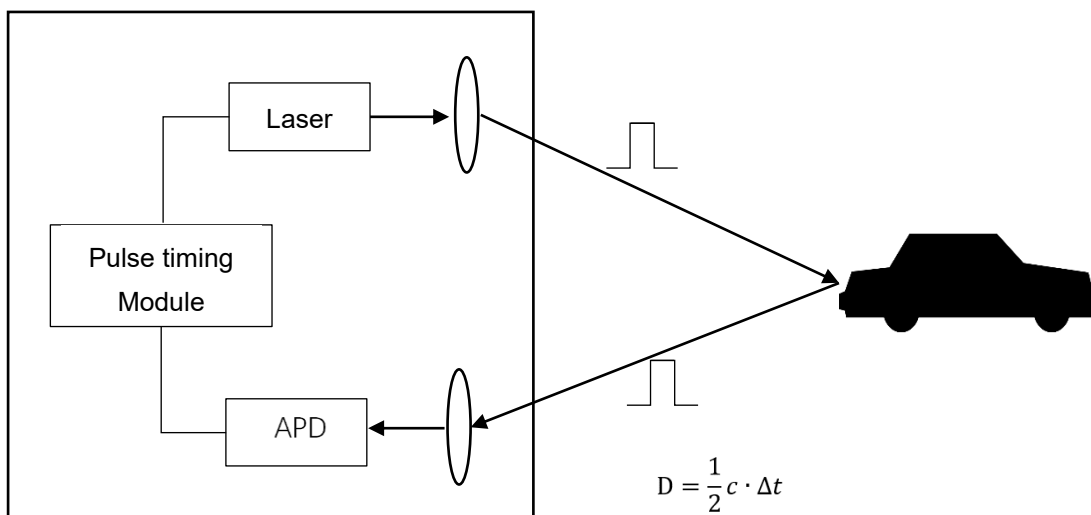

Figure 3 Principle of measurement

## 2.4 Detection angle descriptions

TF03 has a 0.5 degree detection angle and rectangular light spot, see Figure 4 for simulated diagrams of the light spot. Therefore, at different distances, the spot size, namely detecting range, is different as shown in Table 1.

Note: The side length of common objects detected should be greater than that of the detection range of TF03; When the side length of the detected object is less than that of the detection range, the LiDAR effective range will be reduced

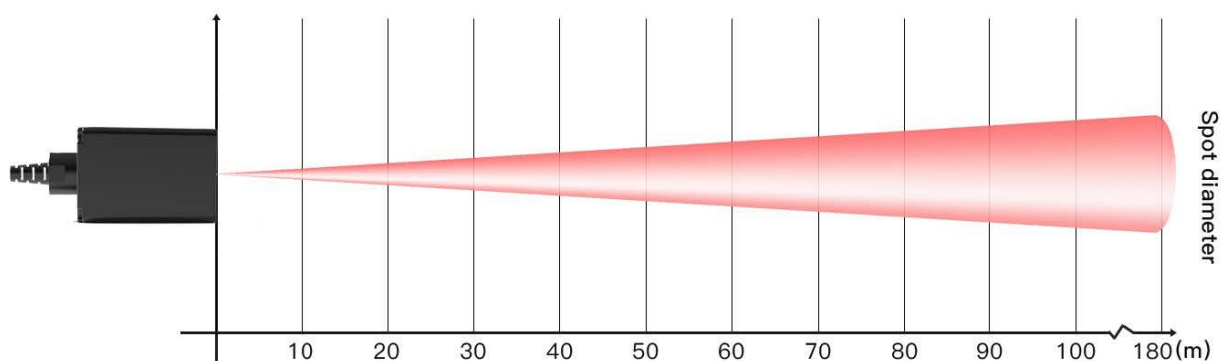
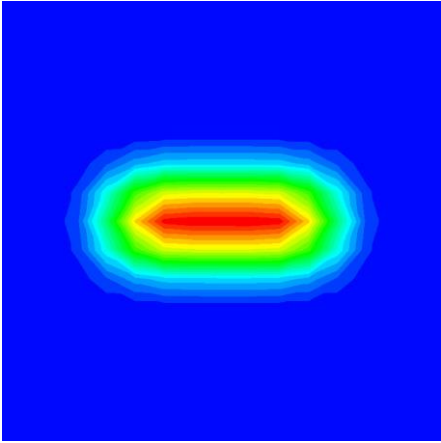
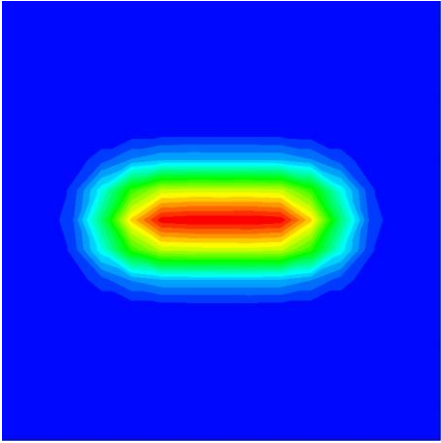
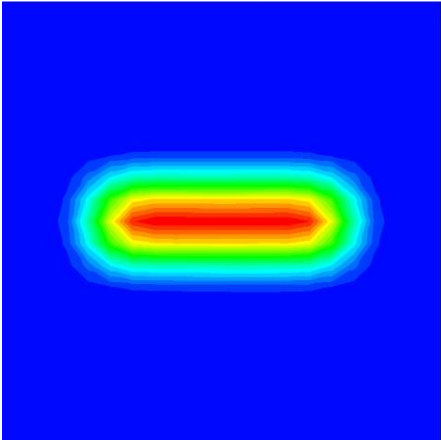
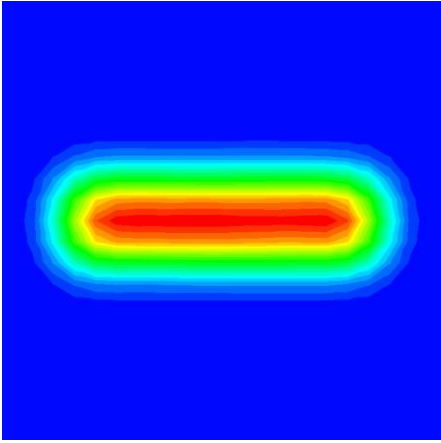

Figure 4 Detection angle of TF03





Table 1 Spot simulated diagrams and sizes at different distances

			
Spot 20m away	Size: 20cm*6cm	Spot 50m away	Size: 50cm*14cm
			
Spot 100m away	Size: 100cm*28cm	Spot 150m away	Size: 150cm*42cm

Note: In these pictures, color represents the light intensity distribution, the red is the strongest, the green is weak, the blue is the background. The spot size is the length and width of the green in the picture.

### 3 Physical Interface

New version of TF03-100/180 is released since August 2020, the physical interface is adjusted as follows:

- Bold cable, the size of single wire is changed from AWG30 to AWG 26
- Remove a wire, the amount of wire is 6 now, color is shown in Figure 5
- Add overvoltage and polarity protection, shown as Table 3

#### 3.1 Description of line sequence and connection

Terminal model: MH1.25-7P-W/B, size of single wire is AWG26, diameter of single wire is



0.404mm, cross-sectional area is 0.129mm<sup>2</sup>.

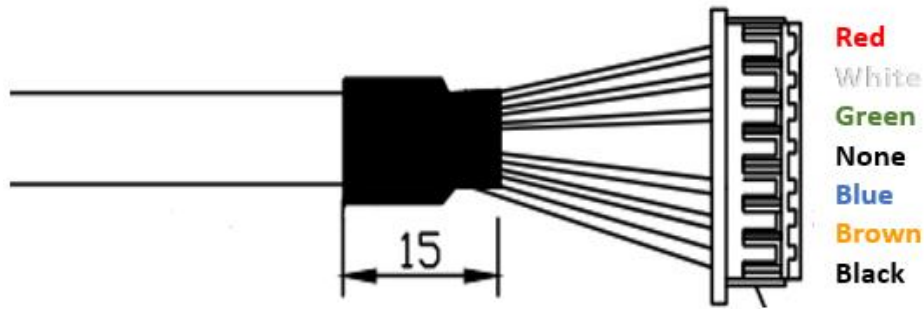

Figure 5 New Line Sequence of TF03

Table 2 Pin functions and connection instructions of TF03

No.	Color	Pin	Function
1	Red	VCC	Voltage Input
2	White	CAN_L	CAN
3	Green	CAN_H	CAN
4	N/A	N/A	N/A
5	Blue	TTL_RXD	UART receiver
6	Brown	TTL_TXD	UART transmitter
7	Black	GND	GND

Note: If UART is used, the TTL\_RXD and TTL\_TXD must be connected and not allowed to be left floating, So as not to be affected by electromagnetic interference.

### 3.2 Electrical Characteristics

New version has overvoltage and polarity protection.

Table 3 Main electrical parameters

Parameter	Typical value
Supply voltage	5V~24V
Average current	≤150mA
Average power consumption	≤1W
Overvoltage protection	300V
Polarity protection	200V



## 4 Communication interface and Data format

The standard version of TF03 supports UART and CAN communication interface. The default interface is UART. If necessary, the CAN mode can be set by sending command. Two interfaces cannot output simultaneously.

### 4.1 UART Interface

TF03 adopts UART interface, LVTTTL level is 0~3.3V. The specific communication interface is shown as below.

Table 4 Communication interface of UART

Item	Parameter
Communication interface	UART
Baud rate	115200
Data bit	8
Stop bit	1
Parity	None

The output data (hexadecimal numbers) of TF03 is shown in Table 5. Each data frame consists of 9 bytes and the data contains the distance and signal strength<sup>1</sup> information.

Table 5 TF03 UART data format

Data bit	Definition	Description
Byte0	Frame header	0x59
Byte1	Frame header	0x59
Byte2	DIST_L	DIST low 8-bits
Byte3	DIST_H	DIST high 8-bits
Byte4	Strength_L	Signal strength low 8-bits
Byte5	Strength_H	Signal strength high 8-bits
Byte6	Reserved bit	/
Byte7	Reserved bit	/

<sup>1</sup> New version of TF03 adds strength information. Strength value is between 0 and 3500, threshold of strength is 40, when strength is lower than 40, dist will output maximum value. When strength is between 40 and 1200, dist is more reliable. When there is a high reflectivity object, strength will be over 1500.



Byte8	Checksum	Low 8 bits of Checksum bit. Checksum = Byte0 + Byte2+...+Byte7
-------	----------	---

## 4.2 CAN BUS

The CAN communication protocol of TF03 can be customized according to the customer's demand. The CAN baud rate and ID and frame format can be modified. The contents of the interface are shown in Table 6.

Table 6 Communication interface of CAN

Item	Content
Communication protocol	CAN
Baud rate	1M
Receive ID	0x3003
Transmit ID	0x3
Frame format	The default transmit frame is standard frame. Receive frame supports standard and extended frame.

The output data (hexadecimal numbers) of TF03 CAN is shown in Table 7. Each data frame consists of 6 bytes and the data contains the distance and signal strength<sup>2</sup> information.

Table 7 TF03 CAN data format

Data bit	Definition	Description
Byte0	DIST_L	DIST low 8-bits
Byte1	DIST_H	DIST high 8-bits
Byte2	Strength_L	Signal strength low 8-bits
Byte3	Strength_H	Signal strength high 8-bits
Byte4	Reserved bit	/
Byte5	Reserved bit	/

<sup>2</sup> Under CAN interface, when the frame rate is under 1000Hz, TF03 can output DIST and Strength at the same time, but when the frame rate is over 1000Hz, TF03 can only output DIST.



## 4.3 Descriptions on parameter configuration

### 4.3.1 Function Overview

To meet the demand of different customers, parameters can be set by yourselves. Parameters, such as data format, frame rate could be changed by sending command. Parameter will be stored in flash after configured successfully and customers don't need to configure again when restart.

Please change the parameter according to certain demands and do not frequently try irrelevant instructions. Please configure the product according to the demands of the manual and never send unstated command.

The Format of Command is:

Byte	Definition	Description
Byte0	Head	Fixed to 0x5A
Byte1	Len	The length of the entire instruction frame (unit: Byte)
Byte2	ID	Identifies the function of each instruction
Byte3~ByteN-2	Payload	Different meanings and lengths in different ID instruction frames
ByteN-1	Check sum	the lower 8 bits of the Len-1 byte data

### 4.3.2 Commands

Table 8 Commands list of TF03

Function	Command	Response	Remark	Default setting
Obtain firmware version	5A 04 01 5F	5A 07 01 V1 V2 V3 SU	The version number V3.V2.V1 SU is check sum	/
System reset	5A 04 02 60	Success: 5A 05 02 00 61 Fail: no response over 1s	/	/
Frame rate <sup>3</sup>	5A 06 03 LL HH SU	Success: 5A 06 03 LL HH SU Fail: no response over 1s	/	100fps

<sup>3</sup> New version of TF03 can only support (1~9) \*10<sup>N</sup>, N values for 0, 1, 2, 3. If other value is set, TF03 will set it to 100Hz. If 10000Hz is necessary, please contact our technician.



Output switch	Enable: 5A 05 07 01 67 Disable: 5A 05 07 00 66	Success: same as downward command Fail: no response over 1s	/	Enable
Trigger command	5A 04 04 62	Data frame	/	/
Output format	5A 05 05 LL SU	Success: 5A 05 05 LL SU Fail: no response over 1s	LL: format shown as below, 00: ASCII (Reserved) 01: Binary output	Binary output
UART baud rate <sup>4</sup>	5A 08 06 H1 H2 H3 H4 SU	Success: 5A 08 06 H1 H2 H3 H4 SU Fail: no response over 1s	See chapter 4.3.3	115200
Enable checksum	Enable: 5A 05 08 01 68 Disable: 5A 05 08 00 67	Success: same as command Fail: no response over 1s	/	Enable
Restore factory settings	5A 04 10 6E	Success: 5A 05 10 00 6F Fail: 5A 05 10 ER SU	Fail(when ER is not 0)	/
Save settings	5A 04 11 6F	Success: 5A 05 11 00 70 Fail: 5A 05 11 ER SU	same as above	/
Over range threshold value	5A 06 4F LL HH SU	Success: 5A 05 4F 00 AE Fail: no response over 1s	Unit: cm See chapter 4.3.3	18000
Transmit CAN ID	5A 08 50 H1 H2 H3 H4 SU	Success: 5A 05 50 00 AF Fail: no response over 1s	See chapter 4.3.3 Please configure the legal CAN ID. Unexpected results may occur for illegal ID	0x3
Receive CAN ID	5A 08 51 H1 H2 H3 H4 SU	Success: 5A 05 51 00 B0 Fail: no response over 1s	See chapter 4.3.3 Please configure the legal CAN ID. Unexpected results may occur for illegal ID	0x3003
CAN baud rate <sup>5</sup>	5A 08 52 H1 H2 H3 H4 SU	Success: 5A 05 52 00 B1 Fail: no response over 1s	See chapter 4.3.3	1000000
CAN transmit frame type	Standard frame: 5A 05 5D 00 BC Extended frame: 5A 05 5D 01 BD	Success: 5A 05 5D 00 BC Fail: no response over 1s	/	Standard frame

<sup>4</sup> Baud rate of UART can be set to 9600, 14400, 19200, 38400, 56000, 57600, 115200, 128000, 230400, 256000, 460800, 500000, 512000, 600000, 750000, 921600 and 1000000, if other value is set, TF03 will set it to 115200.

<sup>5</sup> Baud rate of CAN interface can be set to 1M, 800K, 666K, 500K, 400K, 250K, 200K, 125K, 100K, 83330, 80000, 66660, 50000, 40000, 33330, 20000, if other value is set, TF03 will set it to 1M.



Communication interface	UART: 5A 05 45 01 A5 CAN: 5A 05 45 02 A6	Success: 5A 05 45 00 A4 Fail: no response over 1s	/	UART
Rain-fog algorithm	Enable: 5A 05 64 00 C3 Disable: 5A 05 64 01 C4	Success: 5A 05 64 00 C3 Fail: no response over 1s	/	Enable
Offset configuration <sup>6</sup>	5A 06 69 LL HH SU	Success: 5A 05 69 00 C8 Fail: no response over 1s	Unit: cm See chapter 4.3.3	0

### 4.3.3 Instructions of command editing

To send certain command to TF03, these steps should be followed:

- Change value of parameter to HEX
- Put the HEX value to certain command
- Calculate the checksum, put low 8-bits into command





For example, changing the baud rate to 460800, first, changing 460800 to HEX, we can get 0x00 07 08 00, then we can get this command-5A 08 06 00 08 07 00 77.

## 5 Quick Test Procedure

### 5.1 Required Tools of Product Test

Note: the product package contains only TF03 and factory certificate, other accessories are prepared by yourself. If you need TTL-USB convert board, please contact sales or technical support. The UART version needs a TTL-USB board when connected with computer. Tools and method are shown as below.

Table 9 Tools of test

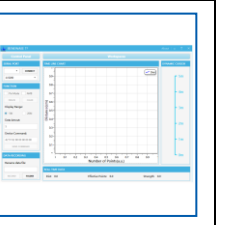
				
TF03 (UART)	TTL-USB Board	USB Cable	PC	TF display application

<sup>6</sup> “Offset configuration” can be used for secondary calibration of distance, for example, when dist is 195cm and you want LiDAR outputs 200cm, you can set offset value to 5cm. This function is supported from v1.11.3 firmware version.



## 5.2 Test procedure

### 1) Download the TF display application

Please download the TF display application from <http://en.benewake.com/support>

Note: Please close the antivirus software before unpacking the TF display application, otherwise the files will be deleted as viruses. The TF display application currently only supports running on the Windows system. See Attachment 1: Instruction of TF Series PC Display Software.

### 2) Connecting

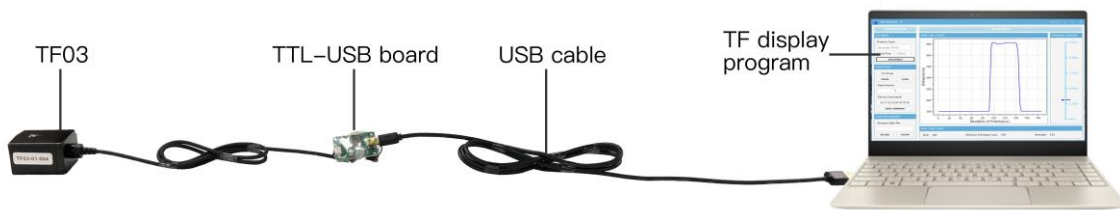

Figure 6 Diagram of connection

As Figure 6 shown, connect 『TF03』 and 『TTL- USB board』 and 『USB cable』 , ensure no looseness, then connect 『USB cable』 with 『computer』 .

### 3) TF display software connection and reading

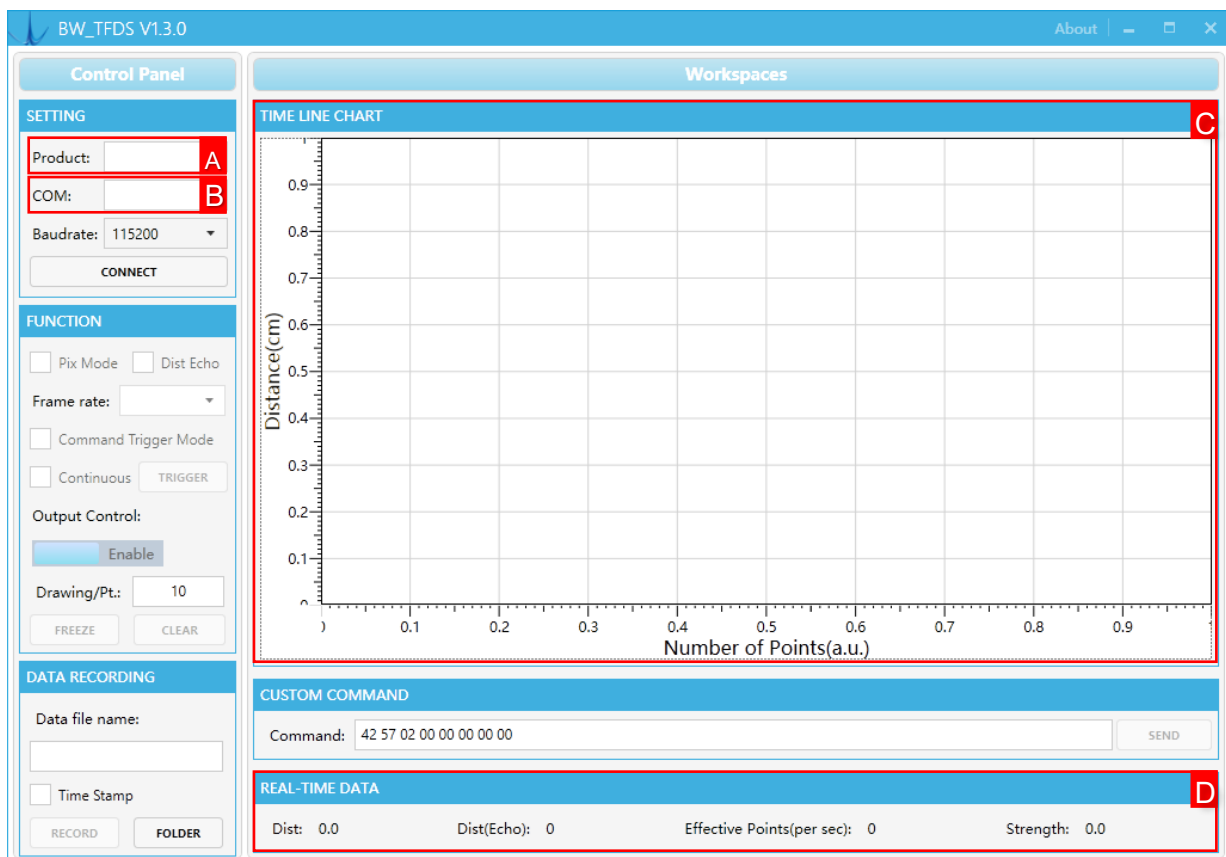

Figure 7 The interface of TF display software





As shown in Figure 7, test steps are shown as below:

- Open the TF display application
- Select product model 『TF03』 in area A
- Select serial port number in area B.
- Click 『CONNECT』 to establish the communication.
- After connected successfully, continuous data curve will be shown in the area C 『TIME LINE CHART』 and area D 『REAL TIME DATA』 will display the current distance (Unit: cm) and frame rate (Effective Points).

## 5.3 Test Example

### 5.3.1 Test Range with Different Reflectivity

As shown in Figure 8, red and blue curves represent the relationship between range performance of TF03-180 and reflectivity of the target under different ambient light situation.

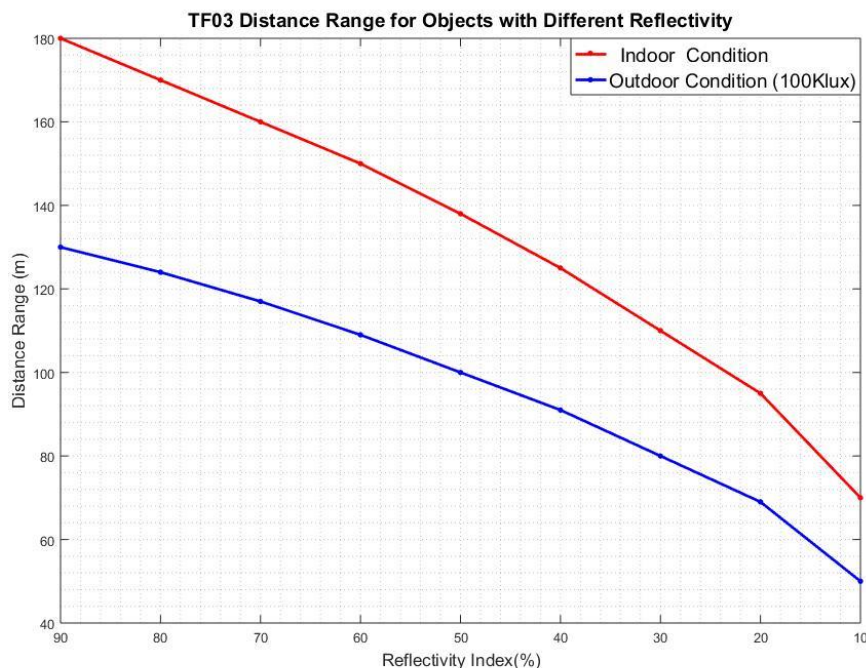

Figure 8 The relationship between range performance of TF03-180 and reflectivity

### 5.3.2 Accuracy of Different Materials

The accuracy of TF03 at different distances and reflectivity is shown in Figure 9. Two typical background boards(black and white) are selected. The reflectivity of whiteboard is 90% and blackboard is 10%.



TF03 Accuracy Results For Targets With Different Reflectivity At Varying Distance

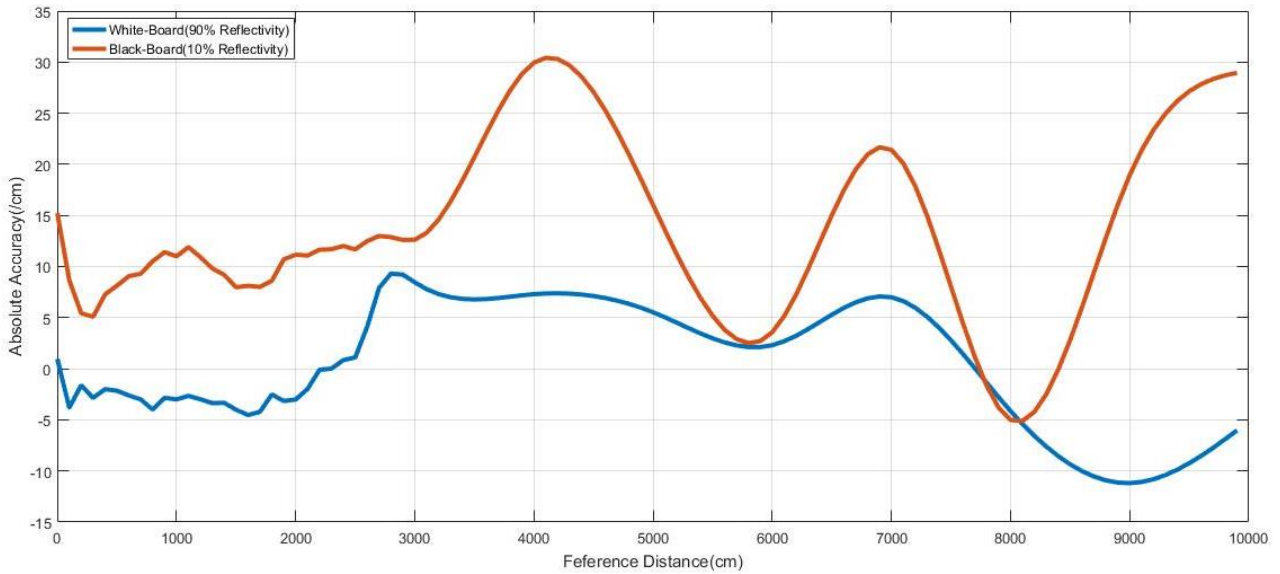

Figure 9 Error curves of TF03 at different distance and reflectivity  
(Test environment: 25°C, indoor without ambient light)

## 6 Configuration Software of TF03

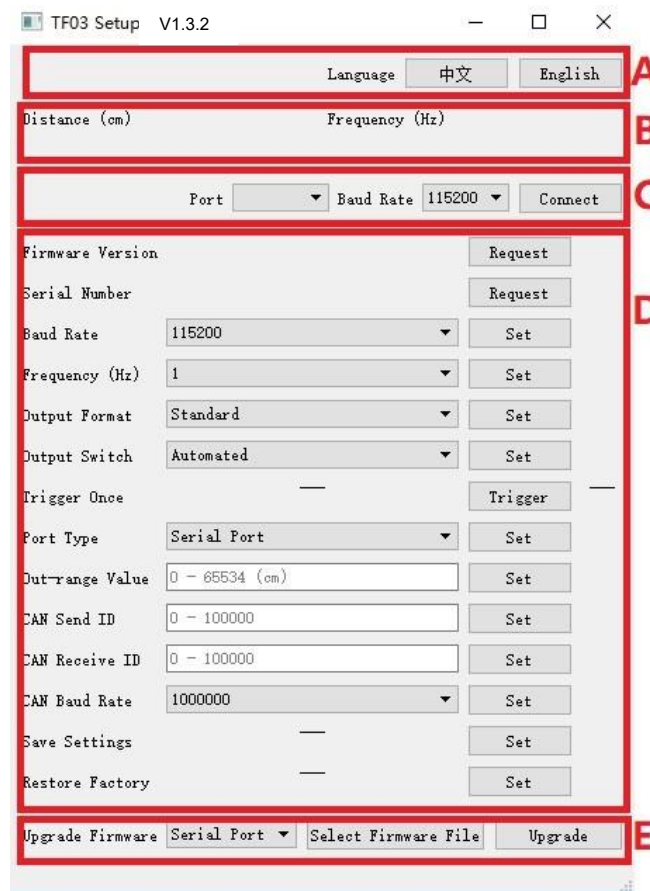

Figure 10 The interface of configuration software



Interface of configuration software is shown above.

- 1) After TF03 is connected to the computer, select the correct serial port number and baud rate in Zone C manually and click the 『Connect』 button to establish communication between the software and TF03.
- 2) After communication is established successfully, zone B will display the distance and frequency of data. When no data is received over two seconds, the distance and frequency display will disappear.
- 3) Zone D is dedicated to function configuration and its third column lists the buttons for sending instructions. After clicking such buttons, the configuration software will send commands and wait for reply from TF03. When no reply is received for a long time, 『No Response』 will be displayed on the right side of the instruction-sending buttons. Please note that in order to ensure that TF03 reply instructions can be obtained normally, lower the 『frame rate』 or set the 『output mode』 as 『instruction trigger』 before configuration. If the changed parameters need to be saved, click 『Save Configuration』 before power down TF03.
- 4) Zone E is dedicated to firmware upgrade, BootLoader can be used to upgrade the firmware.

## 7 Failure reasons and troubleshooting

- 1) Under normal operation, TF03 sometimes will output 18000(cm).

**Reasons:** The actual distance measured is beyond the range of TF03, TF03 will output 18000.

**Troubleshooting:** Treat 18000 as an exception value. When you receive 18000 from TF03, don't adopt this data.

- 2) No data output after TF03 is connected to the TF display application.

**Reason I :** The computer uses and operating system other than Windows.

**Troubleshooting :** Currently, the TF display application can only support the Windows operating system. Use a computer with the Windows system installed.

**Reason II :** Poor connection between TF03 and computer.

**Troubleshooting :** Please confirm that TF03 is correctly and reliably connected to the computer, and ensure that the cables and adapter board work properly.

3) TF03 has a poor range performance in some cases.

**Reason:** TF03 bases on the time-of-flight (TOF) principle, to achieve ranging by calculating the round-trip time of flight of laser pulses. The intensity of ambient light or the reflectivity of objects under testing is different, and thus will increase the intensity of ambient noise or return light intensity. Therefore, the ranging performance of TF03 varies with different ambient light intensities and reflectivity.

**Troubleshooting:** Under different ambient light intensity and reflectivity of objects, having different range performance is a normal phenomenon and does not affect the accuracy or repeatability.

## 8 FAQ

**Q1:** Can the FOV (spot) of TF03 be increased or decreased?

**A1:** Generally, this is a customized demand. You need to contact our sale colleague for further details. FOV is determined at the beginning of product design. Determination of FOV is also related to the optical system and the product structure. Therefore, it cannot be easily changed, and needs to be customized.

**Q2:** Can I change the frequency of data output? Can TF03 output switching values?

**A2:** Yes, customization of parameter configuration and adjustment of output modes have been enabled for TF03. However, switching values have to be customized according to requirement. You may consult our sales colleague or technical support for further details.

**Q3:** Can TF03 work normally under raining, snowing and fog?

**A3:** TF03 has a firmware version which support this function. Contact our sale colleague or technical support for firmware upgrade. The algorithm is turned on by default in V1.11.15.

## Attachment 1: Reflectivity of Different Materials

The reflectivity of different materials is listed below, ranging from low to high. According to the test target and the corresponding reflectivity, we can measure whether the range of TF03 and other parameters meet the requirements.

No.	Materials	Reflectivity
1	black foam rubber	2.4%
2	black cloth	3%
3	black rubber	4%
4	Coal (varies from coal to coal)	4~8%
5	Black car paint	5%
6	Black paper	10%
7	opaque black plastic	14%
8	Clean rough board	20%
9	newspapers	55%
10	translucent plastic bottles	62%
11	packing case cardboard	68%
12	Clean pine	70%
13	opaque white plastic	87%
14	white card	90%
15	Kodak standard whiteboard	100%
16	Unpolished white metal surface	130%
17	Shiny light metal surface	150%
18	stainless steel	200%
19	Reflective board, reflective adhesive tape	>300%

