

MOLD CAVITY ID FOR REFERENCE ONLY

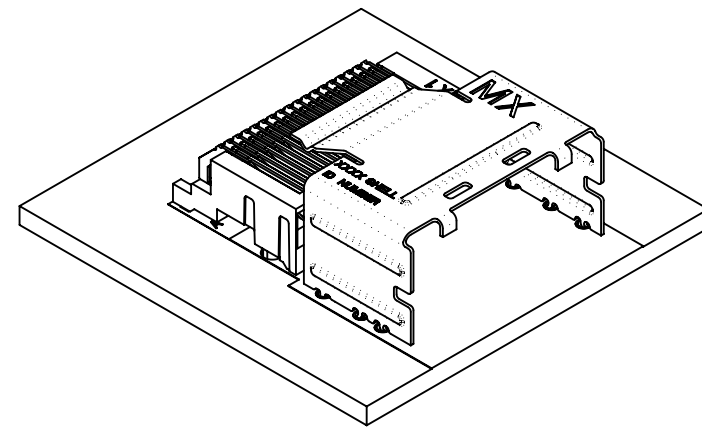

NOTES:

- MATERIAL:
 - CONNECTOR: HOUSING - HIGH TEMPERATURE THERMOPLASTIC GLASS FILLED, UL 94V-0, BLACK; TERMINALS - COPPER ALLOY
 - SHELL: SILVER NICKEL, C770, THICKNESS: 0.250/0.254
- FINISH:
 - CONNECTOR OPTION 1: CONTACT AREA - 0.38µm MIN GOLD OVER 2.54 µm NICKEL; SOLDER FOOT AREA - 2.54-5.09µm TIN OVER 1.27 µm NICKEL
 - CONNECTOR OPTION 2: CONTACT AREA - 0.76µm MIN GOLD OVER 2.54 µm NICKEL; SOLDER FOOT AREA - 2.54-5.09µm TIN OVER 1.27 µm NICKEL
- TERMINAL SOLDER FEET TO BE COPLANAR WITHIN 0.10 MEASURED FROM FRONT HOUSING STAND OFF (DATUM C)
- DATE CODE: 4 DIGIT (3 DIGIT DAY, 1 DIGIT YEAR) CONNECTOR ONLY
- CIRCUIT IDENTIFIER: SEE APPROPRIATE INDUSTRY SPECIFICATION FOR LOCATION OF PIN 1.
- TO BE USED WITH THE FOLLOWING CABLE SERIES: 79575/74563/79576/74573/79536/74562/74586
- PACKAGED PER PACKAGING SPECIFICATION: PK-75783-001
- CONFORMS TO PRODUCT SPECIFICATION: PS-75783-001
- PROCESS PER APPLICATION SPECIFICATION: AS-75783-001
- THIS PART CONFORMS TO CLASS C REQUIREMENTS OF COSMETIC SPEC PS-45499-002

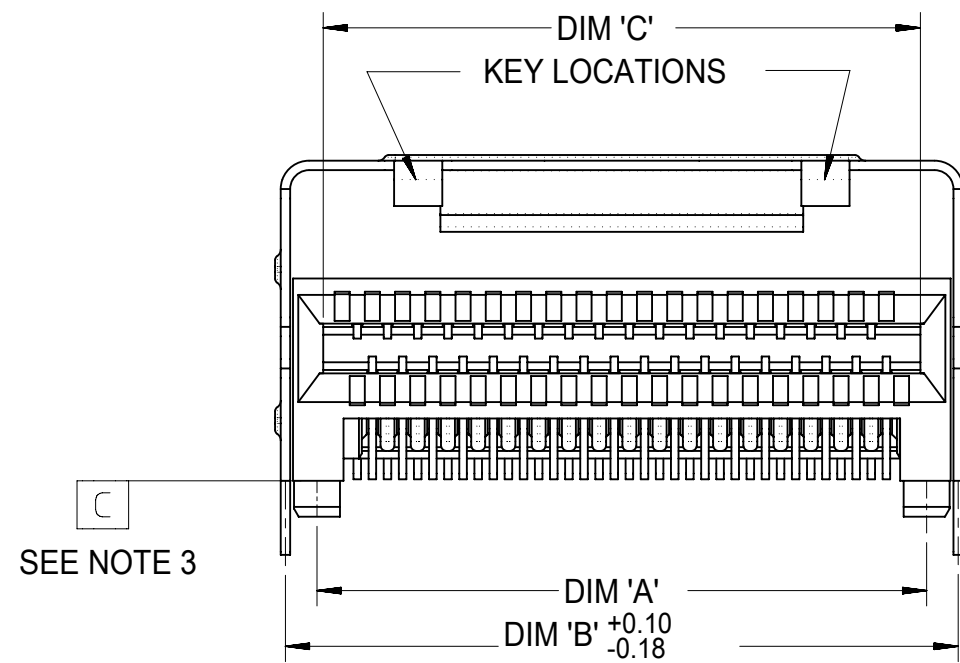

SEE NOTE 3

36 CIRCUIT RETENTION FIT SHELL OPTION SHOWN

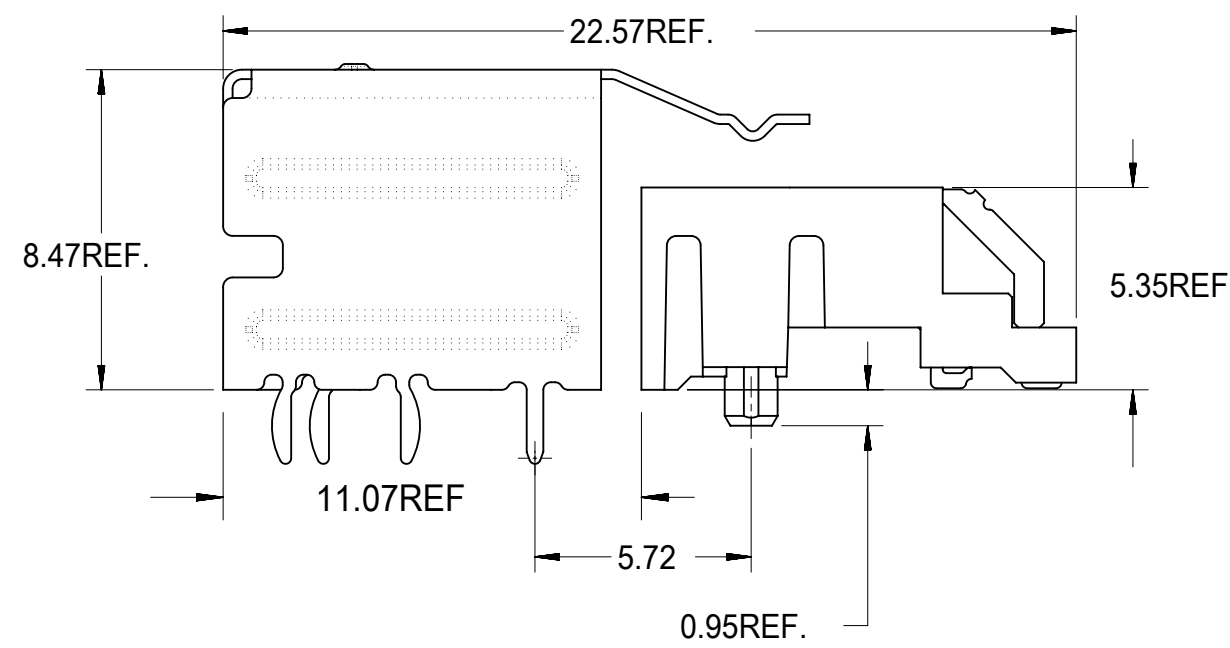

CIRCUIT SIZE	DIM 'A'	DIM 'B'	DIM 'C'
26	12.00	13.80	11.80
36	16.00	17.80	15.80
50	21.60	23.40	21.40
68	28.80	30.60	28.60

SYMBOLS		THIS DRAWING CONTAINS INFORMATION THAT IS PROPRIETARY TO MOLEX ELECTRONIC TECHNOLOGIES, LLC AND SHOULD NOT BE USED WITHOUT WRITTEN PERMISSION	
DIMENSION UNITS	SCALE	CURRENT REV DESC:	
mm	1:1	EC NO: 173961	
GENERAL TOLERANCES (UNLESS SPECIFIED)		DRWN: RWHIPPLE	2018/03/19
ANGULAR TOL ± 0.5°		CHK'D: SMILLER	2018/03/21
4 PLACES ±		APPR: SMILLER	2018/03/21
3 PLACES ±		INITIAL REVISION:	
2 PLACES ± 0.13		DRWN: KCALLAGHAN	2016/07/21
1 PLACE ± 0.25		APPR: TMCLELL	2016/08/24
0 PLACES ±		THIRD ANGLE PROJECTION	
DRAFT WHERE APPLICABLE MUST REMAIN WITHIN DIMENSIONS		DRAWING	SERIES
		C-SIZE	75783
		MATERIAL NUMBER	CUSTOMER
		SEE TABLE	GENERAL MARKET
		DOC TYPE	DOC PART
		PSD	001
		REVISION	F
		SHEET NUMBER	1 OF 13

DOCUMENT STATUS	P1	RELEASE DATE	2018/03/21	15:54:34
12	11	10	9	8

RIGHT ANGLE CONNECTOR WITH SHELL PCB FOOT PRINT DESCRIPTIONS

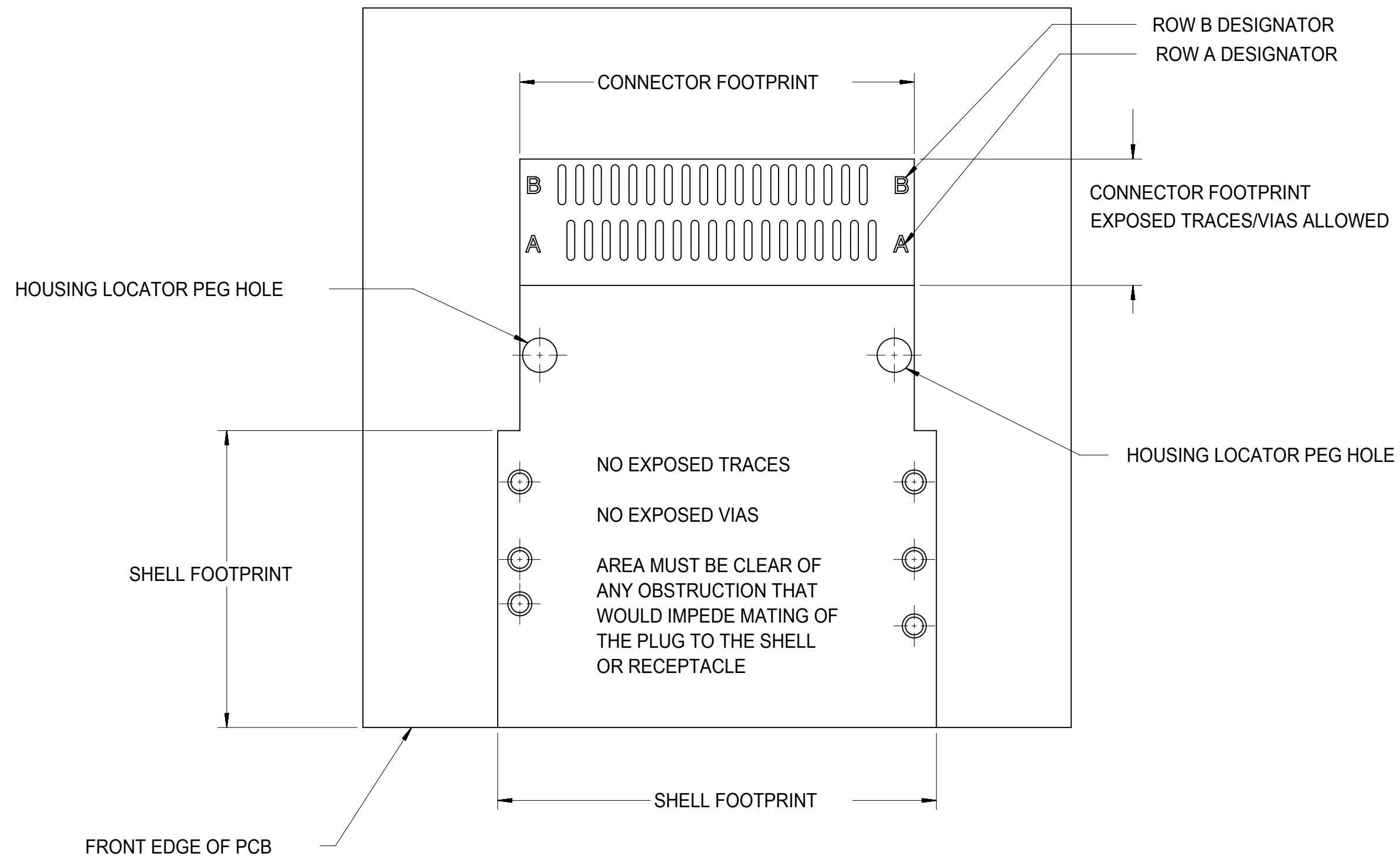

36 CIRCUIT SHOWN

NOTE: IF RECEPTACLE AND SHELL ARE NOT PLACED AT EDGE OF PCB AS SHOWN, ADDITIONAL CLEARANCE IS NEEDED FOR BODY OF PLUG AND CABLE

THIS DRAWING CONTAINS INFORMATION THAT IS PROPRIETARY TO MOLEX ELECTRONIC TECHNOLOGIES, LLC AND SHOULD NOT BE USED WITHOUT WRITTEN PERMISSION																																																																																																																									
SYMBOLS	DIMENSION UNITS	SCALE	CURRENT REV DESC:																																																																																																																						
▽ = 0	mm	1:1	<table style="width: 100%; border: none;"> <tr> <td colspan="2">EC NO: 173961</td> <td colspan="5" rowspan="3" style="text-align: center; vertical-align: middle;"> <div style="font-size: 2em; font-weight: bold; margin-bottom: 10px;">molex</div> I-PASS R/A CONNECTOR INTERNAL ASSY W/SHELL 0.8MM PITCH I/O </td> </tr> <tr> <td colspan="2">DRWN: RWHIPPLE</td> <td>2018/03/19</td> </tr> <tr> <td colspan="2">CHK'D: SMILLER</td> <td>2018/03/21</td> </tr> <tr> <td colspan="2">APPR: SMILLER</td> <td>2018/03/21</td> <td colspan="4" style="text-align: center;">PRODUCT CUSTOMER DRAWING</td> <td colspan="2"></td> </tr> <tr> <td colspan="3">GENERAL TOLERANCES (UNLESS SPECIFIED)</td> <td colspan="7" rowspan="3" style="vertical-align: top;"> <table style="width: 100%; border: none;"> <tr> <td colspan="2">INITIAL REVISION:</td> <td colspan="5" rowspan="3" style="text-align: center; vertical-align: middle;"> <table border="1" style="width: 100%; border-collapse: collapse;"> <tr> <td style="width: 30%;">DOCUMENT NUMBER</td> <td style="width: 10%;">DOC TYPE</td> <td style="width: 10%;">DOC PART</td> <td style="width: 10%;">REVISION</td> </tr> <tr> <td style="text-align: center; font-size: 1.2em;">SD-75783-001</td> <td style="text-align: center;">PSD</td> <td style="text-align: center;">001</td> <td style="text-align: center;">F</td> </tr> </table> </td> </tr> <tr> <td colspan="2">DRWN: KCALLAGHAN</td> <td>2016/07/21</td> </tr> <tr> <td colspan="2">APPR: TMCLELL</td> <td>2016/08/24</td> </tr> </table> </td> </tr> <tr> <td colspan="3">ANGULAR TOL ± 0.5°</td> <td colspan="7" rowspan="3" style="vertical-align: top;"> <table style="width: 100%; border: none;"> <tr> <td colspan="2">MATERIAL NUMBER</td> <td colspan="3">CUSTOMER</td> <td colspan="2">SHEET NUMBER</td> </tr> <tr> <td colspan="2">SEE TABLE</td> <td colspan="3">GENERAL MARKET</td> <td colspan="2">3 OF 13</td> </tr> </table> </td> </tr> <tr> <td colspan="3">4 PLACES ±</td> </tr> <tr> <td colspan="3">3 PLACES ±</td> </tr> <tr> <td colspan="3">2 PLACES ± 0.13</td> </tr> <tr> <td colspan="3">1 PLACE ± 0.25</td> </tr> <tr> <td colspan="3">0 PLACES ±</td> </tr> <tr> <td colspan="3">DRAFT WHERE APPLICABLE MUST REMAIN WITHIN DIMENSIONS</td> <td colspan="2" style="text-align: center;">THIRD ANGLE PROJECTION</td> <td colspan="2" style="text-align: center;">DRAWING</td> <td colspan="2" style="text-align: center;">SERIES</td> <td colspan="1" style="text-align: center;">C-SIZE</td> </tr> <tr> <td colspan="3"></td> <td colspan="2" style="text-align: center;"> </td> <td colspan="2" style="text-align: center;"> </td> <td colspan="2" style="text-align: center;"> 75783 </td> <td colspan="1"></td> </tr> </table>							EC NO: 173961		<div style="font-size: 2em; font-weight: bold; margin-bottom: 10px;">molex</div> I-PASS R/A CONNECTOR INTERNAL ASSY W/SHELL 0.8MM PITCH I/O					DRWN: RWHIPPLE		2018/03/19	CHK'D: SMILLER		2018/03/21	APPR: SMILLER		2018/03/21	PRODUCT CUSTOMER DRAWING						GENERAL TOLERANCES (UNLESS SPECIFIED)			<table style="width: 100%; border: none;"> <tr> <td colspan="2">INITIAL REVISION:</td> <td colspan="5" rowspan="3" style="text-align: center; vertical-align: middle;"> <table border="1" style="width: 100%; border-collapse: collapse;"> <tr> <td style="width: 30%;">DOCUMENT NUMBER</td> <td style="width: 10%;">DOC TYPE</td> <td style="width: 10%;">DOC PART</td> <td style="width: 10%;">REVISION</td> </tr> <tr> <td style="text-align: center; font-size: 1.2em;">SD-75783-001</td> <td style="text-align: center;">PSD</td> <td style="text-align: center;">001</td> <td style="text-align: center;">F</td> </tr> </table> </td> </tr> <tr> <td colspan="2">DRWN: KCALLAGHAN</td> <td>2016/07/21</td> </tr> <tr> <td colspan="2">APPR: TMCLELL</td> <td>2016/08/24</td> </tr> </table>							INITIAL REVISION:		<table border="1" style="width: 100%; border-collapse: collapse;"> <tr> <td style="width: 30%;">DOCUMENT NUMBER</td> <td style="width: 10%;">DOC TYPE</td> <td style="width: 10%;">DOC PART</td> <td style="width: 10%;">REVISION</td> </tr> <tr> <td style="text-align: center; font-size: 1.2em;">SD-75783-001</td> <td style="text-align: center;">PSD</td> <td style="text-align: center;">001</td> <td style="text-align: center;">F</td> </tr> </table>					DOCUMENT NUMBER	DOC TYPE	DOC PART	REVISION	SD-75783-001	PSD	001	F	DRWN: KCALLAGHAN		2016/07/21	APPR: TMCLELL		2016/08/24	ANGULAR TOL ± 0.5°			<table style="width: 100%; border: none;"> <tr> <td colspan="2">MATERIAL NUMBER</td> <td colspan="3">CUSTOMER</td> <td colspan="2">SHEET NUMBER</td> </tr> <tr> <td colspan="2">SEE TABLE</td> <td colspan="3">GENERAL MARKET</td> <td colspan="2">3 OF 13</td> </tr> </table>							MATERIAL NUMBER		CUSTOMER			SHEET NUMBER		SEE TABLE		GENERAL MARKET			3 OF 13		4 PLACES ±			3 PLACES ±			2 PLACES ± 0.13			1 PLACE ± 0.25			0 PLACES ±			DRAFT WHERE APPLICABLE MUST REMAIN WITHIN DIMENSIONS			THIRD ANGLE PROJECTION		DRAWING		SERIES		C-SIZE								75783		
EC NO: 173961		<div style="font-size: 2em; font-weight: bold; margin-bottom: 10px;">molex</div> I-PASS R/A CONNECTOR INTERNAL ASSY W/SHELL 0.8MM PITCH I/O																																																																																																																							
DRWN: RWHIPPLE										2018/03/19																																																																																																															
CHK'D: SMILLER										2018/03/21																																																																																																															
APPR: SMILLER		2018/03/21	PRODUCT CUSTOMER DRAWING																																																																																																																						
GENERAL TOLERANCES (UNLESS SPECIFIED)			<table style="width: 100%; border: none;"> <tr> <td colspan="2">INITIAL REVISION:</td> <td colspan="5" rowspan="3" style="text-align: center; vertical-align: middle;"> <table border="1" style="width: 100%; border-collapse: collapse;"> <tr> <td style="width: 30%;">DOCUMENT NUMBER</td> <td style="width: 10%;">DOC TYPE</td> <td style="width: 10%;">DOC PART</td> <td style="width: 10%;">REVISION</td> </tr> <tr> <td style="text-align: center; font-size: 1.2em;">SD-75783-001</td> <td style="text-align: center;">PSD</td> <td style="text-align: center;">001</td> <td style="text-align: center;">F</td> </tr> </table> </td> </tr> <tr> <td colspan="2">DRWN: KCALLAGHAN</td> <td>2016/07/21</td> </tr> <tr> <td colspan="2">APPR: TMCLELL</td> <td>2016/08/24</td> </tr> </table>							INITIAL REVISION:		<table border="1" style="width: 100%; border-collapse: collapse;"> <tr> <td style="width: 30%;">DOCUMENT NUMBER</td> <td style="width: 10%;">DOC TYPE</td> <td style="width: 10%;">DOC PART</td> <td style="width: 10%;">REVISION</td> </tr> <tr> <td style="text-align: center; font-size: 1.2em;">SD-75783-001</td> <td style="text-align: center;">PSD</td> <td style="text-align: center;">001</td> <td style="text-align: center;">F</td> </tr> </table>					DOCUMENT NUMBER	DOC TYPE	DOC PART	REVISION	SD-75783-001	PSD	001	F	DRWN: KCALLAGHAN		2016/07/21	APPR: TMCLELL		2016/08/24																																																																																											
INITIAL REVISION:		<table border="1" style="width: 100%; border-collapse: collapse;"> <tr> <td style="width: 30%;">DOCUMENT NUMBER</td> <td style="width: 10%;">DOC TYPE</td> <td style="width: 10%;">DOC PART</td> <td style="width: 10%;">REVISION</td> </tr> <tr> <td style="text-align: center; font-size: 1.2em;">SD-75783-001</td> <td style="text-align: center;">PSD</td> <td style="text-align: center;">001</td> <td style="text-align: center;">F</td> </tr> </table>								DOCUMENT NUMBER	DOC TYPE						DOC PART	REVISION	SD-75783-001	PSD	001	F																																																																																																			
DOCUMENT NUMBER	DOC TYPE									DOC PART	REVISION																																																																																																														
SD-75783-001	PSD						001	F																																																																																																																	
DRWN: KCALLAGHAN		2016/07/21																																																																																																																							
APPR: TMCLELL		2016/08/24																																																																																																																							
ANGULAR TOL ± 0.5°			<table style="width: 100%; border: none;"> <tr> <td colspan="2">MATERIAL NUMBER</td> <td colspan="3">CUSTOMER</td> <td colspan="2">SHEET NUMBER</td> </tr> <tr> <td colspan="2">SEE TABLE</td> <td colspan="3">GENERAL MARKET</td> <td colspan="2">3 OF 13</td> </tr> </table>							MATERIAL NUMBER		CUSTOMER			SHEET NUMBER		SEE TABLE		GENERAL MARKET			3 OF 13																																																																																																			
MATERIAL NUMBER		CUSTOMER								SHEET NUMBER																																																																																																															
SEE TABLE		GENERAL MARKET								3 OF 13																																																																																																															
4 PLACES ±																																																																																																																									
3 PLACES ±																																																																																																																									
2 PLACES ± 0.13																																																																																																																									
1 PLACE ± 0.25																																																																																																																									
0 PLACES ±																																																																																																																									
DRAFT WHERE APPLICABLE MUST REMAIN WITHIN DIMENSIONS			THIRD ANGLE PROJECTION		DRAWING		SERIES		C-SIZE																																																																																																																
							75783																																																																																																																		

MATING INTERFACE (FOR REFERENCE ONLY)

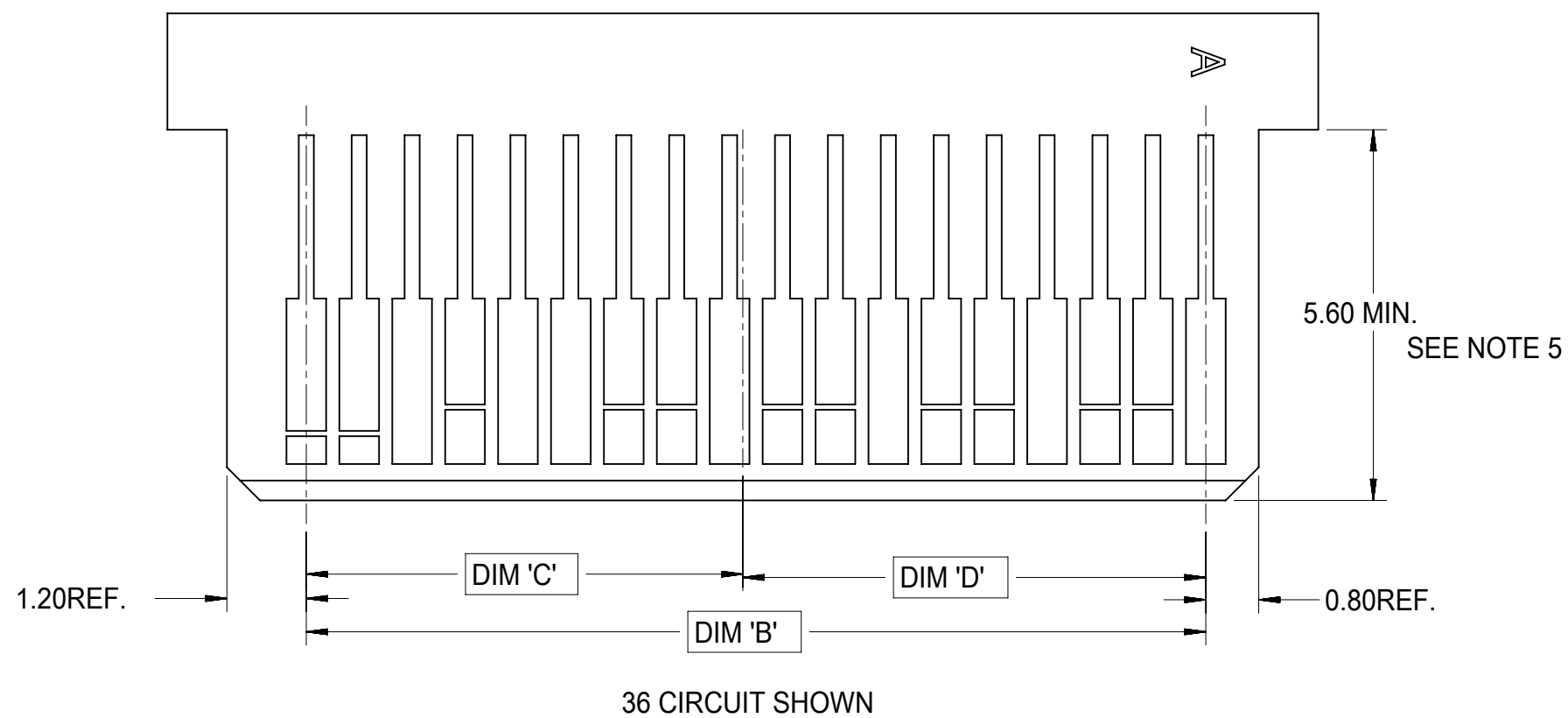
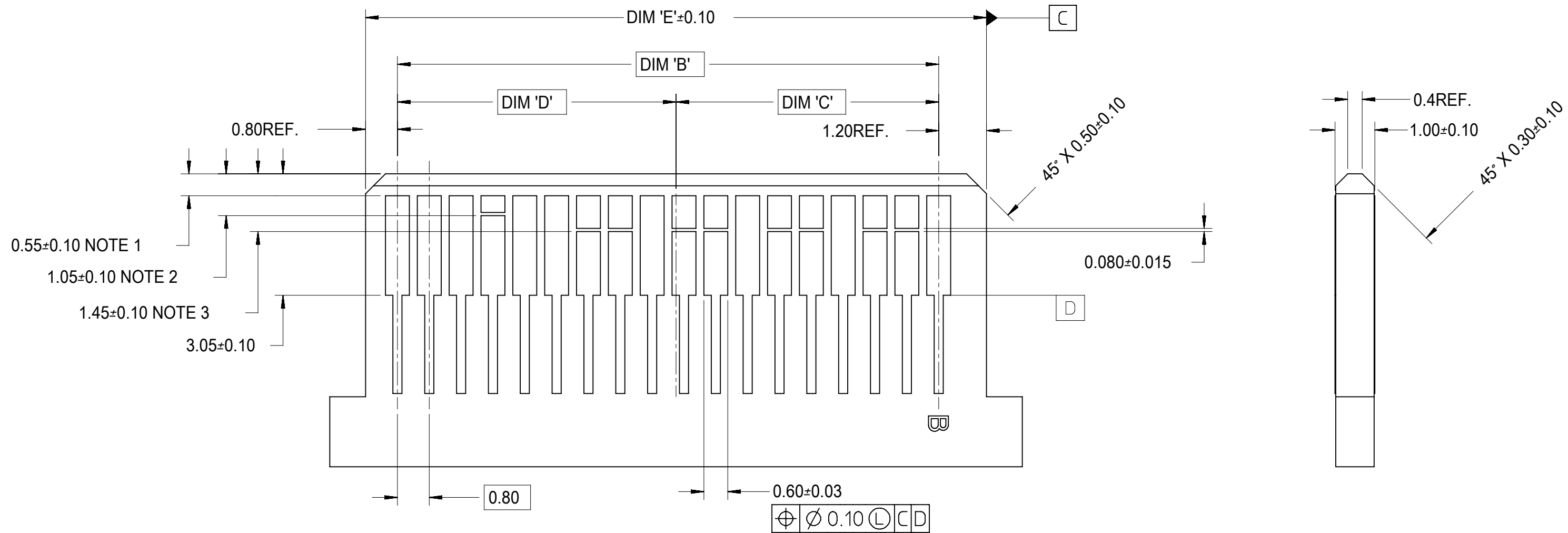

- NOTES:
- PAD CONFIGURATION FOR FIRST MATE.
 - PAD CONFIGURATION FOR SECOND MATE.
 - PAD CONFIGURATION FOR THIRD MATE. (HIGH SPEED SIGNALS)
 - FOR PIN ASSIGNMENTS AND MATING SEQUENCE (1ST, 2ND, 3RD), SEE APPLICABLE SPECIFICATION.
 - MINIMUM STEP REQUIRED IF PCB MADE WIDER THAN TONGUE.

CIRCUIT SIZE	TERM/SIDE 'N'	DIM 'B'	DIM 'C'	DIM 'D'	DIM 'E'
26	13	9.60	4.60	5.00	11.60
36	18	13.60	6.60	7.00	15.60
50	25	19.20	9.40	9.80	21.20
68	34	26.40	13.00	13.40	28.40

SYMBOLS		THIS DRAWING CONTAINS INFORMATION THAT IS PROPRIETARY TO MOLEX ELECTRONIC TECHNOLOGIES, LLC AND SHOULD NOT BE USED WITHOUT WRITTEN PERMISSION	
	= 0	DIMENSION UNITS	SCALE
	= 0	mm	1:1
	= 0	CURRENT REV DESC:	
	= 0	GENERAL TOLERANCES (UNLESS SPECIFIED)	
	= 0	ANGULAR TOL ± 0.5°	
	= 0	EC NO: 173961	
	= 0	DRWN: RWHIPPLE 2018/03/19	
	= 0	CHK'D: SMILLER 2018/03/21	
	= 0	APPR: SMILLER 2018/03/21	
	= 0	INITIAL REVISION:	
	= 0	DRWN: KCALLAGHAN 2016/07/21	
	= 0	APPR: TMCLELL 2016/08/24	
	= 0	DRAFT WHERE APPLICABLE MUST REMAIN WITHIN DIMENSIONS	
	= 0	THIRD ANGLE PROJECTION	DRAWING SERIES
	= 0		C-SIZE 75783
		MATERIAL NUMBER CUSTOMER SHEET NUMBER	
		SEE TABLE GENERAL MARKET 4 OF 13	

molex

I-PASS R/A CONNECTOR
INTERNAL ASSY W/SHELL 0.8MM PITCH I/O

PRODUCT CUSTOMER DRAWING

DOCUMENT NUMBER DOC TYPE DOC PART REVISION

SD-75783-001 PSD 001 F

MATERIAL NUMBER CUSTOMER SHEET NUMBER

SEE TABLE GENERAL MARKET 4 OF 13

ASSEMBLY WITH PRE-POSITION DEVICE

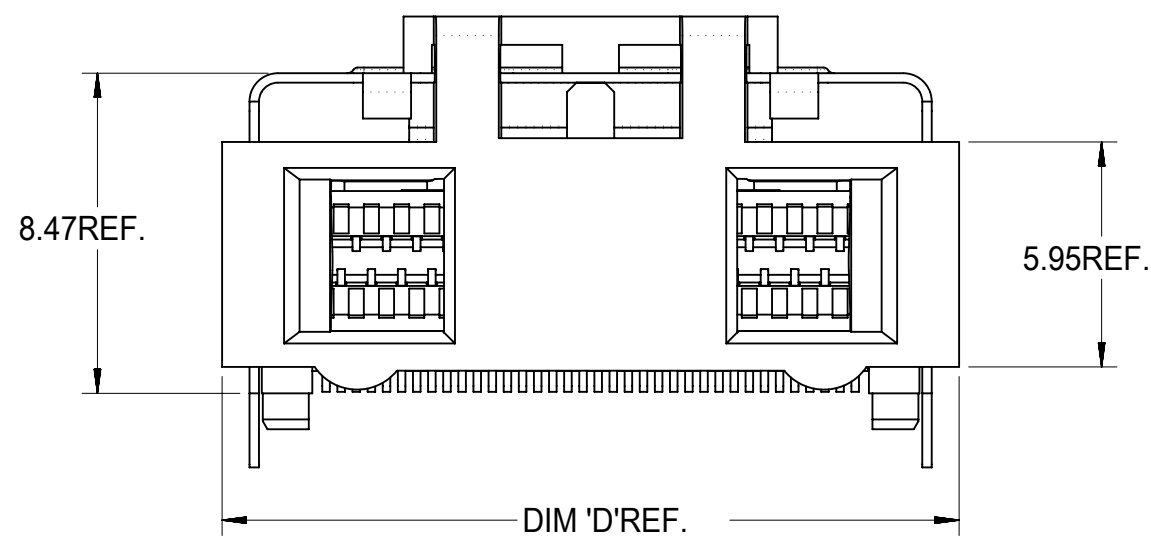
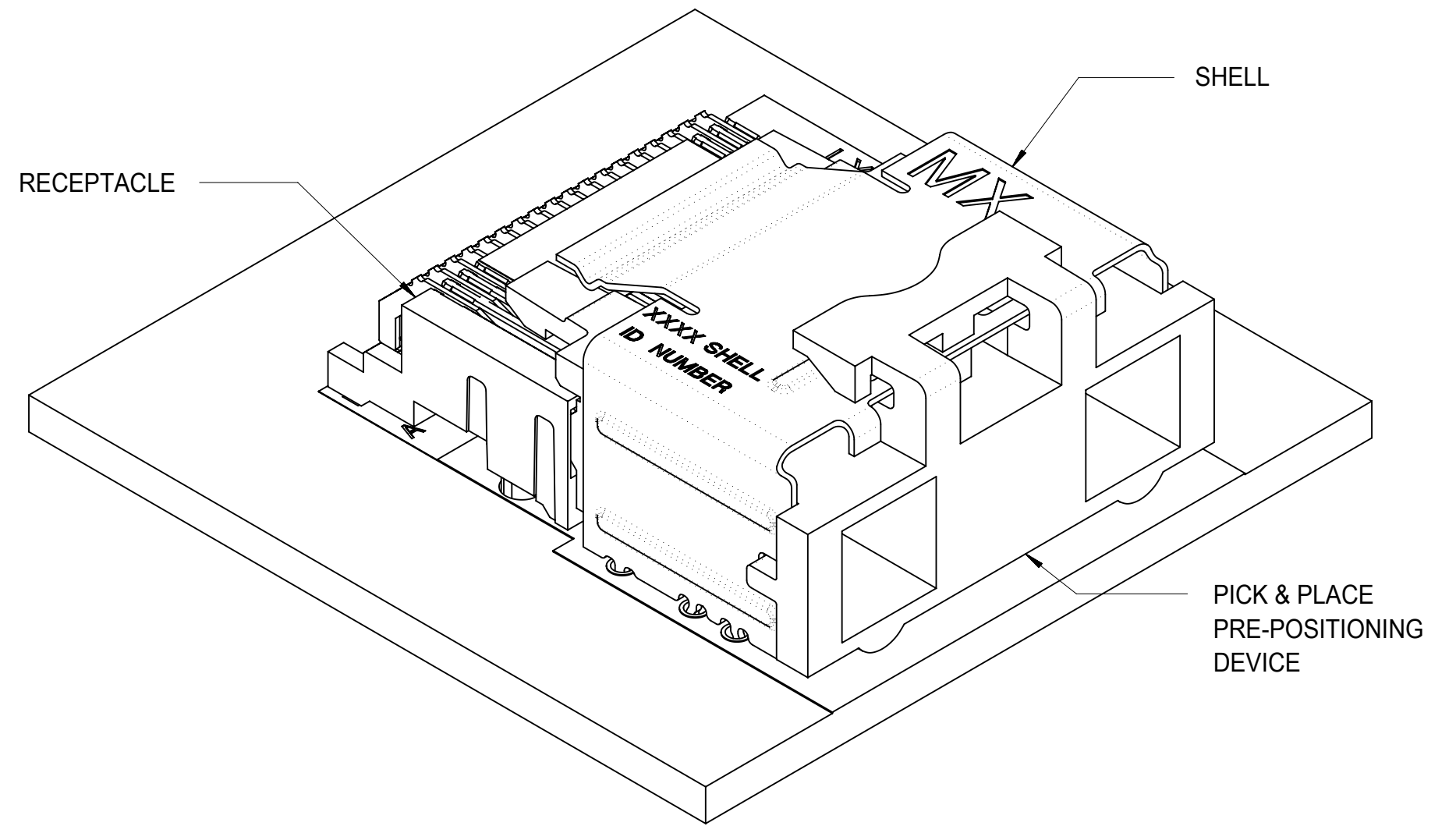
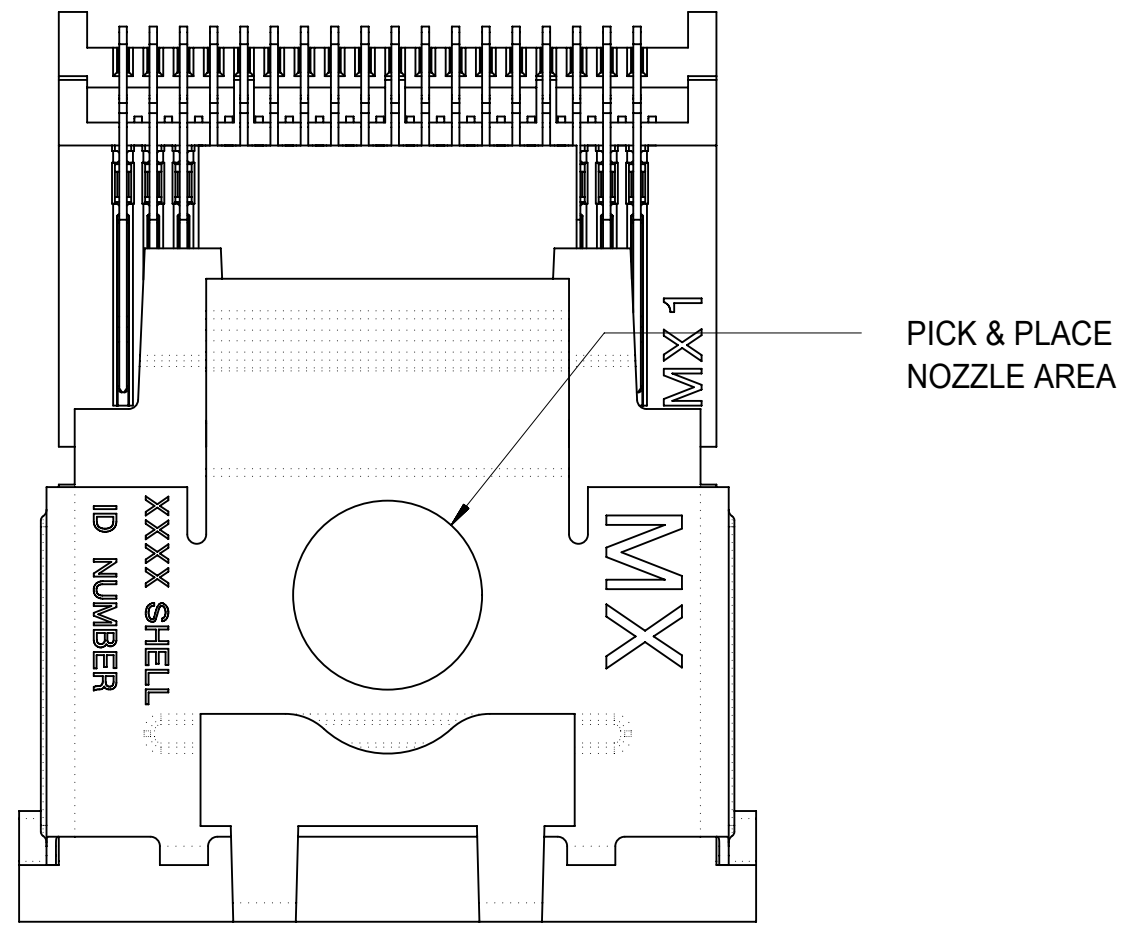

36 CIRCUIT RETENTION-FIT SHELL OPTION SHOWN

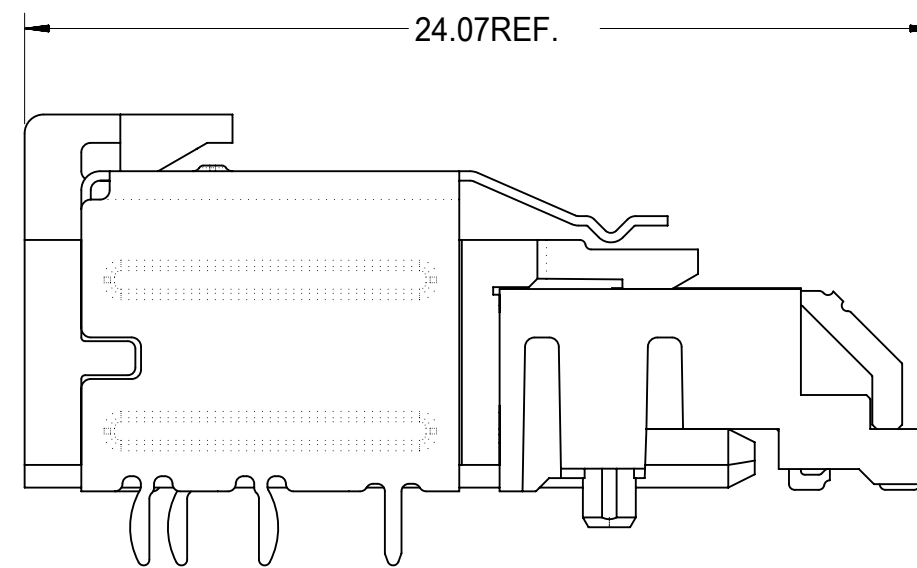

NOTES:

1. PICK AND PLACE AREA DEFINED IN APPLICATION SPECIFICATION, AS-75783-001
2. PACKAGING CONSISTS OF CONNECTOR AND SHELL WITH A PRE-POSITIONING PICK AND PLACE DEVICE THAT ARE PACKAGED IN "TAPE AND REEL" FOR ROBOTIC PICK AND PLACE.

CIRCUIT SIZE	DIM 'D'
26	15.50
36	19.50
50	25.10
68	32.30

SYMBOLS		THIS DRAWING CONTAINS INFORMATION THAT IS PROPRIETARY TO MOLEX ELECTRONIC TECHNOLOGIES, LLC AND SHOULD NOT BE USED WITHOUT WRITTEN PERMISSION	
DIMENSION UNITS	SCALE	CURRENT REV DESC:	
$\nabla = 0$	mm	1:1	
$\nabla = 0$	GENERAL TOLERANCES (UNLESS SPECIFIED)		
$\nabla = 0$	ANGULAR TOL $\pm 0.5^\circ$		
$\nabla = 0$	4 PLACES	\pm	
$\nabla = 0$	3 PLACES	\pm	
$\nabla = 0$	2 PLACES	± 0.13	
$\nabla = 0$	1 PLACE	± 0.25	
$\nabla = 0$	0 PLACES	\pm	
$\nabla = 0$	DRAFT WHERE APPLICABLE MUST REMAIN WITHIN DIMENSIONS		
	THIRD ANGLE PROJECTION	DRAWING	SERIES
		C-SIZE	75783
	EC NO: 173961		
	DRWN: RWHIPPLE	2018/03/19	
	CHK'D: SMILLER	2018/03/21	
	APPR: SMILLER	2018/03/21	
	INITIAL REVISION:		
	DRWN: KCALLAGHAN	2016/07/21	
	APPR: TMCLELL	2016/08/24	
	DOCUMENT NUMBER		DOC TYPE DOC PART REVISION
	SD-75783-001		PSD 001 F
	MATERIAL NUMBER	CUSTOMER	SHEET NUMBER
	SEE TABLE	GENERAL MARKET	5 OF 13

molex

I-PASS R/A CONNECTOR
INTERNAL ASSY W/SHELL 0.8MM PITCH I/O

PRODUCT CUSTOMER DRAWING

KEYING OPTIONS

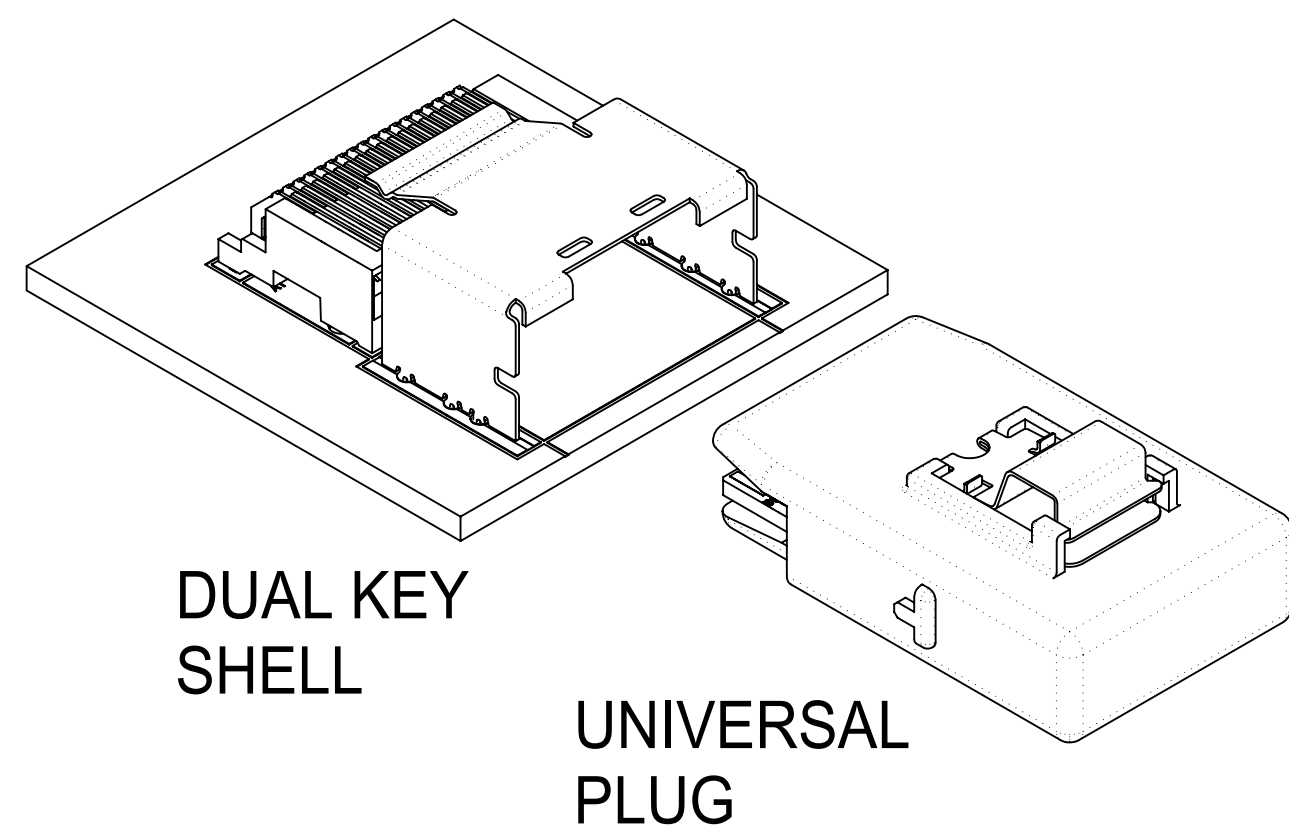
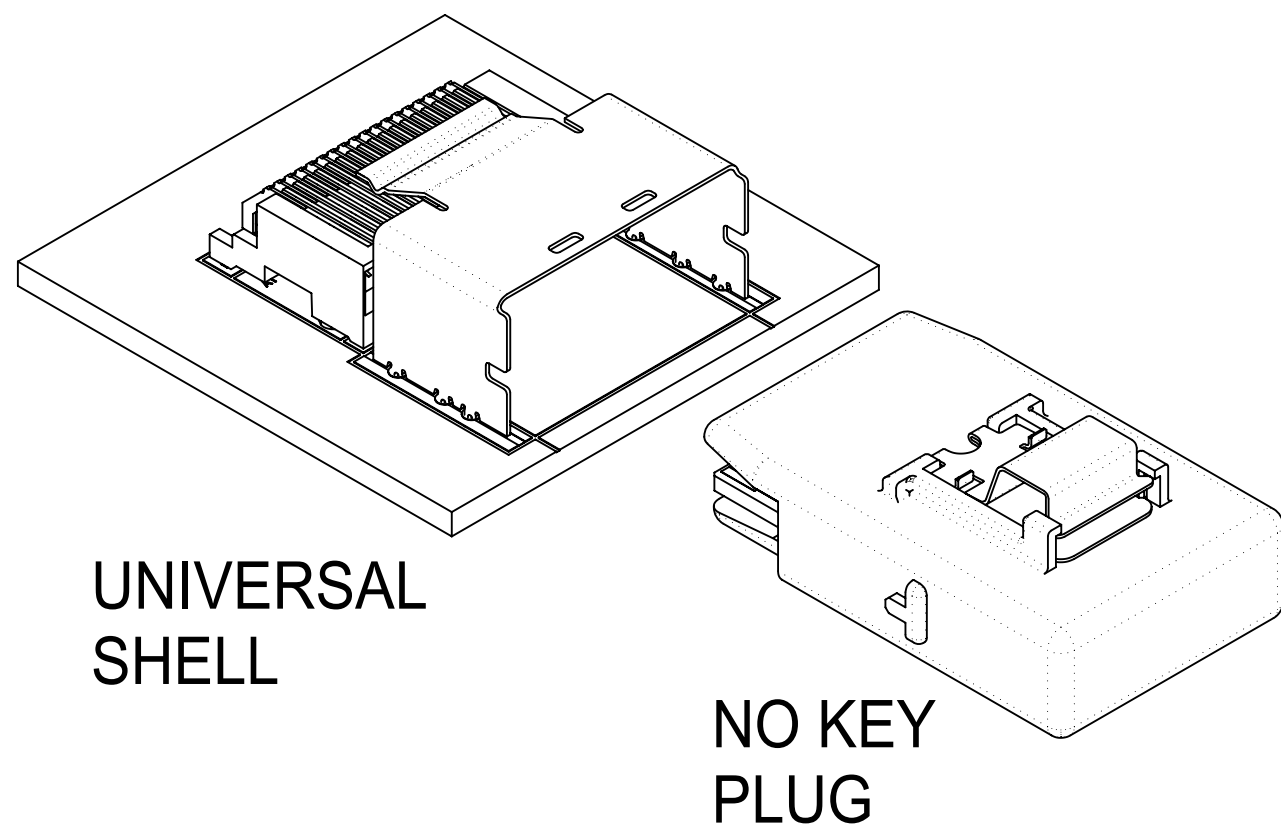
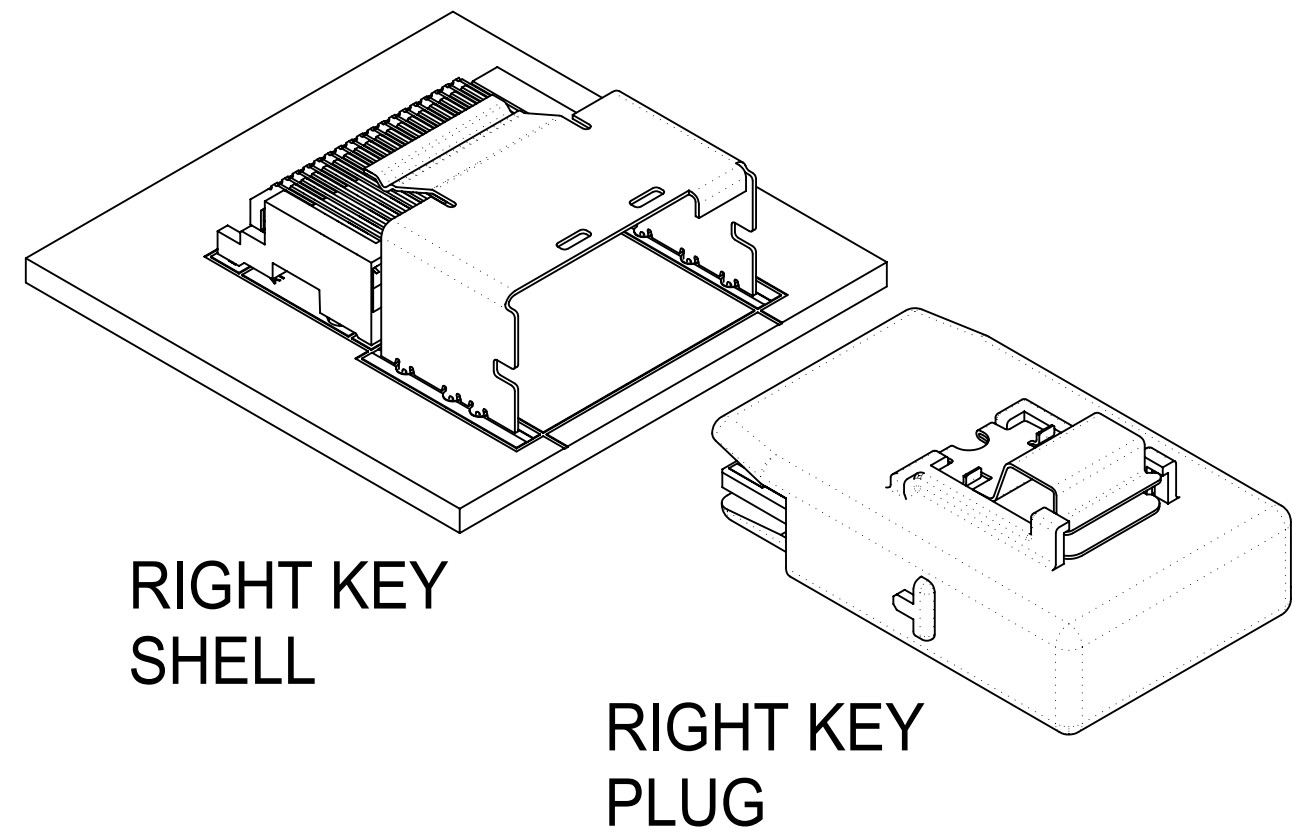
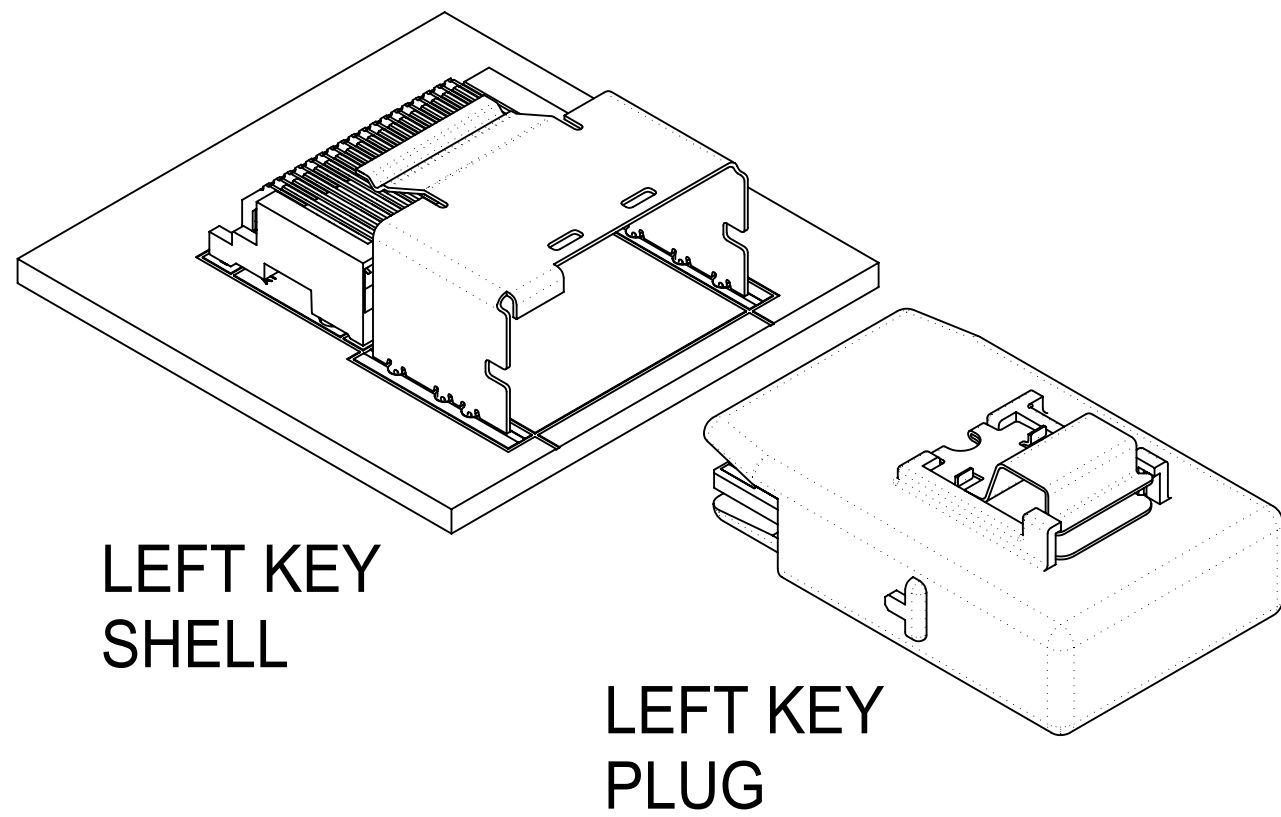

	UNIVERSAL SHELL	LEFT KEY SHELL	RIGHT KEY SHELL	DUAL KEY SHELL
NO KEY PLUG	YES	NO	NO	NO
LEFT KEY PLUG	YES	YES	NO	NO
RIGHT KEY PLUG	YES	NO	YES	NO
UNIVERSAL PLUG	YES	YES	YES	YES

THIS DRAWING CONTAINS INFORMATION THAT IS PROPRIETARY TO MOLEX ELECTRONIC TECHNOLOGIES, LLC AND SHOULD NOT BE USED WITHOUT WRITTEN PERMISSION												
SYMBOLS		DIMENSION UNITS		SCALE		CURRENT REV DESC:						
▽ = 0	▽ = 0	mm	1:1	GENERAL TOLERANCES (UNLESS SPECIFIED)		molex I-PASS R/A CONNECTOR INTERNAL ASSY W/SHELL 0.8MM PITCH I/O PRODUCT CUSTOMER DRAWING						
▽ = 0	▽ = 0	ANGULAR TOL ± 0.5°		4 PLACES ±						EC NO: 173961	2018/03/19	
▽ = 0	▽ = 0	2 PLACES ± 0.13		3 PLACES ±						DRWN: RWHIPPLE	2018/03/21	
▽ = 0	▽ = 0	1 PLACE ± 0.25		0 PLACES ±						CHK'D: SMILLER	2018/03/21	
☒ = 0	■ = 0	DRAFT WHERE APPLICABLE MUST REMAIN WITHIN DIMENSIONS		THIRD ANGLE PROJECTION		INITIAL REVISION:		DOCUMENT NUMBER				
▽ = 0				DRAWING		DRWN: KCALLAGHAN		SD-75783-001				
				SERIES		APPR: TMCLELL		DOC TYPE DOC PART REVISION				
				C-SIZE		2016/07/21		PSD 001 F				
				75783		2016/08/24		SHEET NUMBER				
						SEE TABLE		7 OF 13				
						GENERAL MARKET						

26 CIRCUIT ITEM NUMBERS

CIRCUIT SIZE	ITEM NUMBER	PLATING OPTION	SHELL PCB OPTION	SHELL KEY OPTION
26	75783-0007	OPTION 1	RETENTION	LEFT
26	75783-0008	OPTION 1	RETENTION	RIGHT
26	75783-0009	OPTION 1	RETENTION	DUAL
26	75783-0010	OPTION 1	SMT	LEFT
26	75783-0011	OPTION 1	SMT	RIGHT
26	75783-0012	OPTION 1	SMT	DUAL
26	75783-0019	OPTION 2	RETENTION	LEFT
26	75783-0020	OPTION 2	RETENTION	RIGHT
26	75783-0021	OPTION 2	RETENTION	DUAL
26	75783-0022	OPTION 2	SMT	LEFT
26	75783-0023	OPTION 2	SMT	RIGHT
26	75783-0024	OPTION 2	SMT	DUAL
26	75783-0025	OPTION 1	RETENTION	UNIVERSAL
26	75783-0026	OPTION 1	SMT	UNIVERSAL
26	75783-0027	OPTION 2	RETENTION	UNIVERSAL
26	75783-0028	OPTION 2	SMT	UNIVERSAL
26	75783-0029	OPTION 1	T/H 1.96	LEFT
26	75783-0030	OPTION 1	T/H 1.96	RIGHT
26	75783-0031	OPTION 1	T/H 1.96	DUAL
26	75783-0032	OPTION 1	T/H 1.96	UNIVERSAL
26	75783-0033	OPTION 2	T/H 1.96	LEFT
26	75783-0034	OPTION 2	T/H 1.96	RIGHT
26	75783-0035	OPTION 2	T/H 1.96	DUAL
26	75783-0036	OPTION 2	T/H 1.96	UNIVERSAL



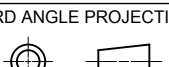





CIRCUIT SIZE	ITEM NUMBER	PLATING OPTION	SHELL PCB OPTION	SHELL KEY OPTION
26	75783-0037	OPTION 1	T/H 2.79	LEFT
26	75783-0038	OPTION 1	T/H 2.79	RIGHT
26	75783-0039	OPTION 1	T/H 2.79	DUAL
26	75783-0040	OPTION 1	T/H 2.79	UNIVERSAL
26	75783-0041	OPTION 2	T/H 2.79	LEFT
26	75783-0042	OPTION 2	T/H 2.79	RIGHT
26	75783-0043	OPTION 2	T/H 2.79	DUAL
26	75783-0044	OPTION 2	T/H 2.79	UNIVERSAL
26	75783-0045	OPTION 1	T/H 3.18	LEFT
26	75783-0046	OPTION 1	T/H 3.18	RIGHT
26	75783-0047	OPTION 1	T/H 3.18	DUAL
26	75783-0048	OPTION 1	T/H 3.18	UNIVERSAL
26	75783-0049	OPTION 2	T/H 3.18	LEFT
26	75783-0050	OPTION 2	T/H 3.18	RIGHT
26	75783-0051	OPTION 2	T/H 3.18	DUAL
26	75783-0052	OPTION 2	T/H 3.18	UNIVERSAL

THIS DRAWING CONTAINS INFORMATION THAT IS PROPRIETARY TO MOLEX ELECTRONIC TECHNOLOGIES, LLC AND SHOULD NOT BE USED WITHOUT WRITTEN PERMISSION											
SYMBOLS	DIMENSION UNITS	SCALE	CURRENT REV DESC:								
	mm	1:1									
▽ = 0	GENERAL TOLERANCES (UNLESS SPECIFIED)		EC NO: 173961				I-PASS R/A CONNECTOR INTERNAL ASSY W/SHELL 0.8MM PITCH I/O				
	ANGULAR TOL ± 0.5°		DRWN: RWHIPPLE 2018/03/19								
▽ = 0	4 PLACES ±		CHK'D: SMILLER 2018/03/21				PRODUCT CUSTOMER DRAWING				
▽ = 0	3 PLACES ±		APPR: SMILLER 2018/03/21								
▽ = 0	2 PLACES ± 0.13		INITIAL REVISION:				DOCUMENT NUMBER SD-75783-001				
▽ = 0	1 PLACE ± 0.25		DRWN: KCALLAGHAN 2016/07/21								
▽ = 0	0 PLACES ±		APPR: TMCLELL 2016/08/24				DOC TYPE DOC PART REVISION PSD 001 F				
▽ = 0	DRAFT WHERE APPLICABLE MUST REMAIN WITHIN DIMENSIONS		THIRD ANGLE PROJECTION		DRAWING					SERIES	
▽ = 0					C-SIZE		75783		MATERIAL NUMBER SEE TABLE	CUSTOMER GENERAL MARKET	SHEET NUMBER 8 OF 13

36 CIRCUIT ITEM NUMBERS

CIRCUIT SIZE	ITEM NUMBER	PLATING OPTION	SHELL PCB OPTION	SHELL KEY OPTION
36	75783-0107	OPTION 1	RETENTION	LEFT
36	75783-0108	OPTION 1	RETENTION	RIGHT
36	75783-0109	OPTION 1	RETENTION	DUAL
36	75783-0110	OPTION 1	SMT	LEFT
36	75783-0111	OPTION 1	SMT	RIGHT
36	75783-0112	OPTION 1	SMT	DUAL
36	75783-0119	OPTION 2	RETENTION	LEFT
36	75783-0120	OPTION 2	RETENTION	RIGHT
36	75783-0121	OPTION 2	RETENTION	DUAL
36	75783-0122	OPTION 2	SMT	LEFT
36	75783-0123	OPTION 2	SMT	RIGHT
36	75783-0124	OPTION 2	SMT	DUAL
36	75783-0125	OPTION 1	RETENTION	UNIVERSAL
36	75783-0126	OPTION 1	SMT	UNIVERSAL
36	75783-0127	OPTION 2	RETENTION	UNIVERSAL
36	75783-0128	OPTION 2	SMT	UNIVERSAL
36	75783-0129	OPTION 1	T/H 1.96	LEFT
36	75783-0130	OPTION 1	T/H 1.96	RIGHT
36	75783-0131	OPTION 1	T/H 1.96	DUAL
36	75783-0132	OPTION 1	T/H 1.96	UNIVERSAL
36	75783-0133	OPTION 2	T/H 1.96	LEFT
36	75783-0134	OPTION 2	T/H 1.96	RIGHT
36	75783-0135	OPTION 2	T/H 1.96	DUAL
36	75783-0136	OPTION 2	T/H 1.96	UNIVERSAL
36	75783-0170	OPTION 1	T/H 1.40	UNIVERSAL

CIRCUIT SIZE	ITEM NUMBER	PLATING OPTION	SHELL PCB OPTION	SHELL KEY OPTION
36	75783-0137	OPTION 1	T/H 2.79	LEFT
36	75783-0138	OPTION 1	T/H 2.79	RIGHT
36	75783-0139	OPTION 1	T/H 2.79	DUAL
36	75783-0140	OPTION 1	T/H 2.79	UNIVERSAL
36	75783-0141	OPTION 2	T/H 2.79	LEFT
36	75783-0142	OPTION 2	T/H 2.79	RIGHT
36	75783-0143	OPTION 2	T/H 2.79	DUAL
36	75783-0144	OPTION 2	T/H 2.79	UNIVERSAL
36	75783-0145	OPTION 1	T/H 3.18	LEFT
36	75783-0146	OPTION 1	T/H 3.18	RIGHT
36	75783-0147	OPTION 1	T/H 3.18	DUAL
36	75783-0148	OPTION 1	T/H 3.18	UNIVERSAL
36	75783-0149	OPTION 2	T/H 3.18	LEFT
36	75783-0150	OPTION 2	T/H 3.18	RIGHT
36	75783-0151	OPTION 2	T/H 3.18	DUAL
36	75783-0152	OPTION 2	T/H 3.18	UNIVERSAL
36	75783-0153	OPTION 1	T/H 3.56	LEFT
36	75783-0154	OPTION 1	T/H 3.56	RIGHT
36	75783-0155	OPTION 1	T/H 3.56	DUAL
36	75783-0156	OPTION 1	T/H 3.56	UNIVERSAL
36	75783-0157	OPTION 2	T/H 3.56	LEFT
36	75783-0158	OPTION 2	T/H 3.56	RIGHT
36	75783-0159	OPTION 2	T/H 3.56	DUAL
36	75783-0160	OPTION 2	T/H 3.56	UNIVERSAL

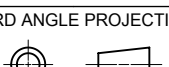
SYMBOLS  = 0  = 0  = 0  = 0  = 0  = 0  = 0  = 0  = 0	THIS DRAWING CONTAINS INFORMATION THAT IS PROPRIETARY TO MOLEX ELECTRONIC TECHNOLOGIES, LLC AND SHOULD NOT BE USED WITHOUT WRITTEN PERMISSION						
	DIMENSION UNITS	SCALE	CURRENT REV DESC:				
	mm	1:1					
	GENERAL TOLERANCES (UNLESS SPECIFIED)		EC NO: 173961				
	ANGULAR TOL ± 0.5°		DRWN: RWHIPPLE	2018/03/19			
	4 PLACES ±		CHK'D: SMILLER	2018/03/21			
	3 PLACES ±		APPR: SMILLER	2018/03/21			
	2 PLACES ± 0.13		INITIAL REVISION:				
	1 PLACE ± 0.25		DRWN: KCALLAGHAN	2016/07/21			
	0 PLACES ±		APPR: TMCLELL	2016/08/24			
DRAFT WHERE APPLICABLE MUST REMAIN WITHIN DIMENSIONS		THIRD ANGLE PROJECTION	DRAWING	SERIES	MATERIAL NUMBER	CUSTOMER	SHEET NUMBER
			C-SIZE	75783	SEE TABLE	GENERAL MARKET	9 OF 13

molex

I-PASS R/A CONNECTOR
INTERNAL ASSY W/SHELL 0.8MM PITCH I/O

PRODUCT CUSTOMER DRAWING

DOCUMENT NUMBER	DOC TYPE	DOC PART	REVISION
SD-75783-001	PSD	001	F

50 CIRCUIT ITEM NUMBERS

CIRCUIT SIZE	ITEM NUMBER	PLATING OPTION	SHELL PCB OPTION	SHELL KEY OPTION
50	75783-0207	OPTION 1	RETENTION	LEFT
50	75783-0208	OPTION 1	RETENTION	RIGHT
50	75783-0209	OPTION 1	RETENTION	DUAL
50	75783-0210	OPTION 1	SMT	LEFT
50	75783-0211	OPTION 1	SMT	RIGHT
50	75783-0212	OPTION 1	SMT	DUAL
50	75783-0219	OPTION 2	RETENTION	LEFT
50	75783-0220	OPTION 2	RETENTION	RIGHT
50	75783-0221	OPTION 2	RETENTION	DUAL
50	75783-0222	OPTION 2	SMT	LEFT
50	75783-0223	OPTION 2	SMT	RIGHT
50	75783-0224	OPTION 2	SMT	DUAL
50	75783-0225	OPTION 1	RETENTION	UNIVERSAL
50	75783-0226	OPTION 1	SMT	UNIVERSAL
50	75783-0227	OPTION 2	RETENTION	UNIVERSAL
50	75783-0228	OPTION 2	SMT	UNIVERSAL
50	75783-0229	OPTION 1	T/H 1.96	LEFT
50	75783-0230	OPTION 1	T/H 1.96	RIGHT
50	75783-0231	OPTION 1	T/H 1.96	DUAL
50	75783-0232	OPTION 1	T/H 1.96	UNIVERSAL
50	75783-0233	OPTION 2	T/H 1.96	LEFT
50	75783-0234	OPTION 2	T/H 1.96	RIGHT
50	75783-0235	OPTION 2	T/H 1.96	DUAL
50	75783-0236	OPTION 2	T/H 1.96	UNIVERSAL

CIRCUIT SIZE	ITEM NUMBER	PLATING OPTION	SHELL PCB OPTION	SHELL KEY OPTION
50	75783-0237	OPTION 1	T/H 2.79	LEFT
50	75783-0238	OPTION 1	T/H 2.79	RIGHT
50	75783-0239	OPTION 1	T/H 2.79	DUAL
50	75783-0240	OPTION 1	T/H 2.79	UNIVERSAL
50	75783-0241	OPTION 2	T/H 2.79	LEFT
50	75783-0242	OPTION 2	T/H 2.79	RIGHT
50	75783-0243	OPTION 2	T/H 2.79	DUAL
50	75783-0244	OPTION 2	T/H 2.79	UNIVERSAL
50	75783-0245	OPTION 1	T/H 3.18	LEFT
50	75783-0246	OPTION 1	T/H 3.18	RIGHT
50	75783-0247	OPTION 1	T/H 3.18	DUAL
50	75783-0248	OPTION 1	T/H 3.18	UNIVERSAL
50	75783-0249	OPTION 2	T/H 3.18	LEFT
50	75783-0250	OPTION 2	T/H 3.18	RIGHT
50	75783-0251	OPTION 2	T/H 3.18	DUAL
50	75783-0252	OPTION 2	T/H 3.18	UNIVERSAL

SYMBOLS = 0 = 0 = 0 = 0 = 0 = 0 = 0 = 0 = 0	THIS DRAWING CONTAINS INFORMATION THAT IS PROPRIETARY TO MOLEX ELECTRONIC TECHNOLOGIES, LLC AND SHOULD NOT BE USED WITHOUT WRITTEN PERMISSION						
	DIMENSION UNITS	SCALE	CURRENT REV DESC:				
	mm	1:1					
	GENERAL TOLERANCES (UNLESS SPECIFIED)		EC NO: 173961				
	ANGULAR TOL ± 0.5°		DRWN: RWHIPPLE	2018/03/19			
	4 PLACES ±		CHK'D: SMILLER	2018/03/21			
	3 PLACES ±		APPR: SMILLER	2018/03/21			
	2 PLACES ± 0.13		INITIAL REVISION:				
	1 PLACE ± 0.25		DRWN: KCALLAGHAN	2016/07/21			
	0 PLACES ±		APPR: TMCLELL	2016/08/24			
DRAFT WHERE APPLICABLE MUST REMAIN WITHIN DIMENSIONS		THIRD ANGLE PROJECTION	DRAWING	SERIES	MATERIAL NUMBER	CUSTOMER	SHEET NUMBER
			C-SIZE	75783	SEE TABLE	GENERAL MARKET	10 OF 13



I-PASS R/A CONNECTOR
INTERNAL ASSY W/SHELL 0.8MM PITCH I/O

PRODUCT CUSTOMER DRAWING

DOCUMENT NUMBER	DOC TYPE	DOC PART	REVISION
SD-75783-001	PSD	001	F

68 CIRCUIT ITEM NUMBERS

CIRCUIT SIZE	ITEM NUMBER	PLATING OPTION	SHELL PCB OPTION	SHELL KEY OPTION
68	75783-0307	OPTION 1	RETENTION	LEFT
68	75783-0308	OPTION 1	RETENTION	RIGHT
68	75783-0309	OPTION 1	RETENTION	DUAL
68	75783-0310	OPTION 1	SMT	LEFT
68	75783-0311	OPTION 1	SMT	RIGHT
68	75783-0312	OPTION 1	SMT	DUAL
68	75783-0319	OPTION 2	RETENTION	LEFT
68	75783-0320	OPTION 2	RETENTION	RIGHT
68	75783-0321	OPTION 2	RETENTION	DUAL
68	75783-0322	OPTION 2	SMT	LEFT
68	75783-0323	OPTION 2	SMT	RIGHT
68	75783-0324	OPTION 2	SMT	DUAL
68	75783-0325	OPTION 1	RETENTION	UNIVERSAL
68	75783-0326	OPTION 1	SMT	UNIVERSAL
68	75783-0327	OPTION 2	RETENTION	UNIVERSAL
68	75783-0328	OPTION 2	SMT	UNIVERSAL
68	75783-0329	OPTION 1	T/H 1.96	LEFT
68	75783-0330	OPTION 1	T/H 1.96	RIGHT
68	75783-0331	OPTION 1	T/H 1.96	DUAL
68	75783-0332	OPTION 1	T/H 1.96	UNIVERSAL
68	75783-0333	OPTION 2	T/H 1.96	LEFT
68	75783-0334	OPTION 2	T/H 1.96	RIGHT
68	75783-0335	OPTION 2	T/H 1.96	DUAL
68	75783-0336	OPTION 2	T/H 1.96	UNIVERSAL

CIRCUIT SIZE	ITEM NUMBER	PLATING OPTION	SHELL PCB OPTION	SHELL KEY OPTION
68	75783-0337	OPTION 1	T/H 2.79	LEFT
68	75783-0338	OPTION 1	T/H 2.79	RIGHT
68	75783-0339	OPTION 1	T/H 2.79	DUAL
68	75783-0340	OPTION 1	T/H 2.79	UNIVERSAL
68	75783-0341	OPTION 2	T/H 2.79	LEFT
68	75783-0342	OPTION 2	T/H 2.79	RIGHT
68	75783-0343	OPTION 2	T/H 2.79	DUAL
68	75783-0344	OPTION 2	T/H 2.79	UNIVERSAL
68	75783-0345	OPTION 1	T/H 3.18	LEFT
68	75783-0346	OPTION 1	T/H 3.18	RIGHT
68	75783-0347	OPTION 1	T/H 3.18	DUAL
68	75783-0348	OPTION 1	T/H 3.18	UNIVERSAL
68	75783-0349	OPTION 2	T/H 3.18	LEFT
68	75783-0350	OPTION 2	T/H 3.18	RIGHT
68	75783-0351	OPTION 2	T/H 3.18	DUAL
68	75783-0352	OPTION 2	T/H 3.18	UNIVERSAL

SYMBOLS = 0 = 0 = 0 = 0 = 0 = 0 = 0 = 0 = 0	THIS DRAWING CONTAINS INFORMATION THAT IS PROPRIETARY TO MOLEX ELECTRONIC TECHNOLOGIES, LLC AND SHOULD NOT BE USED WITHOUT WRITTEN PERMISSION			
	DIMENSION UNITS	SCALE	CURRENT REV DESC:	
	mm	1:1		
	GENERAL TOLERANCES (UNLESS SPECIFIED)		EC NO: 173961	
	ANGULAR TOL	± 0.5°	DRWN: RWHIPPLE	2018/03/19
	4 PLACES	±	CHK'D: SMILLER	2018/03/21
	3 PLACES	±	APPR: SMILLER	2018/03/21
	2 PLACES	± 0.13	INITIAL REVISION:	
	1 PLACE	± 0.25	DRWN: KCALLAGHAN	2016/07/21
	0 PLACES	±	APPR: TMCLELL	2016/08/24
DRAFT WHERE APPLICABLE MUST REMAIN WITHIN DIMENSIONS		THIRD ANGLE PROJECTION	DRAWING	SERIES
			C-SIZE	75783

I-PASS R/A CONNECTOR
INTERNAL ASSY W/SHELL 0.8MM PITCH I/O

PRODUCT CUSTOMER DRAWING

DOCUMENT NUMBER	DOC TYPE	DOC PART	REVISION
SD-75783-001	PSD	001	F

MATERIAL NUMBER	CUSTOMER	SHEET NUMBER
SEE TABLE	GENERAL MARKET	11 OF 13

RIGHT ANGLE CONNECTOR WITH RETENTION FIT & THRU-HOLE SHELL PCB FOOT PRINT

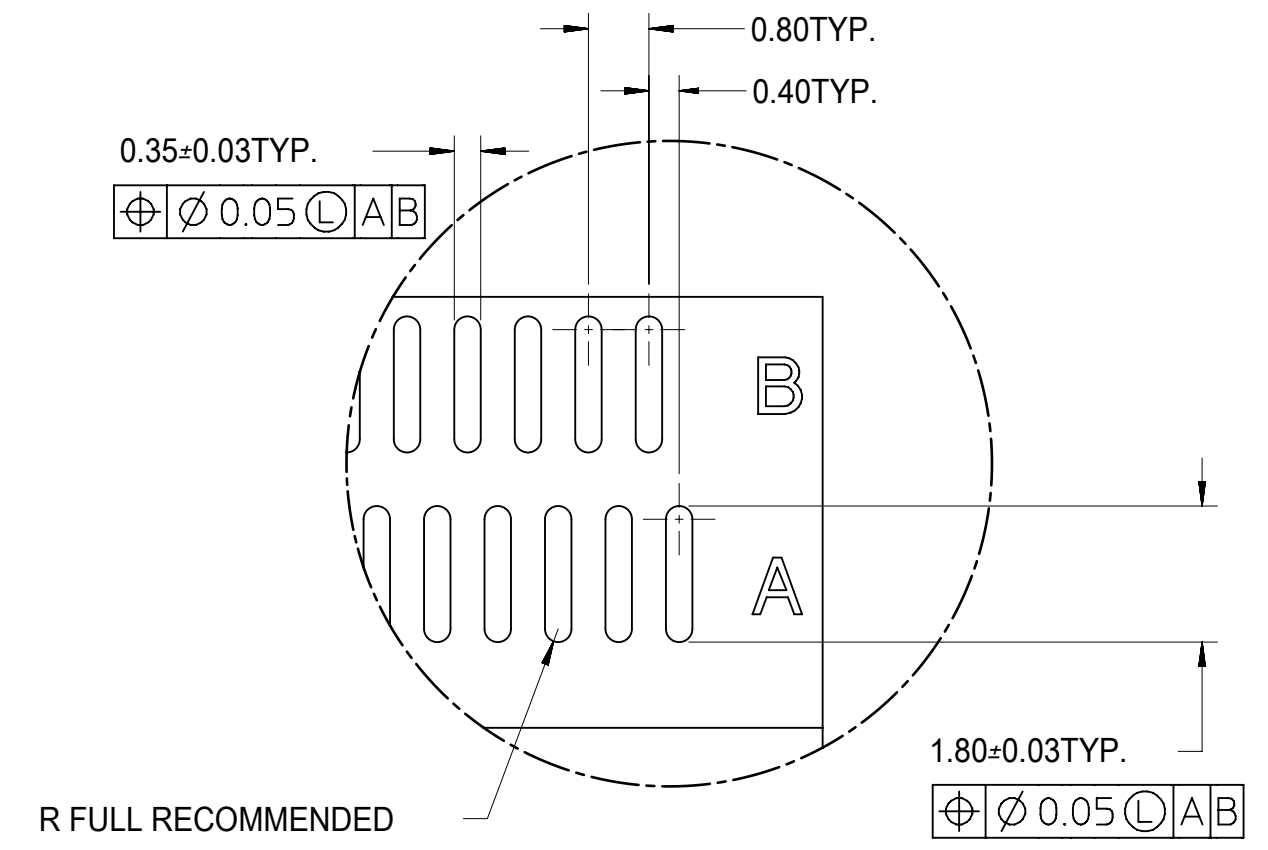
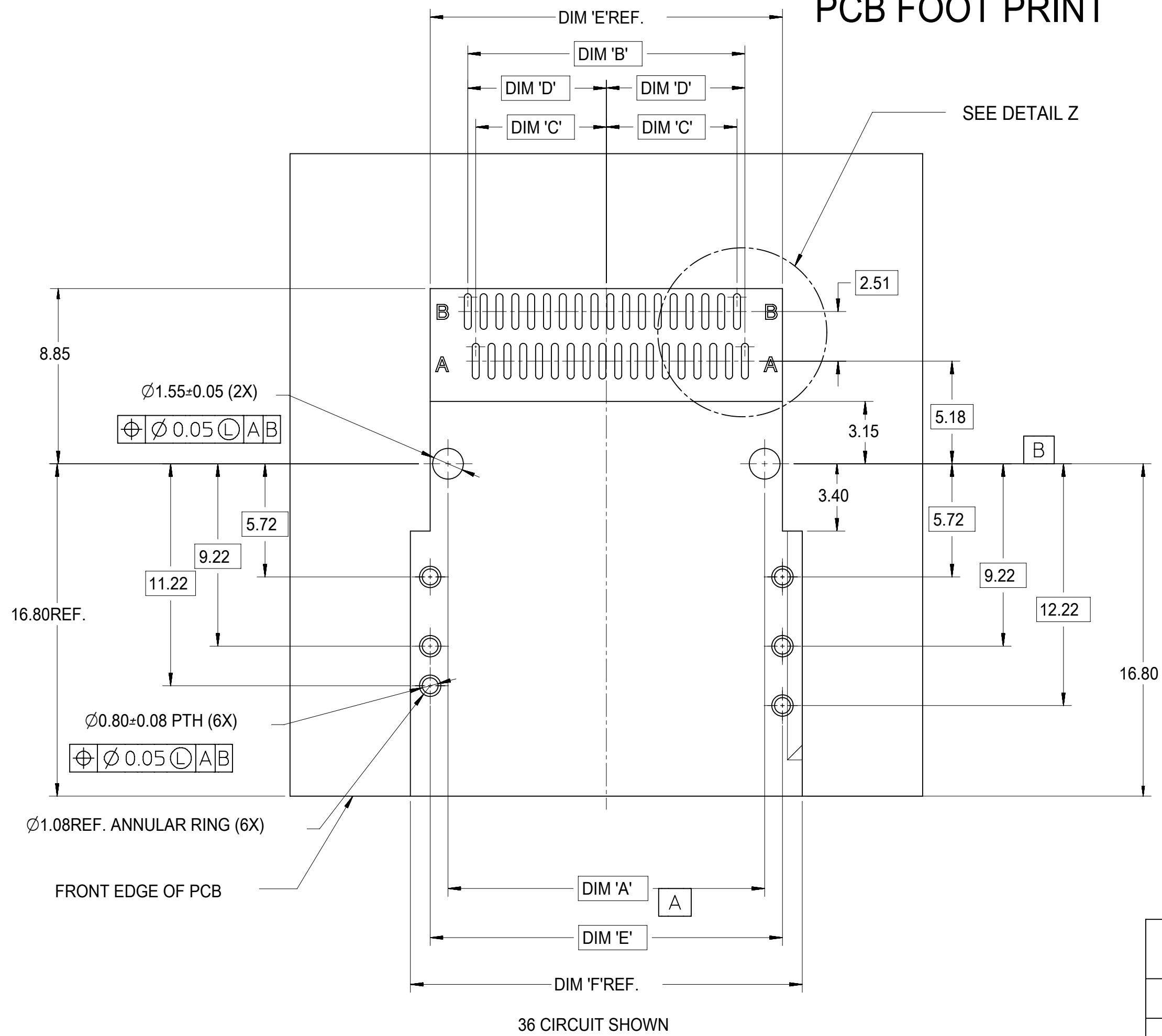









DETAIL Z
SCALE 10:1

CIRCUIT SIZE	DIMENSIONS					
	PEG TO PEG	FIRST PAD TO LAST PAD	CENTERLINE TO PAD	CENTERLINE TO PAD	CONNECTOR WIDTH SHELL PEG TO PEG	SHELL FOOTPRINT WIDTH
26	DIM 'A'	DIM 'B'	DIM 'C'	DIM 'D'	DIM 'E'	DIM 'F'
36	12.00	10.00	4.60	5.00	13.80	15.80
50	16.00	14.00	6.60	7.00	17.80	19.80
68	21.60	19.60	9.40	9.80	23.40	25.40
	28.80	26.80	13.00	13.40	30.60	32.60

THIS DRAWING CONTAINS INFORMATION THAT IS PROPRIETARY TO MOLEX ELECTRONIC TECHNOLOGIES, LLC AND SHOULD NOT BE USED WITHOUT WRITTEN PERMISSION																																			
SYMBOLS		DIMENSION UNITS		SCALE		CURRENT REV DESC:																													
▽ = 0		mm		1:1		<div style="text-align: right; font-weight: bold; font-size: 1.2em;">molex</div> <p style="text-align: center;">I-PASS R/A CONNECTOR INTERNAL ASSY W/SHELL 0.8MM PITCH I/O</p> <p style="text-align: center;">PRODUCT CUSTOMER DRAWING</p> <table border="1" style="width: 100%; border-collapse: collapse;"> <tr> <td colspan="3">DOCUMENT NUMBER</td> <td>DOC TYPE</td> <td>DOC PART</td> <td>REVISION</td> </tr> <tr> <td colspan="3" style="text-align: center; font-weight: bold;">SD-75783-001</td> <td>PSD</td> <td>001</td> <td>F</td> </tr> <tr> <td colspan="2">MATERIAL NUMBER</td> <td colspan="2">CUSTOMER</td> <td colspan="2">SHEET NUMBER</td> </tr> <tr> <td colspan="2">SEE TABLE</td> <td colspan="2">GENERAL MARKET</td> <td colspan="2">12 OF 13</td> </tr> </table>						DOCUMENT NUMBER			DOC TYPE	DOC PART	REVISION	SD-75783-001			PSD	001	F	MATERIAL NUMBER		CUSTOMER		SHEET NUMBER		SEE TABLE		GENERAL MARKET		12 OF 13	
DOCUMENT NUMBER			DOC TYPE	DOC PART	REVISION																														
SD-75783-001			PSD	001	F																														
MATERIAL NUMBER		CUSTOMER		SHEET NUMBER																															
SEE TABLE		GENERAL MARKET		12 OF 13																															
▽ = 0		GENERAL TOLERANCES (UNLESS SPECIFIED)				EC NO: 173961																													
▽ = 0		ANGULAR TOL ± 0.5°				DRWN: RWHIPPLE 2018/03/19																													
▽ = 0		4 PLACES ±				CHK'D: SMILLER 2018/03/21																													
▽ = 0		3 PLACES ±				APPR: SMILLER 2018/03/21																													
▽ = 0		2 PLACES ± 0.13				INITIAL REVISION:																													
▽ = 0		1 PLACE ± 0.25				DRWN: KCALLAGHAN 2016/07/21																													
▽ = 0		0 PLACES ±				APPR: TMCLELL 2016/08/24																													
▽ = 0		DRAFT WHERE APPLICABLE MUST REMAIN WITHIN DIMENSIONS		THIRD ANGLE PROJECTION		DRAWING		SERIES		MATERIAL NUMBER																									
▽ = 0						C-SIZE		75783		SEE TABLE																									

H
G
F
E
D
C
B
A

DATE	REV	DESCRIPTION
2018/03/20	F	1. REMASTERED FROM MODEL MANAGER
		2. SHEET 1, NOTE 3, COPLANAR DISTANCE CHANGED FROM 0.15 TO 0.10

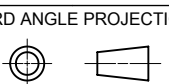
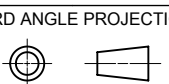
THIS DRAWING CONTAINS INFORMATION THAT IS PROPRIETARY TO MOLEX ELECTRONIC TECHNOLOGIES, LLC AND SHOULD NOT BE USED WITHOUT WRITTEN PERMISSION															
SYMBOLS  = 0  = 0  = 0  = 0  = 0  = 0  = 0  = 0  = 0	DIMENSION UNITS mm	SCALE 1:1	CURRENT REV DESC: EC NO: 173961 DRWN: RWHIPPLE 2018/03/19 CHK'D: SMILLER 2018/03/21 APPR: SMILLER 2018/03/21							 I-PASS R/A CONNECTOR INTERNAL ASSY W/SHELL 0.8MM PITCH I/O					
	GENERAL TOLERANCES (UNLESS SPECIFIED)		INITIAL REVISION: DRWN: KCALLAGHAN 2016/07/21 APPR: TMCLELL 2016/08/24										PRODUCT CUSTOMER DRAWING		
	ANGULAR TOL ± 0.5°		DRAFT WHERE APPLICABLE MUST REMAIN WITHIN DIMENSIONS							DOCUMENT NUMBER SD-75783-001			DOC TYPE PSD	DOC PART 001	REVISION F
	4 PLACES ±		THIRD ANGLE PROJECTION 		DRAWING C-SIZE	SERIES 75783	MATERIAL NUMBER SEE TABLE		CUSTOMER GENERAL MARKET		SHEET NUMBER 13 OF 13				
	3 PLACES ±		2 PLACES ± 0.13		1 PLACE ± 0.25		0 PLACES ±								