

**User Manual**

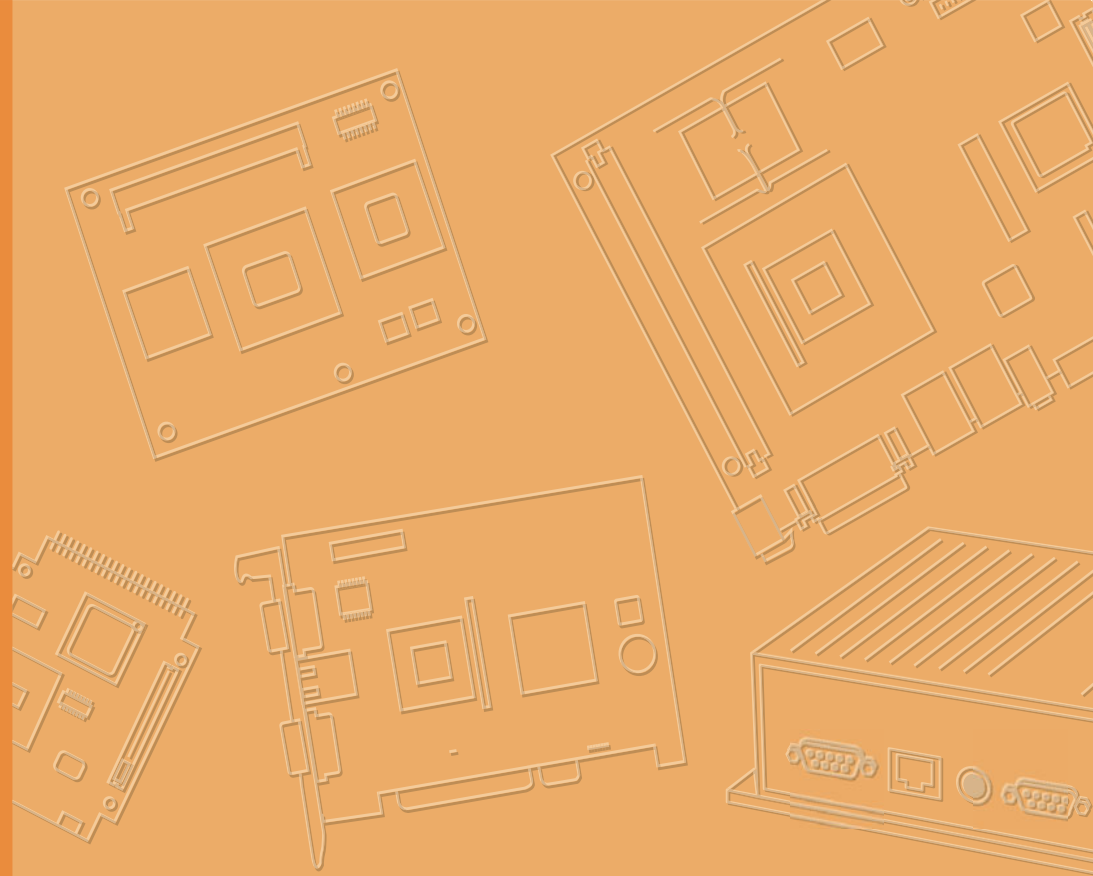

# **TREK-570/TREK-303**

**In-Vehicle Computing Box / 7"  
Smart Display**

---

## Copyright

The documentation and the software included with this product are copyrighted 2015 by Advantech Co., Ltd. All rights are reserved. Advantech Co., Ltd. reserves the right to make improvements in the products described in this manual at any time without notice. No part of this manual may be reproduced, copied, translated or transmitted in any form or by any means without the prior written permission of Advantech Co., Ltd. Information provided in this manual is intended to be accurate and reliable. However, Advantech Co., Ltd. assumes no responsibility for its use, nor for any infringements of the rights of third parties, which may result from its use.

## Acknowledgements

Intel and Atom are trademarks of Intel Corporation.

Microsoft Windows and MS-DOS is registered trademarks of Microsoft Corp.

All other product names or trademarks are properties of their respective owners.

## Product Warranty (2 years)

Advantech warrants to you, the original purchaser, that each of its products will be free from defects in materials and workmanship for two years from the date of purchase.

This warranty does not apply to any products which have been repaired or altered by persons other than repair personnel authorized by Advantech, or which have been subject to misuse, abuse, accident or improper installation. Advantech assumes no liability under the terms of this warranty as a consequence of such events.

Because of Advantech's high quality-control standards and rigorous testing, most of our customers never need to use our repair service. If an Advantech product is defective, it will be repaired or replaced at no charge during the warranty period. For out-of-warranty repairs, you will be billed according to the cost of replacement materials, service time and freight. Please consult your dealer for more details.

If you think you have a defective product, follow these steps:

1. Collect all the information about the problem encountered. (For example, CPU speed, Advantech products used, other hardware and software used, etc.) Note anything abnormal and list any onscreen messages you get when the problem occurs.
2. Call your dealer and describe the problem. Please have your manual, product, and any helpful information readily available.
3. If your product is diagnosed as defective, obtain an RMA (return merchandise authorization) number from your dealer. This allows us to process your return more quickly.
4. Carefully pack the defective product, a fully-completed Repair and Replacement Order Card and a photocopy proof of purchase date (such as your sales receipt) in a shippable container. A product returned without proof of the purchase date is not eligible for warranty service.
5. Write the RMA number visibly on the outside of the package and ship it prepaid to your dealer.

Part No.  
Printed in Taiwan

Edition 1  
January 2015

# Declaration of Conformity

## CE

This product has passed the CE test for environmental specifications. Test conditions for passing included the equipment being operated within an industrial enclosure. In order to protect the product from being damaged by ESD (Electrostatic Discharge) and EMI leakage, we strongly recommend the use of CE-compliant industrial enclosure products.

## FCC Class B

Note: This equipment has been tested and found to comply with the limits for a Class B digital device, pursuant to part 15 of the FCC Rules. These limits are designed to provide reasonable protection against harmful interference in a residential installation. This equipment generates, uses and can radiate radio frequency energy and, if not installed and used in accordance with the instructions, may cause harmful interference to radio communications. However, there is no guarantee that interference will not occur in a particular installation. If this equipment does cause harmful interference to radio or television reception, which can be determined by turning the equipment off and on, the user is encouraged to try to correct the interference by one or more of the following measures:

- Reorient or relocate the receiving antenna.
- Increase the separation between the equipment and receiver.
- Connect the equipment into an outlet on a circuit different from that to which the receiver is connected.
- Consult the dealer or an experienced radio/TV technician for help.

## Technical Support and Assistance

1. Visit the Advantech web site at <http://support.advantech.com> where you can find the latest information about the product.
2. Contact your distributor, sales representative, or Advantech's customer service center for technical support if you need additional assistance. Please have the following information ready before you call:
  - Product name and serial number
  - Description of your peripheral attachments
  - Description of your software (operating system, version, application software, etc.)
  - A complete description of the problem
  - The exact wording of any error messages

---

# Warnings, Cautions and Notes

**Warning!** Warnings indicate conditions, which if not observed, can cause personal injury!



**Caution!** Cautions are included to help you avoid damaging hardware or losing data. e.g.



*There is a danger of a new battery exploding if it is incorrectly installed. Do not attempt to recharge, force open, or heat the battery. Replace the battery only with the same or equivalent type recommended by the manufacturer. Discard used batteries according to the manufacturer's instructions.*

**Note!** Notes provide optional additional information.



## Document Feedback

To assist us in making improvements to this manual, we would welcome comments and constructive criticism. Please send all such - in writing to: [support@advantech.com](mailto:support@advantech.com)

## Packing List

Before setting up the system, check that the items listed below are included and in good condition. If any item does not accord with the table, please contact your dealer immediately.

- TREK-570 In-Vehicle Computing Box
- USB/HDMI cable clip
- Power cable
- Vehicle I/O cable (Dual CAN/J1708, RS-485) in/CAN cable
- Generic I/O Cable
- Antenna (base on order configuration request)

# Ordering Information

P/N	Description
TREK-570-00A0E	TREK-570 Intel BYT E3826(2C,1.46GHz)Barebone
TREK-570-LWB7A0E	TREK-570 w/LTE(EU)/GPS/WLAN/BT/WES7
TREK-570-LWB7B0E	TREK-570 w/LTE(USA)/GPS/WLAN/BT/WES7

## Safety Instructions

1. Read these safety instructions carefully.
2. Keep this User Manual for later reference.
3. Disconnect this equipment from any AC outlet before cleaning. Use a damp cloth. Do not use liquid or spray detergents for cleaning.
4. For plug-in equipment, the power outlet socket must be located near the equipment and must be easily accessible.
5. Keep this equipment away from humidity.
6. Put this equipment on a reliable surface during installation. Dropping it or letting it fall may cause damage.
7. Do not leave this equipment in an environment unconditioned where the storage temperature under  $-40^{\circ}\text{C}$  or above  $80^{\circ}\text{C}$ , it may damage the equipment. Operating temperature  $-30^{\circ}\text{C}$   $\sim 70^{\circ}\text{C}$
8. The openings on the enclosure are for air convection. Protect the equipment from overheating. **DO NOT COVER THE OPENINGS.**
9. Make sure the voltage of the power source is correct before connecting the equipment to the power outlet.
10. Position the power cord so that people cannot step on it. Do not place anything over the power cord. The voltage and current rating of the cord should be greater than the voltage and current rating marked on the product.
11. All cautions and warnings on the equipment should be noted.
12. If the equipment is not used for a long time, disconnect it from the power source to avoid damage by transient overvoltage.
13. Never pour any liquid into an opening. This may cause fire or electrical shock.
14. Never open the equipment. For safety reasons, the equipment should be opened only by qualified service personnel.
15. If one of the following situations arises, get the equipment checked by service personnel:
  - The power cord or plug is damaged.
  - Liquid has penetrated into the equipment.
  - The equipment has been exposed to moisture.
  - The equipment does not work well, or you cannot get it to work according to the user's manual.
  - The equipment has been dropped and damaged.
  - The equipment has obvious signs of breakage.
16. **CAUTION:** The computer is provided with a battery-powered real-time clock circuit. There is a danger of explosion if battery is incorrectly replaced. Replace only with same or equivalent type recommended by the manufacture. Discard

used batteries according to the manufacturers instructions.

17. THE COMPUTER IS PROVIDED WITH CD DRIVES COMPLY WITH APPROPRIATE SAFETY STANDARDS INCLUDING IEC 60825.

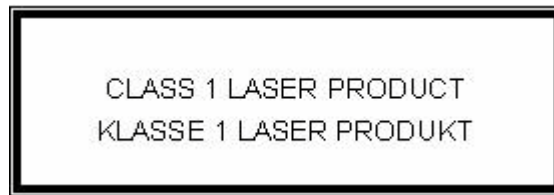

18. This device complies with Part 15 of the FCC rules. Operation is subject to the following two conditions:
  - (1) this device may not cause harmful interference, and
  - (2) this device must accept any interference received, including interference that may cause undesired operation.
19. CAUTION: Always completely disconnect the power cord from your chassis whenever you work with the hardware. Do not make connections while the power is on. Sensitive electronic components can be damaged by sudden power surges.
20. CAUTION: Always ground yourself to remove any static charge before touching the motherboard, backplane, or add-on cards. Modern electronic devices are very sensitive to static electric charges. As a safety precaution, use a grounding wrist strap at all times. Place all electronic components on a static-dissipative surface or in a static-shielded bag when they are not in the chassis.
21. CAUTION: Any unverified component could cause unexpected damage. To ensure the correct installation, please always use the components (ex. screws) provided with the accessory box.
22. Caution text concerning lithium batteries:



23. "Rack Mount Instructions - The following or similar rack-mount instructions are included with the installation instructions:
  - A) Elevated Operating Ambient - If installed in a closed or multi-unit rack assembly, the operating ambient temperature of the rack environment may be greater than room ambient. Therefore, consideration should be given to installing the equipment in an environment compatible with the maximum ambient temperature (T<sub>ma</sub>) specified by the manufacturer.
  - B) Reduced Air Flow - Installation of the equipment in a rack should be such that the amount of air flow required for safe operation of the equipment is not compromised.
  - C) Mechanical Loading - Mounting of the equipment in the rack should be such that a hazardous condition is not achieved due to uneven mechanical loading.
  - D) Circuit Overloading - Consideration should be given to the connection of the equipment to the supply circuit and the effect that overloading of the circuits might have on over current protection and supply wiring. Appropriate consideration of equipment nameplate ratings should be used when addressing this concern.

E) Reliable Earthing - Reliable earthing of rack-mounted equipment should be maintained. Particular attention should be given to supply connections other than direct connections to the branch circuit (e.g. use of power strips)."

## Safety Precaution - Static Electricity

Follow these simple precautions to protect yourself from harm and the products from damage.

- To avoid electrical shock, always disconnect the power from your system chassis before you work on it. Don't touch any components on the main board or other cards while the system is on.
- Disconnect power before making any configuration changes. The sudden rush of power as you connect a jumper or install a card may damage sensitive electronic components.

**Warning!**



1. *Input voltage rated: 6 ~ 32 Vdc.*
2. *Transport: carry the unit with both hands and handle with care.*
3. *Maintenance: to properly maintain and clean the surfaces, use only approved products or clean with a dry applicator.*
4. *Turn off the power before inserting or removing mSATA and Mini-PCIe card.*

**European Contact Information:**

Advantech Europe GmbH Kolberger Straße 7  
D-40599 Düsseldorf, Germany  
Tel: 49-211-97477350  
Fax: 49-211-97477300





# Contents

<b>Chapter 1</b>	<b>General Information .....</b>	<b>1</b>
1.1	Introduction .....	2
1.2	General Specifications .....	3
1.3	Dimensions .....	5
	Figure 1.1 TREK-570 dimensions.....	5
<b>Chapter 2</b>	<b>System Setup .....</b>	<b>7</b>
2.1	A Quick Tour of the TREK-570 Computing Box.....	8
	Figure 2.1 Front view of TREK-570 .....	8
	Figure 2.2 Rear view of TREK-570.....	8
2.2	Installation Procedures.....	8
2.2.1	Connecting the Power Cord.....	8
	Table 2.1: Pin Definition of Power Cord .....	8
2.2.2	Power Connector (12/24V; 9 ~ 32V).....	9
	Figure 2.3 Power connector outlook.....	9
	Table 2.2: Power Connector.....	9
2.3	Running the BIOS Setup Program .....	9
<b>Chapter 3</b>	<b>Hardware &amp; Peripheral Installation ..</b>	<b>11</b>
3.1	Overview of Hardware Installation & Upgrading .....	12
3.2	Installing the Storage Device and Memory .....	12
3.3	Installing Optional Accessories .....	12
3.3.1	Installing TREK-570 Peripheral Modules.....	12
	Figure 3.1 Install peripheral in the system .....	12
3.3.2	Installing the MiniPCIe Type WWAN, SIM Card and Coin Battery .	12
3.3.3	GPS Module.....	12
3.4	Paired with TREK-303 Specifications .....	13
<b>Chapter 4</b>	<b>Jumper Settings and Connectors ....</b>	<b>15</b>
4.1	Setting Jumpers and Switches.....	16
<b>Chapter 5</b>	<b>Pin Assignments .....</b>	<b>19</b>
5.1	Front Side Connectors .....	20
5.2	Rear Side Connectors.....	20
5.3	Power Connector (12/24V; 9 ~ 32V) .....	20
	Table 5.1: Power Connector.....	20
5.4	Smart Display Connector .....	21
	Table 5.2: Smart Display Connector.....	21
5.5	RS-232 Connector (COM3).....	22
	Table 5.3: RS232 Connector(COM3) .....	22
5.6	Vehicle I/O.....	22
	Table 5.4: Vehicle I/O .....	22
5.7	Generic I/O Connector .....	23
	Table 5.5: Generic I/O Connector.....	23

<b>Chapter 6</b>	<b>Software Demo Utility Setup.....</b>	<b>25</b>
6.1	Introduction .....	26
6.2	Execute VCIL Sample Code .....	26
6.2.1	System Menu.....	26
6.2.2	Testing VCIL.....	31
6.2.3	Testing CAN .....	34
6.2.4	Testing J1939 .....	37
6.2.5	Testing ODB2 .....	39
6.2.6	Testing J1708 .....	42
6.2.7	Testing J1587 .....	44
6.3	Vehicle Power Management .....	46
6.3.1	Power Management Mechanism .....	46
6.3.2	Power Management demo program .....	47
6.4	WatchDog Sample Code .....	51
6.5	Peripheral Control Demo Program.....	52
<b>Appendix A</b>	<b>TREK-303 .....</b>	<b>55</b>
A.1	Paired with TREK-303 Specifications .....	56
	Table A.1: TREK-303 Specification .....	56
	Figure A.1 Hotkey utility .....	59

# Chapter 1

## General Information

This chapter gives background information on the TREK-570 In-Vehicle Computing Box.

Sections include:

- Introduction
- General Specifications
- Dimensions

# 1.1 Introduction

TREK-570 is a compact and economical vehicle-grade, Intel Atom E3826 SOC empowered computing box mainly designed for fleet management market. It can work in extreme environments with features like the wide working temperature range (-30-70°C) and anti-shock/vibration to pass MIL-STD-810G and 5M3 standard. Its special power protection surges from impacting the system. guarding against damage from transient card power.

TREK-570 combined with variety of I/O connectors can be connected to devices like TPMS (Tire Pressure Monitoring System), Rear view Camera (for parking monitoring) and CAN Bus devices. It has dual CAN BUS ports and support several kind of vehicle protocols (e.g. J1939,OBD-II/ISO 15765) for vehicle diagnostics and driver behavior management. Build-in wireless communication (WWAN, WLAN,BT) enable TREK-570 to send import ant driver/vehicle/location/cargo information back to the control center. Furthermore, TREK-570 also reserved dual display/dual audio interfaces supporting different resolutions can deliver different applications to different displays; eg: one application to a fleet driver and another to passenger to IVI and digital signage application.

## I/O Connectors

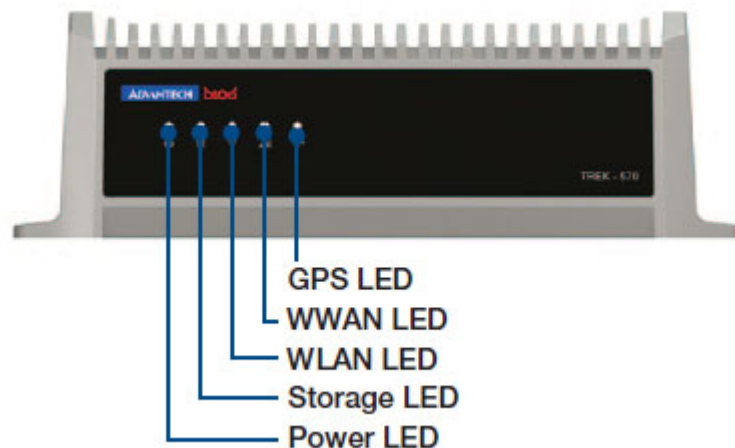
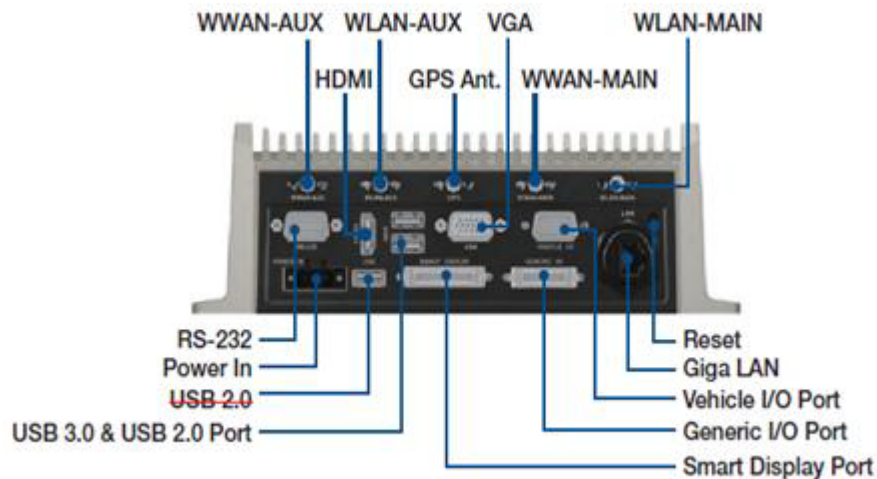

## 1.2 General Specifications

### Key features

- Automotive grade working temperature range (-30° C to 70° C)
- Rich I/O including CAN, LAN, RS-232, RS-485, J1708, isolation 4DI/4DO, Line out, Mic in, USB, and Video-in
- Built-in GSM/GPRS/LTE (support dual SIM Cards)/GNSS/BT and WLAN
- Certifications: CE/FCC/e-mark, MIL-SD810F, ISO 7637-2, SAE J1455, SAE J1113 regulations
- Dual independent display/audio output for both driver and passenger
- Ignition on/off delay; SW controllable for car power management

### Specifications

- **Dimensions: (W x H x D):** 229.6 x 71 x 117.9 mm
- **Weight:** 2 kg
- **Vehicle power feature:**
  - Input voltage: 6 ~ 32 Vdc, support ignition cold crank
  - Supports Ignition on/off
  - Supports low battery shut-down protection threshold (optional)
  - Supports power off event delay
  - Supports power on delay
  - Supports power low delay
  - Supports power low hard delay
  - Supports hard off delay

**Note!** For more detail of function please refer to Chapter 6, Section 6.3 of this manual.



- **CPU:** Intel Atom E3826(Dual Core, 1.46GHz)
- **Chipset:** Integrated in LE82US15EE
- **BIOS:** 4MB Flash BIOS, ACPI Compliant.
- **System memory:** One SODIMM sockets, accepts up to 4GB DDR3L1066 SDRAM
- **Storage:** One mSATA slot, support system boot up
- **Serial ports:** Two CAN Bus  
Two 4-wire RS232, 1 x RS485, 1 x J1708 ports
- **Universal serial bus (USB) port:** one USB3.0 Type A, one USB 2.0 Type A
- **LAN port:** 1 x 10/100/1000 Ethernet by RJ45

**Note!** This product is covered by one or more of the following patents:  
US5,307,459, US5,434,872, US5,732,094, US6,570,884, US6,115,776  
and US6,327,625.



- **Storage:** 1x Mini PCI express bus expansion slot for m-SATA: SATA rev2.0 bus
- **Video output:**
  - 1 X LVDS output by Smart Display port
  - 1 x VGA output by DB-15
  - 1 x HDMI output by HDMI 19pin Receptacle

\*note: 2 of 3 video output can be displayed simultaneously in BIOS or OS.
- **Video in:** 1 x composite video input (for rear view monitor) by BNC connector on Generic IO cable
- **Mini PCI express bus expansion slot:** Accepts full size mini PCIe bus card.
- **Mini PCI express bus expansion slot for WWAN:** support dual SIM card switch
- **Watchdog timer:** Supports 0-255 sec. time intervals, SW programmable and SW enable/disabled.
- **RTC Battery:** 3.0 V @ 200 mAH lithium battery.
- **Power management:** Supports power saving modes including Normal/ suspend-to-disk modes.
- **Digital I/O:** Isolated 4 digital input and 4 digital output
- **CAN/J1939 bus:** Support CAN V2.0B up to 1 Mb/s, by DB-9 connector on Vehicle I/O cable
- **ODBII bus:** up to 500kbps, by DB-9 connector on Vehicle I/O cable J1708 bus: 9600 bps, by DB-9 connector on Vehicle I/O cable
- **GNSS (Ublox MAX-M8Q/W):** GPS, GLONASS, BEIDOU
- **Audio:** 2 audio codecs, one is for smart display, one is for TREK-570 line out and mic in phone jack by Generic I/O cable.
- **RS-485:** up to 115200 bps by Generic I/O cable.
- **Optional modules:**
  - RF:
    - WLAN+BT (Sparklan WEPA-251N(BT)): IEEE802.11a/b/g/n MIMO +Bluetooth V4.0
    - WWAN (Sierra Wireless MC7304/54): Quad-band GSM/GPRS, HSDPA+, CDMA2000, LTE
    - PCI Express Bus Ethernet Interface: Ethernet: support 1000/100/10Base-T auto-sensing capability.
- **Operating temperature:** -30 ~ 70° C
- **Relative humidity:** 10 ~ 95% @ 40° C (non-condensing)
- **Shock:** 30 G peak acceleration (11 msec duration)
- **Certifications:** CE, FCC, CCC, Emark
- **Vibration:** 5 ~ 500 Hz SAE J1455 4.9.4.2, MIL-STD-810F 514.5

### 1.3 Dimensions

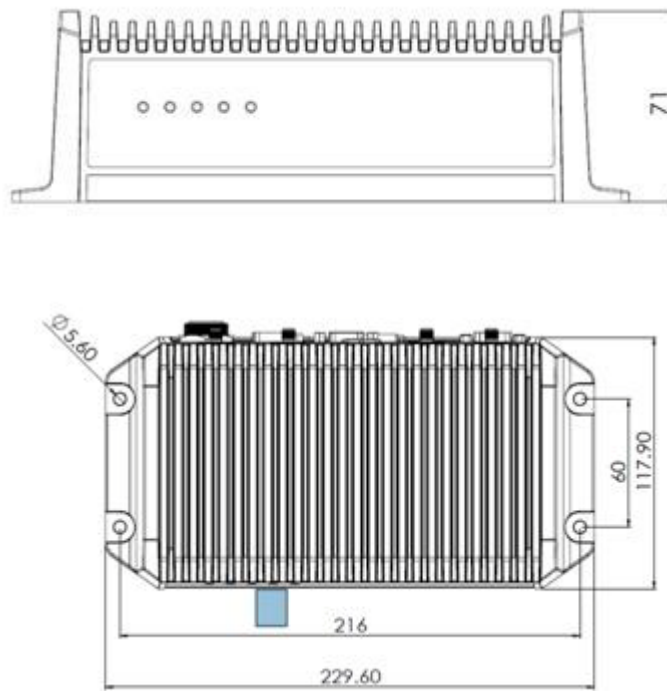

Figure 1.1 TREK-570 dimensions





# Chapter 2

## System Setup

This chapter details system setup on TREK-570.

Sections include:

- A Quick Tour of the Computer Box
- Installation Procedures
- Running the BIOS Setup Program

## 2.1 A Quick Tour of the TREK-570 Computing Box

Before starting to set up the In-Vehicle Computing Box, take a moment to become familiar with the locations and functions of the controls, drives, connectors and ports, which are illustrated in the figures below. When the Computer box is placed inside truck glove cabinet or under the passenger's seat next to the driver, its front appears as shown in Figure 2.1.

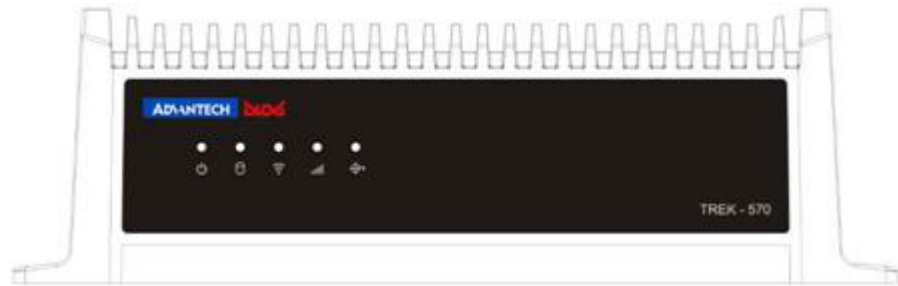

Figure 2.1 Front view of TREK-570

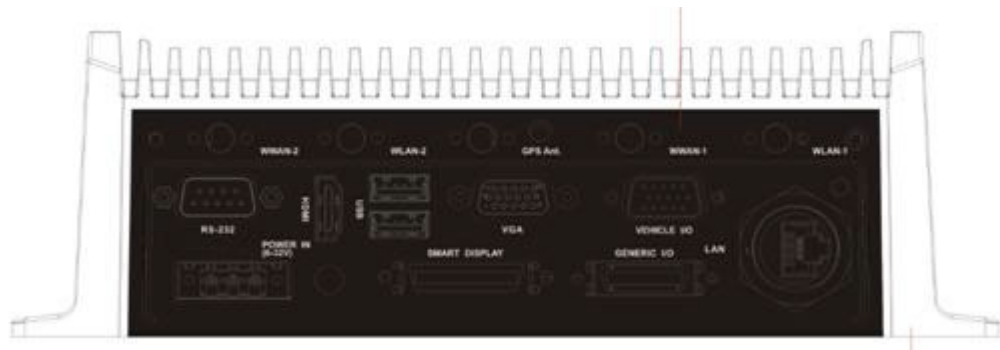

Figure 2.2 Rear view of TREK-570

## 2.2 Installation Procedures

### 2.2.1 Connecting the Power Cord

Connect the three pin waterproof power cord to the DC inlet of the In-Vehicle Computing Box. On the open-wire end, one pin is reserved for positive voltage and is marked, "+"; one pin is reserved for ground and is marked, "-"; and, one pin is reserved for the ignition signal with an "ignition" mark.

**Note!** *Ignition on/off setting: The TREK-570 supports an ignition on/off function so that you can power on/off the TREK-570 via the ignition signal/voltage and connect the TREK- vehicle ignition switch.*



Table 2.1: Pin Definition of Power Cord

Pin	Definition	Color
1	+	Red
2	-	Black
3	Ignition	Orange

## 2.2.2 Power Connector (12/24V; 9 ~ 32V)

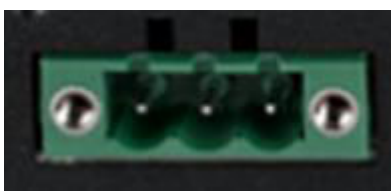

Figure 2.3 Power connector outlook

Table 2.2: Power Connector

Pin	Signal Depiction
1	Ground
2	Power Input (6 ~ 36 VDC; 18 ~ 58 VDC)
3	Acc Ignition Input

## 2.3 Running the BIOS Setup Program

In most cases, the computer will have been properly set up and configured by the dealer or SI prior to delivery. However, it may still be necessary to adjust some of the computer's BIOS (Basic Input-Output System) setup programs to change the system configuration data, like the current date and time, or the specific type of hard drive currently installed.

The setup program is stored in read-only memory (ROM). It can be accessed either when turning on or resetting the computer, by pressing the "Del" key on the keyboard immediately after powering up the computer.

The settings that are specified with the setup program are recorded in a special area of the memory called CMOS RAM. This memory is backed up by a battery so that it will not be erased when turning off or resetting the system. Whenever the power is turned on, the system reads the settings stored in CMOS RAM and compares them to the equipment check conducted during the power on self-test (POST). If an error occurs, an error message is displayed on screen, and the user is prompted to run the setup program.



# Chapter 3

## Hardware & Peripheral Installation

This chapter details the installation of hardware for TREK-570.

Sections include:

- Overview of Hardware Installation and Upgrading
- Installing the Storage Device and Memory
- Installing Optional Accessories
- Fuse

## 3.1 Overview of Hardware Installation & Upgrading

The In-Vehicle Computing Box consists of a PC-based computer that is housed in a ruggedized aluminum enclosure. Any maintenance or hardware upgrades can be completed after removing the bottom cover plate.

**Warning!** Do not remove the ruggedized aluminum covers until verifying that no power is flowing within the computer. Power must be switched off and the power cord must be unplugged. Take care in order to avoid injury or damage to the equipment.



## 3.2 Installing the Storage Device and Memory

The In-Vehicle Computing Box can only use a mSATA as a storage device. Put the mSATA into the slot and insert the RAM into the 200-pin SODIMM socket on the main board.

## 3.3 Installing Optional Accessories

Optional accessories, like RAM mount kits or other functional modules are available for purchase to complement TREK-570. The following are instructions for accessory installation.

### 3.3.1 Installing TREK-570 Peripheral Modules

There are 6 screws on the bottom of TREK-570 if you want to install the peripherals in TREK-570 please use M2 type screw to open the system.



Figure 3.1 Install peripheral in the system

### 3.3.2 Installing the MiniPCle Type WWAN, SIM Card and Coin Battery

The WWAN module is on the Mini PCIe slot can be easily installed, just undo the 6 screws from the bottom cover to install WWAN, SIM card, and RTC Coin battery

### 3.3.3 GPS Module

The GPS module had been installed on-board.

## 3.4 Paired with TREK-303 Specifications

See Appendix A

TREK-570 provides 3 display function (HDMI, VGA function and LCD to connect with TREK-303), it can output different content or clone output. 2 of 3 displays can display simultaneously in OS.





# Chapter 4

## Jumper Settings and Connectors

This chapter explains how to set up the In-Vehicle Computing Box hardware, including instructions on setting jumpers and connecting peripherals, and how to set switches and read indicators.

Be sure to read all the safety precautions before beginning the installation procedure.

Sections include:

- Setting Jumpers and Switches
- Jumpers Setting

## 4.1 Setting Jumpers and Switches

It is possible to configure the In-Vehicle Computing Box to match the needs of the application by resetting the jumpers. A jumper is the simplest kind of electrical switch. It consists of two metal pins and a small metal clip, often protected by a plastic cover that slides over the pins to connect them. To “close” a jumper, connect the pins with the clip. To “open” a jumper, remove the clip. Sometimes a jumper has three pins, labeled 1, 2, and 3. In this case, connect either pins 1 and 2, or pins 2 and 3.

---

### JP1: Car Battery Mode

1-2	2-3
12V	24V

default: 1-2

---

### SW1: PCIe mini card(CN22) mode select

ON	WLAN
OFF	WWAN

default: ON

---

### SW2: WWAN voice call setting

1	2	3	4	WWAN
ON	OFF	ON	OFF	MC809x
OFF	ON	OFF	ON	MC73x4

default: OFF-ON-OFF-ON (for MC73X4)

---

### SW3: CAN1/2 Termination

1	2	CAN1	CAN2
OFF	OFF	no termination	no termination
OFF	ON	no termination	Terminated
ON	OFF	Terminated	no termination
ON	ON	Terminated	Terminated

default: OFF-OFF

---

### J1: CMOS

1-2	Clear CMOS
2-3	Normal

default: 2-3

---

### SW4: WWAN Power Source Setting

1	2	3
3.3V	3.6V	3.8V

default: 2

---

**CN11: COM port pin9 setting**

---

1-2	2-3	4-5
+12V/0.5A	RING	+5V/0.5A

---

default: 2-3



# Chapter 5

## Pin Assignments

This chapter explains pin assignments on the TREK-570.

Sections include:

- Front/side Connector
- Power Connector
- Smart Display Connector
- RS232 Connectors
- DI/DO Connectors

## 5.1 Front Side Connectors

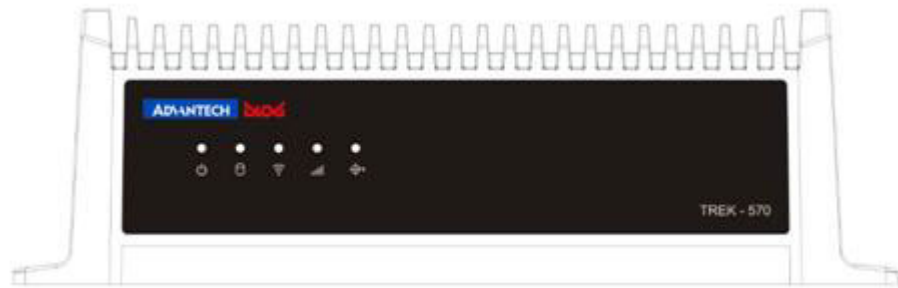

## 5.2 Rear Side Connectors

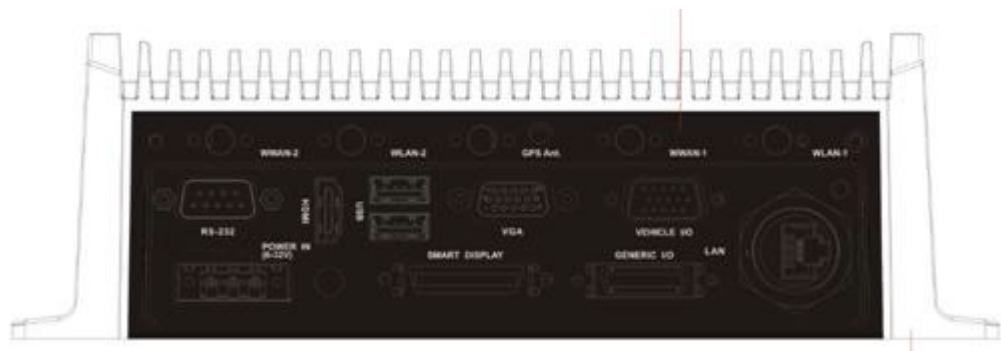

## 5.3 Power Connector (12/24V; 9 ~ 32V)

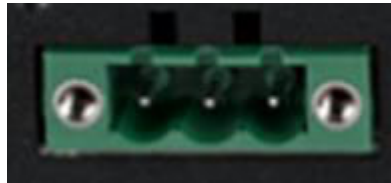

**Table 5.1: Power Connector**

Pin	Signal Depiction
1	Ground
2	Power Input (6 ~ 36 VDC; 18 ~ 58 VDC)
3	Acc Ignition Input

## 5.4 Smart Display Connector

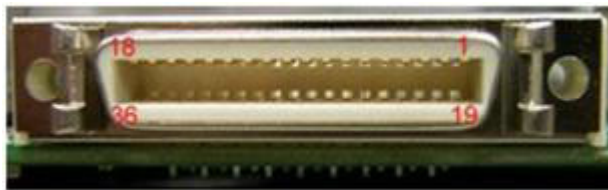

**Table 5.2: Smart Display Connector**

Pin	Signal	Pin	Signal
1	Backlight Enable output #	2	Panel Power Enable output #
3	LVDS Ground	4	Reset Button Input #
5	LVDS Clock +	6	LVDS Clock -
7	LVDS Ground	8	LVDS Ground
9	LVDS Data2 +	10	LVDS Data2 -
11	RS232 TXD1 #	12	RS232 RXD1 #
13	LVDS Data1 +	14	LVDS Data1 -
15	LVDS Ground	16	LVDS Ground
17	LVDS Data0 +	18	LVDS Data0 -
19	USB D-	20	USB D+
21	USB Ground	22	USB Ground
23	+12 V <sub>DC</sub> output (+/- 5%, max 1A)	24	+12 V <sub>DC</sub> output (+/- 5%, max 1A)
25	+12 V <sub>DC</sub> output (+/- 5%, max 1A)	26	+12 V <sub>DC</sub> output (+/- 5%, max 1A)
27	Power Ground	28	Power Ground
29	Power Ground	30	Power Ground
31	RS232 TXD2 #	32	RS232 RXD2 #
33	RS232 RTS2	34	Power Button Input #
35	Audio Ground	36	Mono. Line-out

**Note!** +12 VDC output ( $\pm 5\%$ , Total max. 1.5A)



## 5.5 RS-232 Connector (COM3)

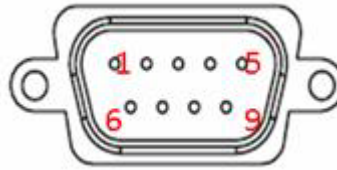

**Table 5.3: RS232 Connector(COM3)**

Pin	Signal Depiction	Pin	Signal Depiction
1	RS-232 DCD	2	RS-232 RXD
3	RS-232 TXD	4	RS-232 DTR
5	RS-232 Ground	6	RS-232 DSR
7	RS-232 RTS	8	RS-232 CTS
9	RS-232 RI / +5 V (max. 500 mA) /+V12 (max. 250 mA)		

## 5.6 Vehicle I/O

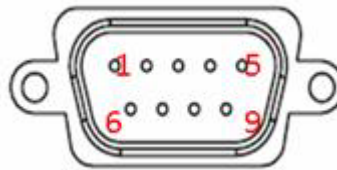

**Table 5.4: Vehicle I/O**

Pin	Signal
1	CAN_L
2	CAN_H
3	GND
4	J1708_DN
5	J1708_DP
6	NC
7	DGND
8	ODB_CAN_L
9	ODB_CAN_H
10	DGND
11	RS-485+
12	NC
13	RS-485-
14	NC
15	NC



## 5.7 Generic I/O Connector

**Table 5.5: Generic I/O Connector**

Pin	Signal
1	DI1
2	DI2
3	DI3
4	DI4
5	GND_DI
6	ISO_RELAYOUT3
7	ISO_RELAYOUT4
8	GND_GND
9	GND_CVBS
10	CVBS
11	GND_AUD
12	MIC_IN
13	LINE_OUT
14	ISO_RELAYOUT1
15	ISO_RELAYOUT2
16	GND_DO
17	COMA_232_RXD
18	COMA_232_TXD
19	COMA_232_RTS#
20	COMA_232_CTS#
21	GND_COMA
22	COMB_232_RXD
23	COMB_232_TXD
24	COMB_232_RTS#
25	COMB_232_CTS#
26	GND_COMB



# Chapter 6

## Software Demo Utility Setup

This appendix explains the software demo utility for TREK-570.

Sections include:

- Introduction
- How to Set up Demo Utility

## 6.1 Introduction

To make the hardware easier to access for programmers, Advantech has developed a demo utility in order to let customer test the functions on TREK-570. This document describes detailed information for each Advantech demo utility so that application developers can become more familiar with using them.

For technical support, contact Advantech application engineers worldwide. For news updates, visit our website: [www.advantech.com](http://www.advantech.com)

## 6.2 Execute VCIL Sample Code

TREK V3 VCIL Sample Code is demonstration of Vehicle Communication Interface Layer (VCIL) which let user easily to use vehicle protocol.

### 6.2.1 System Menu

TREK V3 VCIL Sample Code as below figure

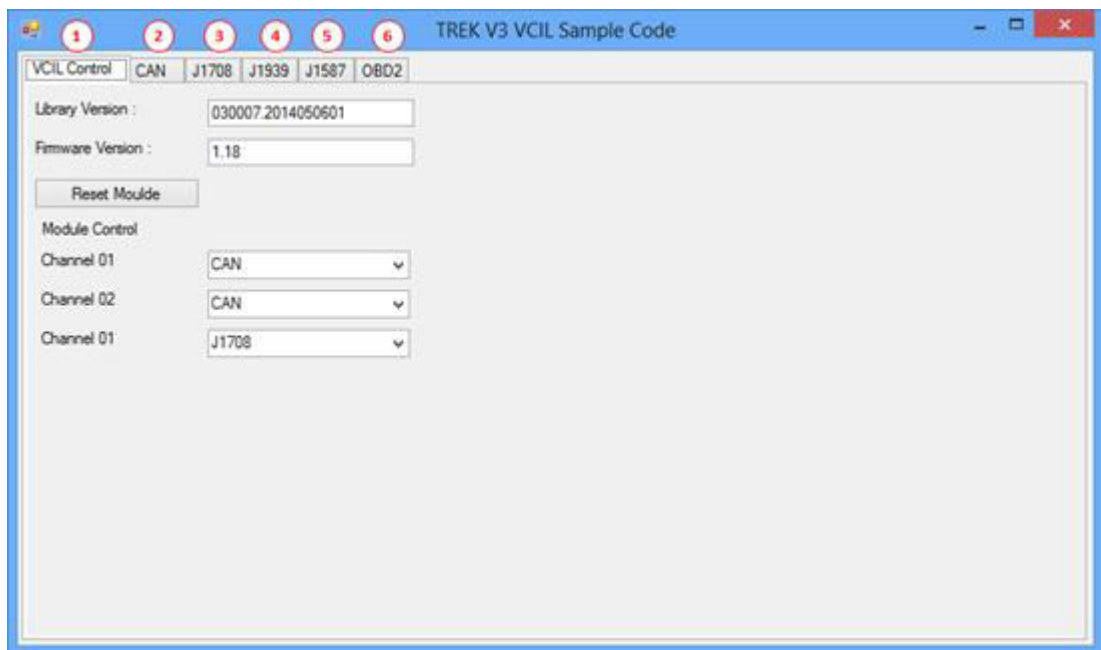

- VCIL Control page
- CAN page
- J1708 page
- J1939 page
- J1587 page
- OBD2 page

## VCIL Control Page

VCIL Control page as below figure

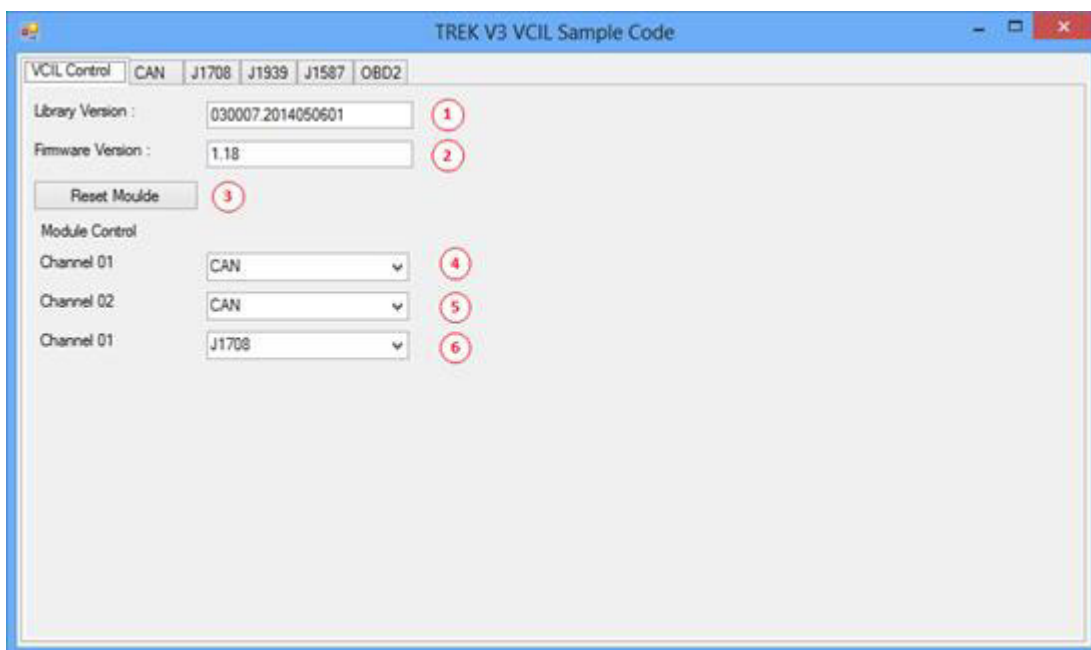

- Library Version
- Firmware Version
- Reset firmware to default
- (CAN/J1939/OBD2) Channel 1 bus type control
- (CAN/J1939/OBD2) Channel 2 bus type control
- (J1708/J1587) Channel 1 bus type control

**Note!** Each channel only can select one bus type at same time.



## CAN Page

CAN page as below figure

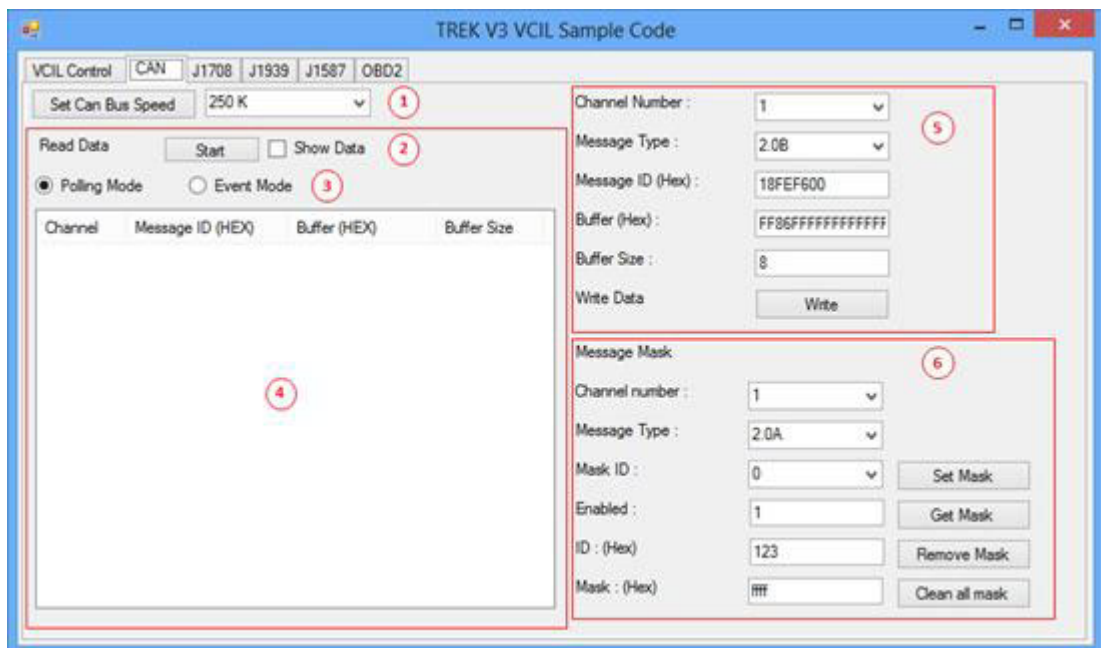

- Bus Speed
- Read Data control (Press "Start" to monitor bus to read)
- Read Data method
- Read Data list
- Write Data control
- CAN bus message mask control

## J1708 Page

J1708 page as below figure

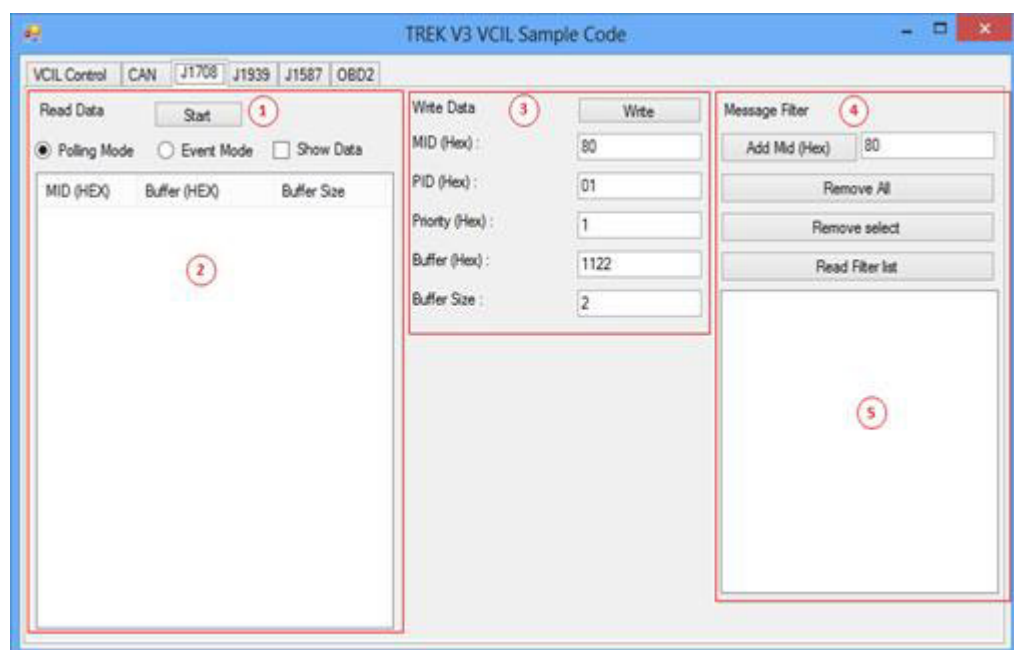

- Read Data control (Press "Start" to monitor bus to read)
- Read Data list
- Write Data control
- J1708 bus message filter control
- Message filter list

J1939 Page

J1939 page as below figure

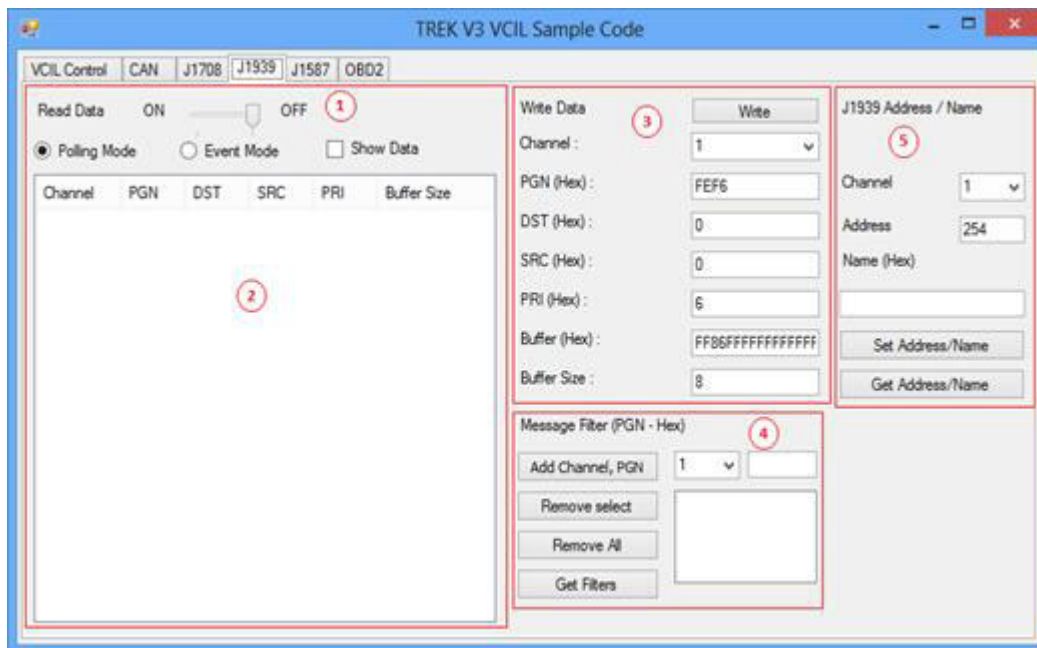

- Read Data control (Press "Start" to monitor bus to read)
- Read Data list
- Write Data control
- J1939 bus message filter control
- J1939 Address mapping

## J1587 Page

J1587 page as below figure

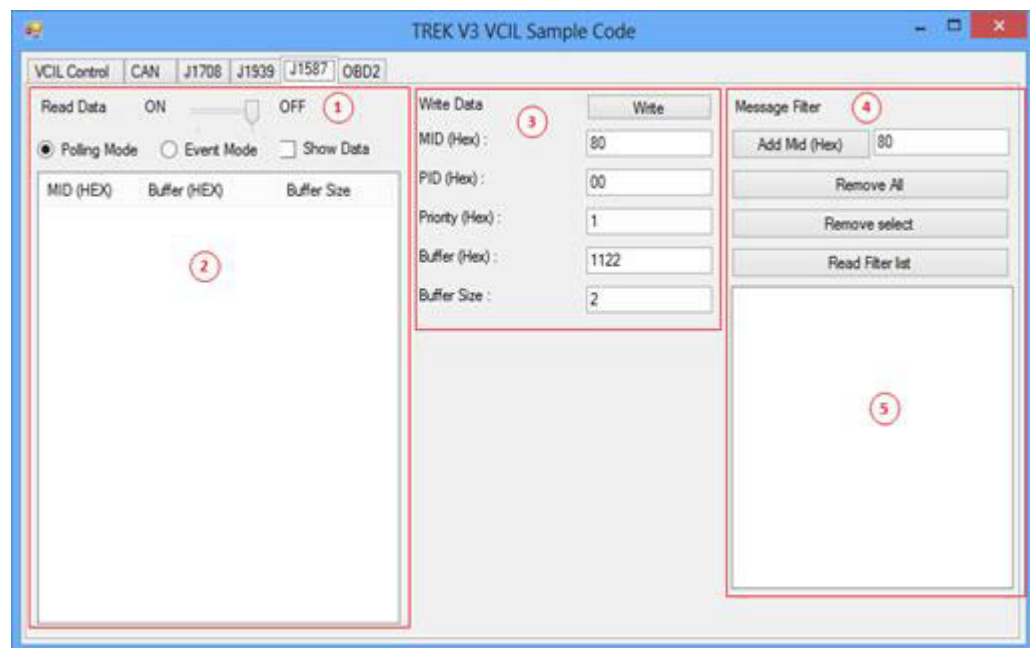

- Read Data control (Press "Start" to monitor bus to read)
- Read Data list
- Write Data control
- J1587 bus message filter control
- Message filter list

## ODB2 Page

ODB2 page as below figure

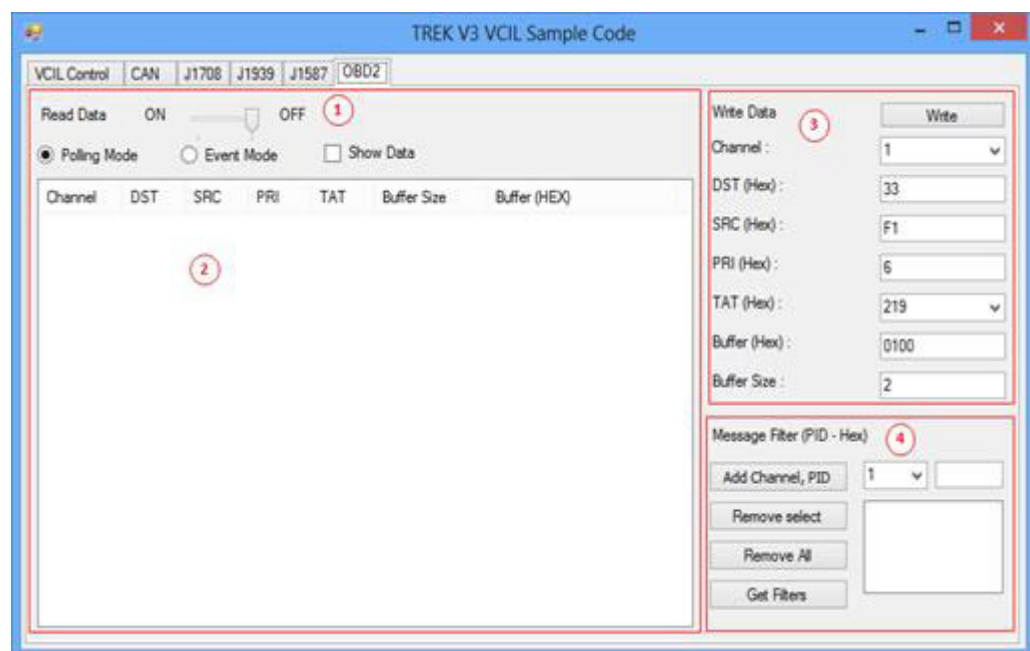

- Read Data control (Press "Start" to monitor bus to read)
- Read Data list



- Write Data control
- ODB2 bus message filter control

## 6.2.2 Testing VCIL

1. Opening "TREK\_V3\_Sample\_Code\_VCIL.exe"
2. Select VCIL port and speed for your platform. For example, select the port number 8 on TREK-674

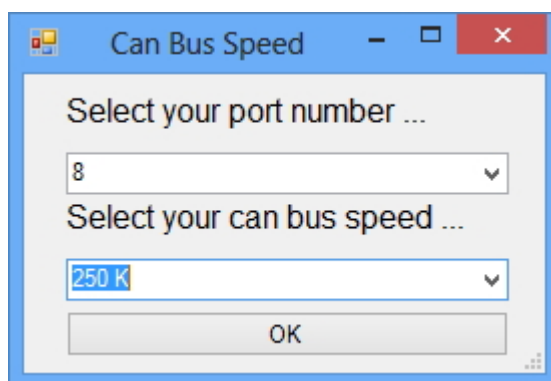

3. Selecting "VCIL Control" page as below figure



4. You should see the firmware version on this page when success opening VCIL.

## Bus Type Control

1. Selecting "VCIL Control" page
2. Press combo box on the channel which you want to configure as below figure



3. Selecting Bus type

**Note!** Each channel only can select one bus type at same time.



## Reset Module

1. Selecting "VCIL Control" page
2. Press "Reset Module" button as below figure

**Caution!** When reset module, all configure for each bus reset to default value.

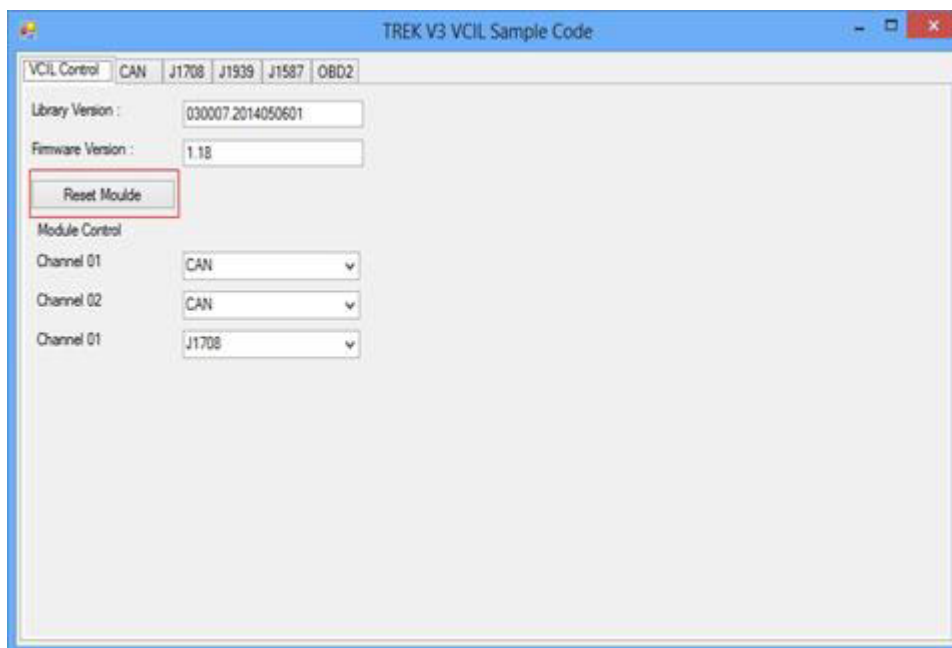

## 6.2.3 Testing CAN

1. Selecting "VCIL Control" page
2. Press combo box on the channel and select "CAN" as below figure

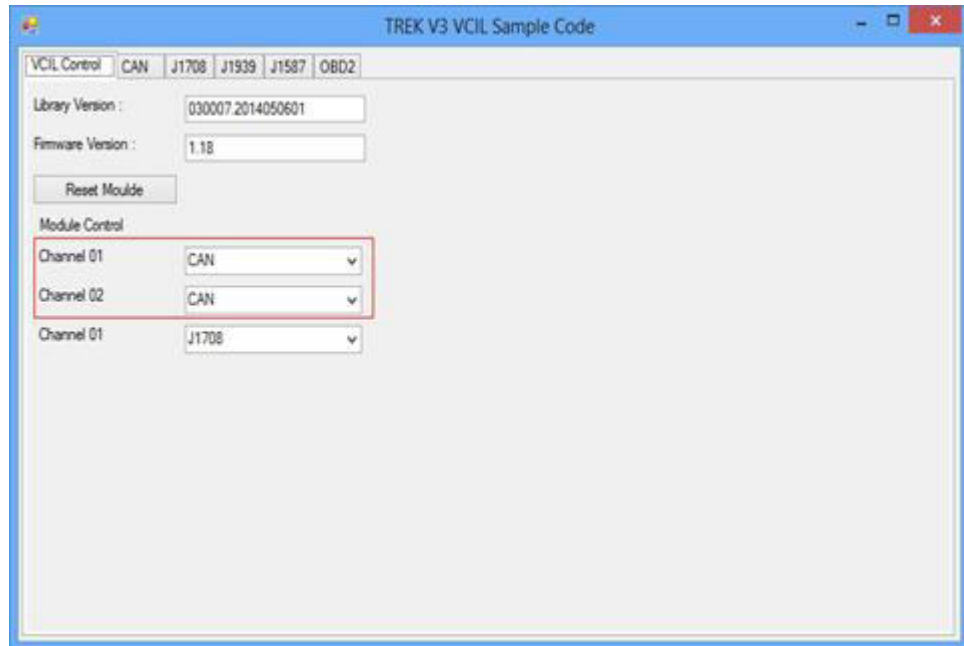

### Reading Data

1. Selecting "CAN" page as below figure

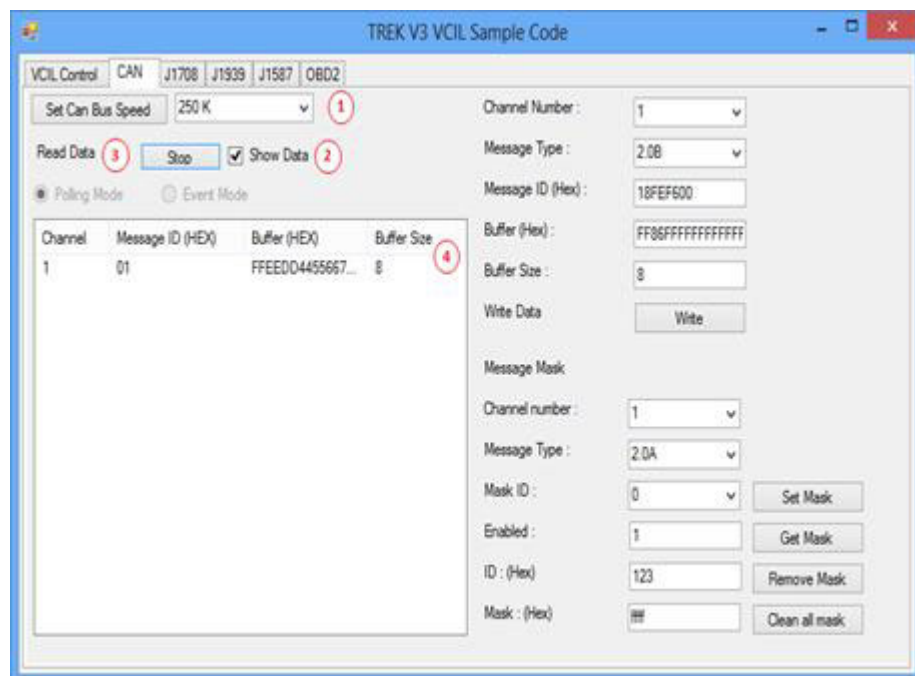

Set CAN bus speed. For example 250K

2. Checked "Show Data"
3. Press "Start" button to receive CAN bus data
4. You should see the data came from the CAN bus and show on the list

## Writing Data

1. Selecting "CAN" page as below figure

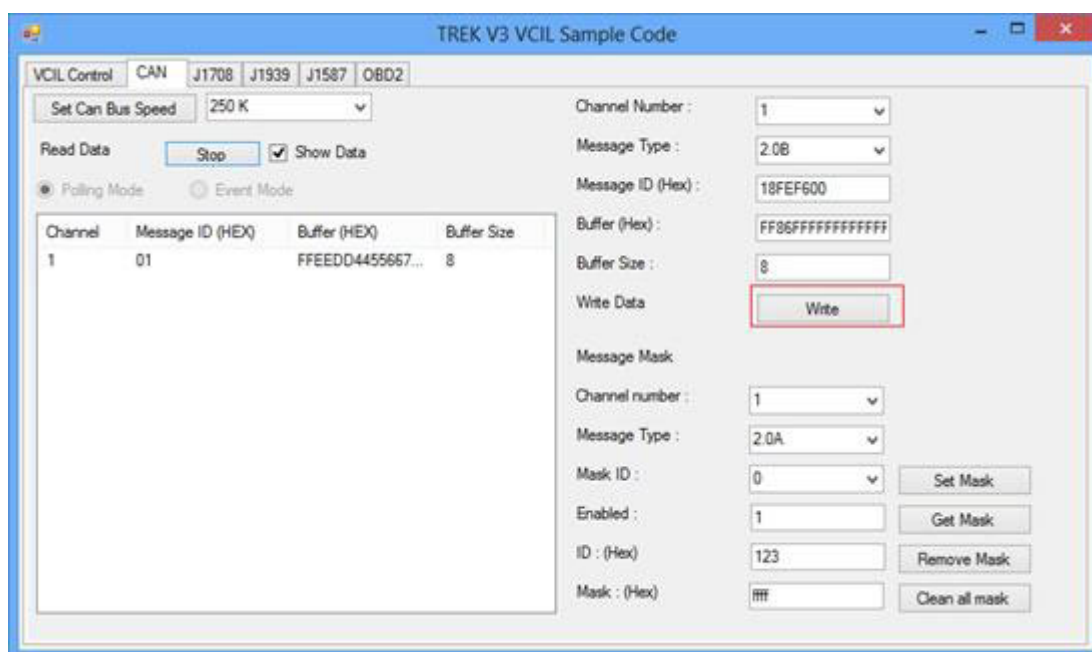

Set CAN bus speed. For example 250K

2. Filling the CAN bus data prepare to send
3. Press "Write" button to send CAN bus data as above figure
4. You should see the data on the receiver

## Testing Message Mask

1. Selecting "VCIL Control" page
2. Press combo box on the channel and select "CAN + Mask" as below figure

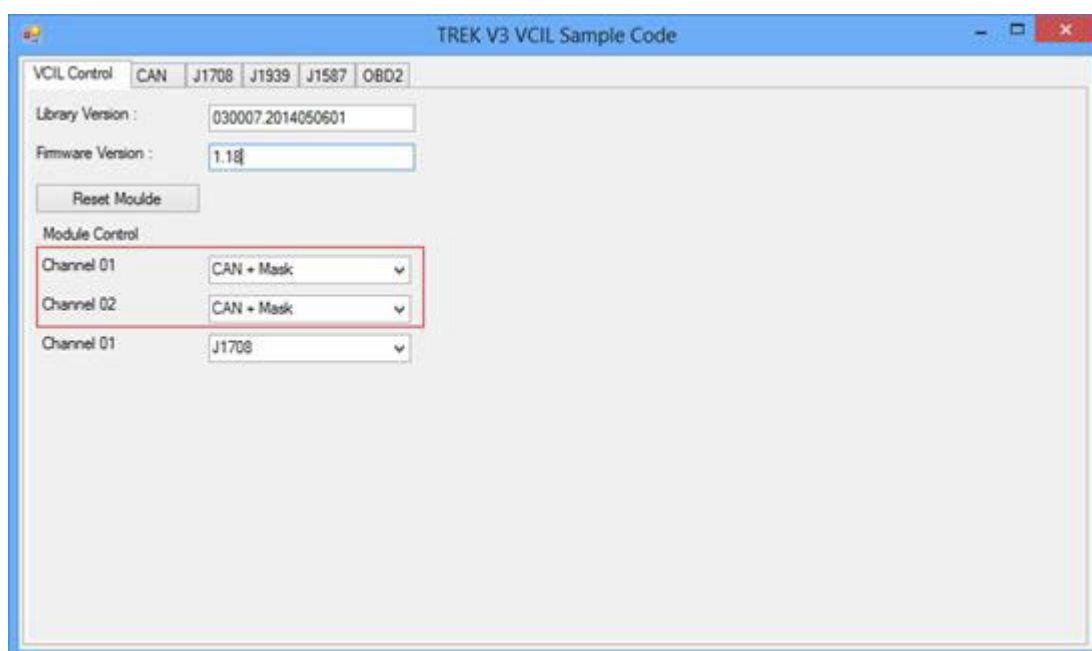

## Set Mask

1. Selecting "CAN" page as below figure

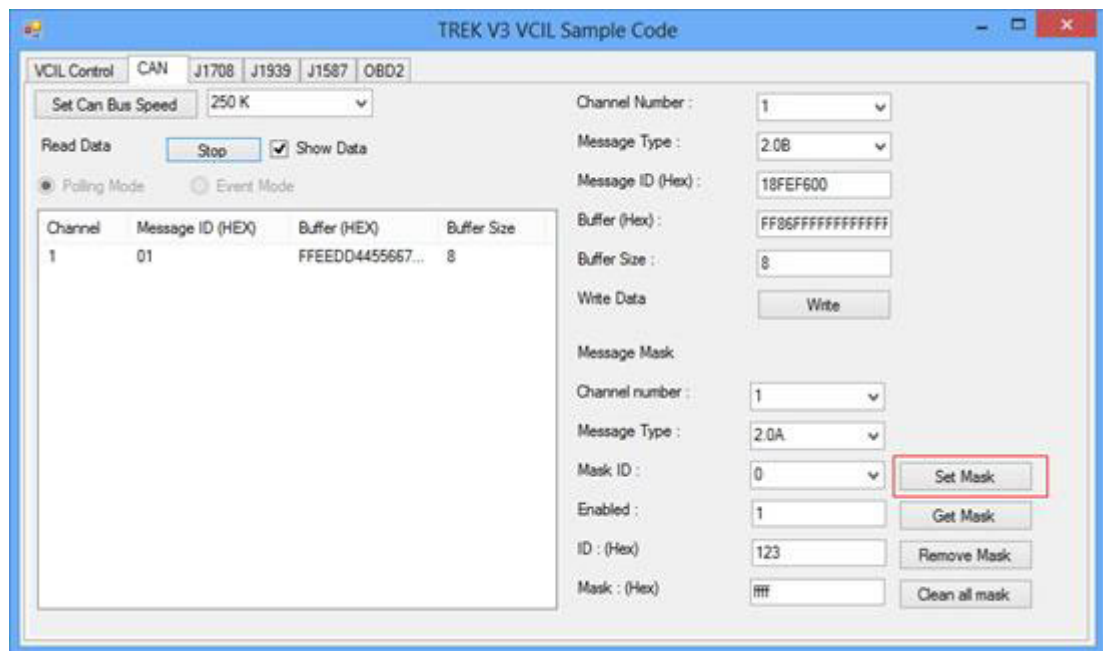

Set CAN bus speed. For example 250K

2. Configure the Message mask
3. Press "Set Mask" button to apply the mask to bus
4. You should see the mask was applied on the bus.
5. If you set a mask to bus. You should not see the specified CAN ID on the read data list if the ID not passed for the mask

Mask Rule:

The CAN Message ID & operator "Mask" equal the "ID" & operator "Mask" PASS

The CAN Message ID & operator "Mask" not equal the "ID" & operator "Mask" NO PASS

For example, as above figure setting. If the input CAN Message ID is 0x123, the result passed. Since 0x123 & 0xffff equal the ID 0x123 & 0xffff.

If the input CAN data ID is 0x120, the result not passed. Since 0x120 & 0xffff not equal the ID 0x123 & 0xffff.

## 6.2.4 Testing J1939

1. Selecting "VCIL Control" page
2. Press combo box on the channel and select "J1939" as below figure

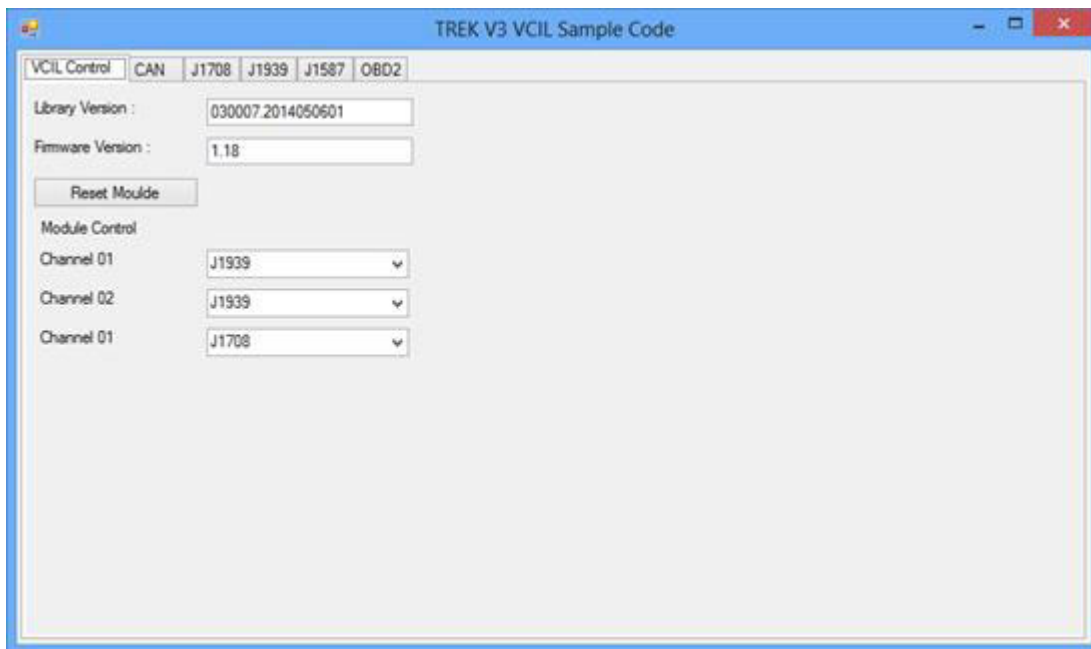

### Reading Data

1. Selecting "J1939" page as below figure

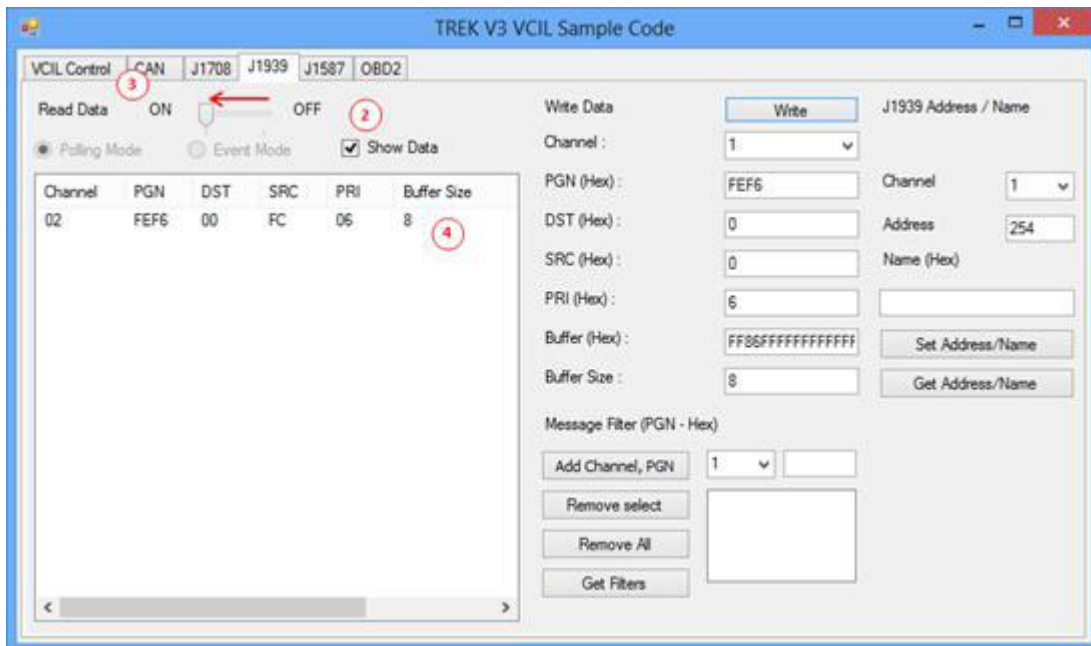

2. Checked "Show Data"
3. Pull TrackBar "ON" to receive J1939 data
4. You should see the data came from the J1939 and show on the list

## Writing Data

1. Selecting "J1939" page as below figure

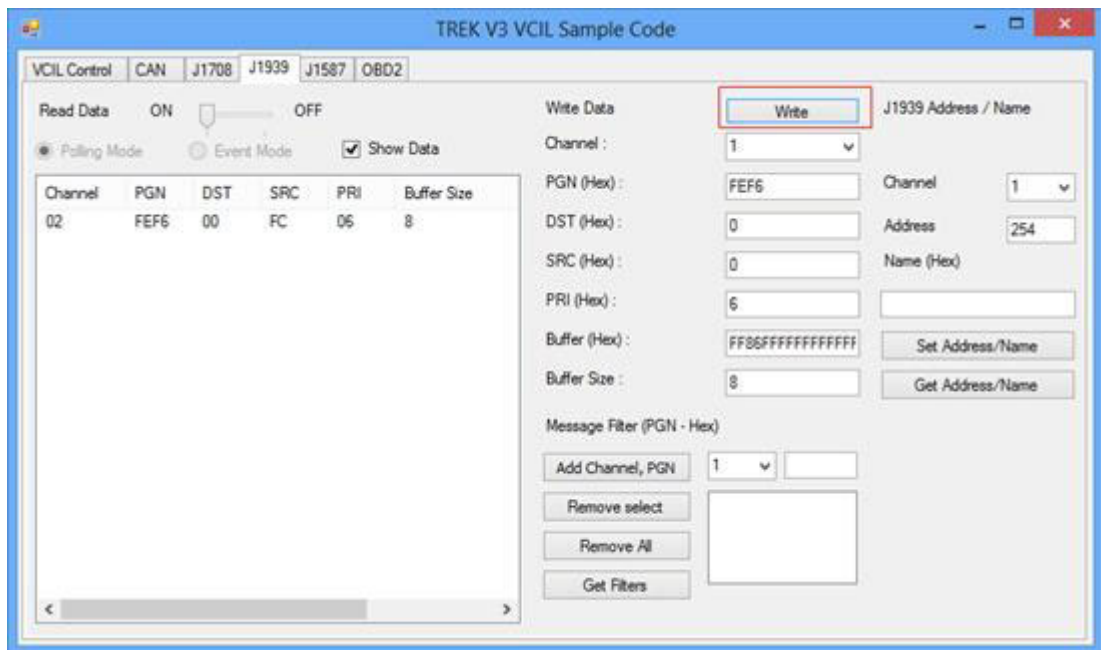

2. Filling the J1939 data prepare to send
3. Press "Write" button to send J1939 data as above figure
4. You should see the data on the receiver

## Testing Message Filter

1. Selecting "VCIL Control" page
2. Press combo box on the channel and select "J1939 + Mask" as below figure

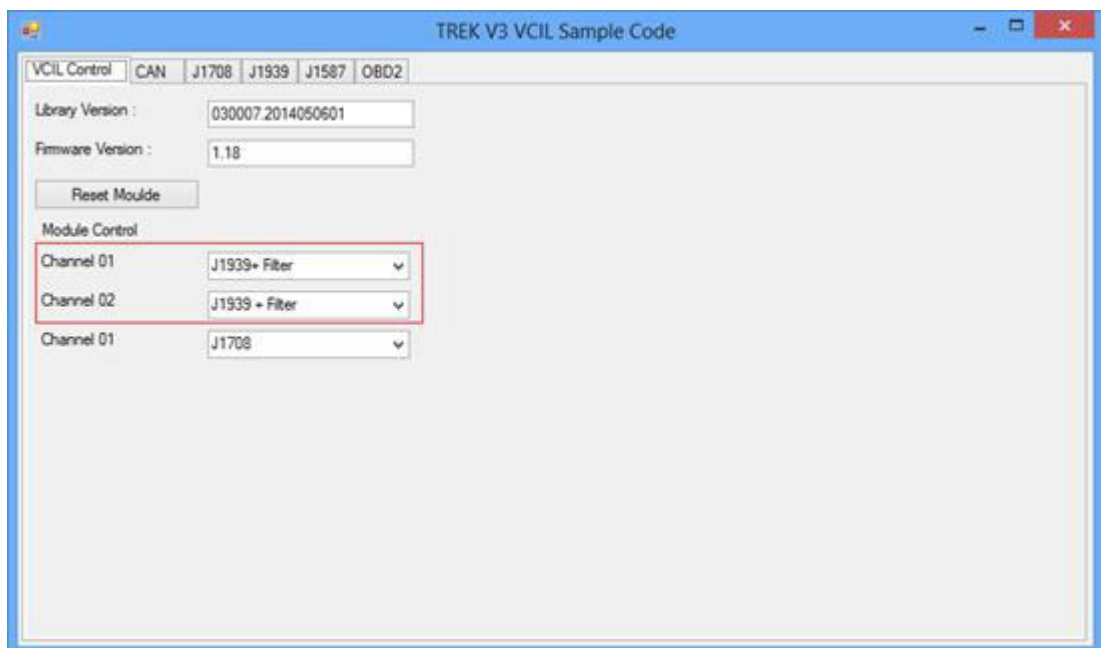



## Set Message Filter

1. Selecting "J1939" page as below figure

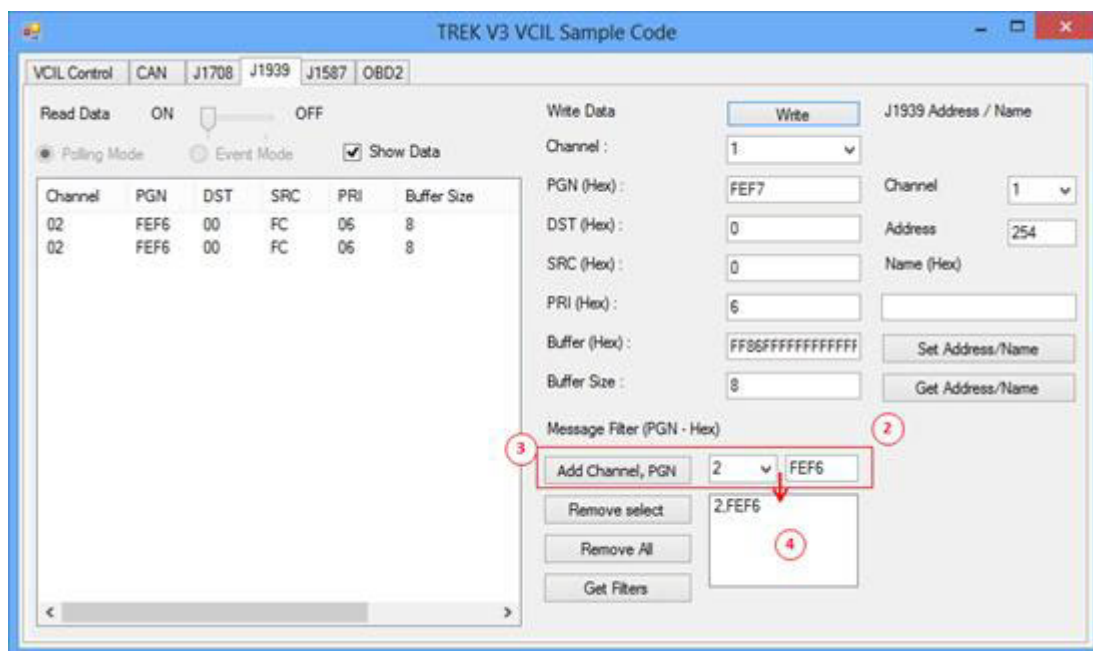

2. Select Channel and specified PGN to filter
3. Press "Add Channel, PGN" button to add the rule to filter
4. You should see the filter was applied on the bus
5. The system ignores all PGN is not on the list

For example, as above figure setting. The system can receive the PGN equal to 0xFE6, otherwise no.

## 6.2.5 Testing OBD2

1. Selecting "VCIL Control" page
2. Press combo box on the channel and select "OBD2" as below figure

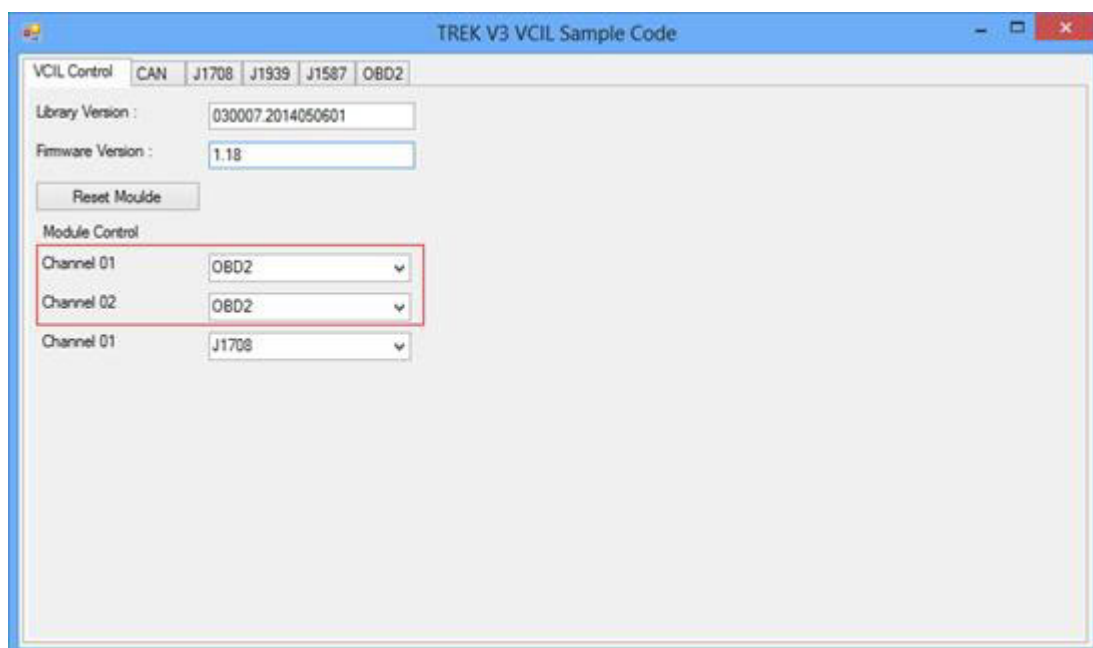

## Reading Data

1. Selecting "ODB2" page as below figure

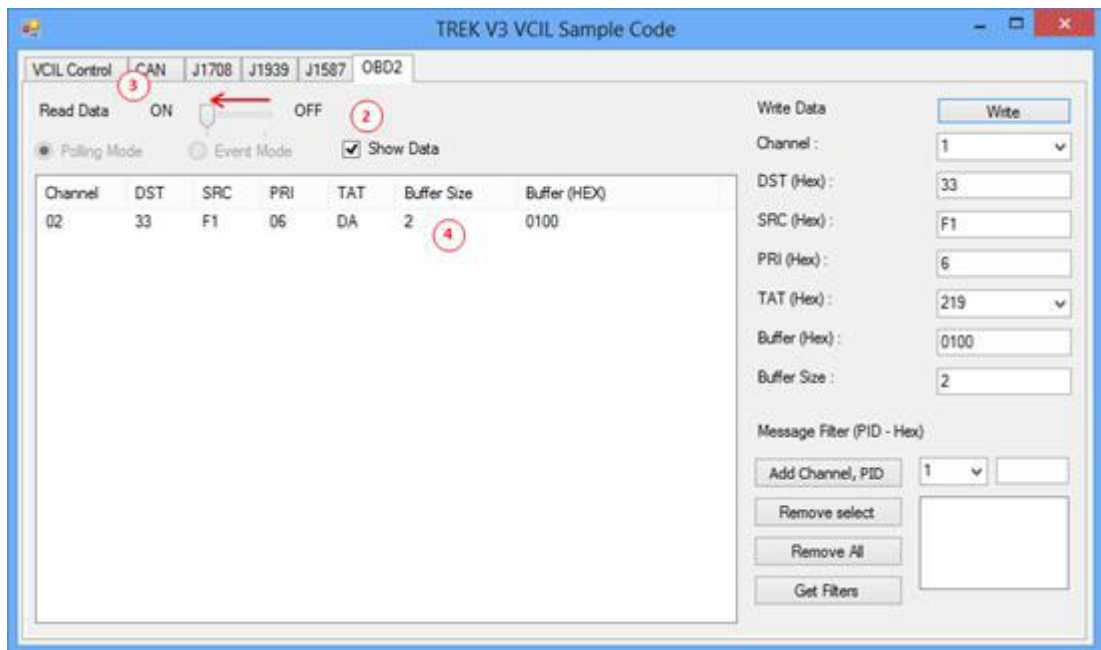

2. Checked "Show Data"
3. Pull TrackBar "ON" to receive ODB2 data
4. You should see the data came from the ODB2 and show on the list

## Writing Data

1. Selecting "ODB2" page as below figure

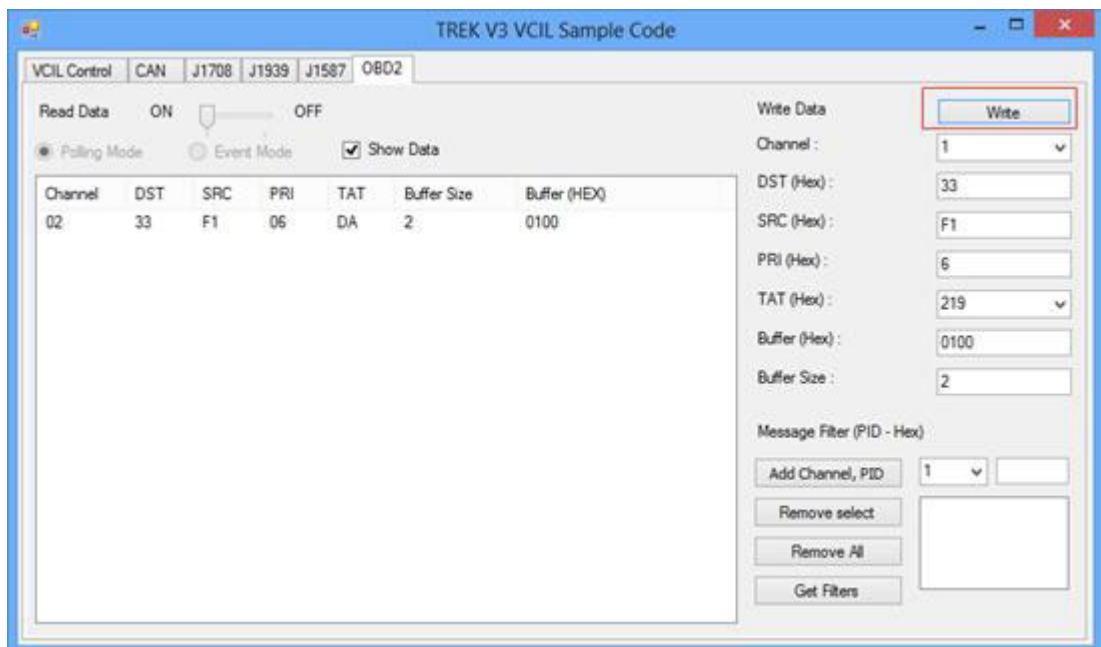

2. Filling the ODB2 data prepare to send
3. Press "Write" button to send ODB2 data as above figure
4. You should see the data on the receiver

### Testing Message Filter

1. Selecting "VCIL Control" page
2. Press combo box on the channel and select "OBD2 + Mask" as below figure

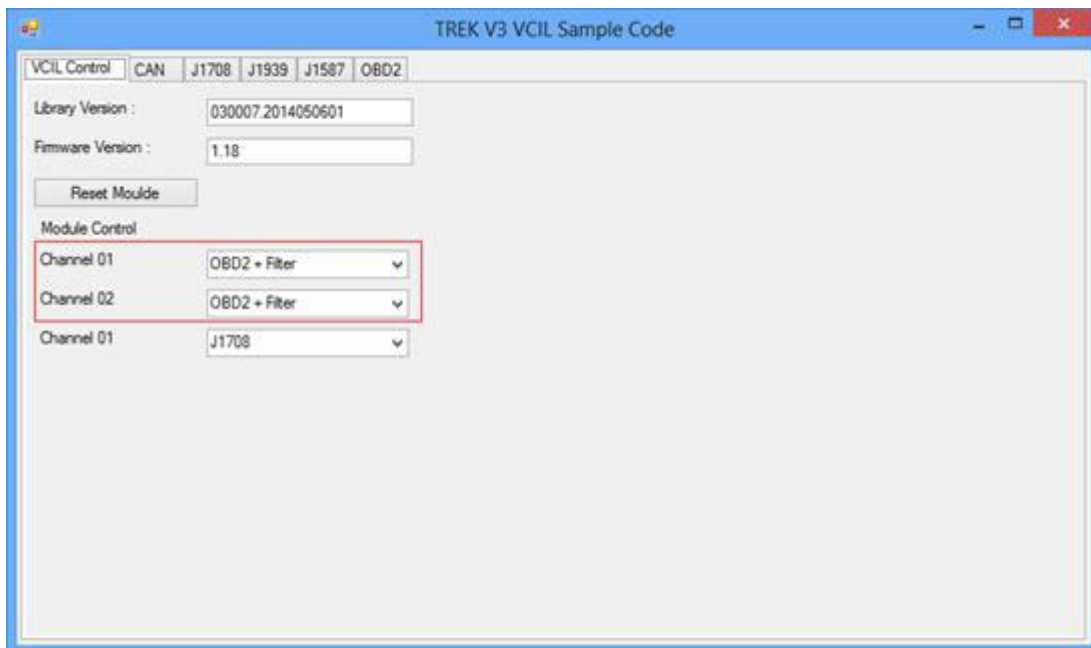

### Set Message Filter

1. Selecting "OBD2" page as below figure

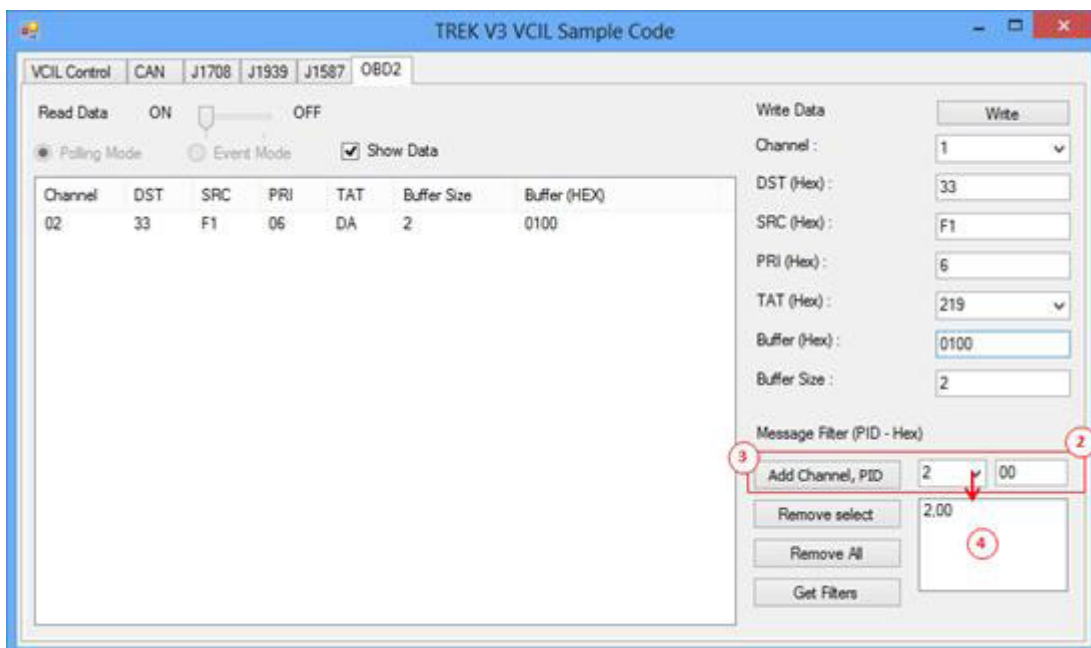

2. Select Channel and specified PID to filter
3. Press "Add Channel, PID" button to add the rule to filter
4. You should see the filter was applied on the bus
5. The system ignores all PID is not on the list

For example, as above figure setting. The system can receive the PID equal to 0x00, otherwise no.

## 6.2.6 Testing J1708

1. Selecting "VCIL Control" page
2. Press combo box on the channel and select "J1708" as below figure

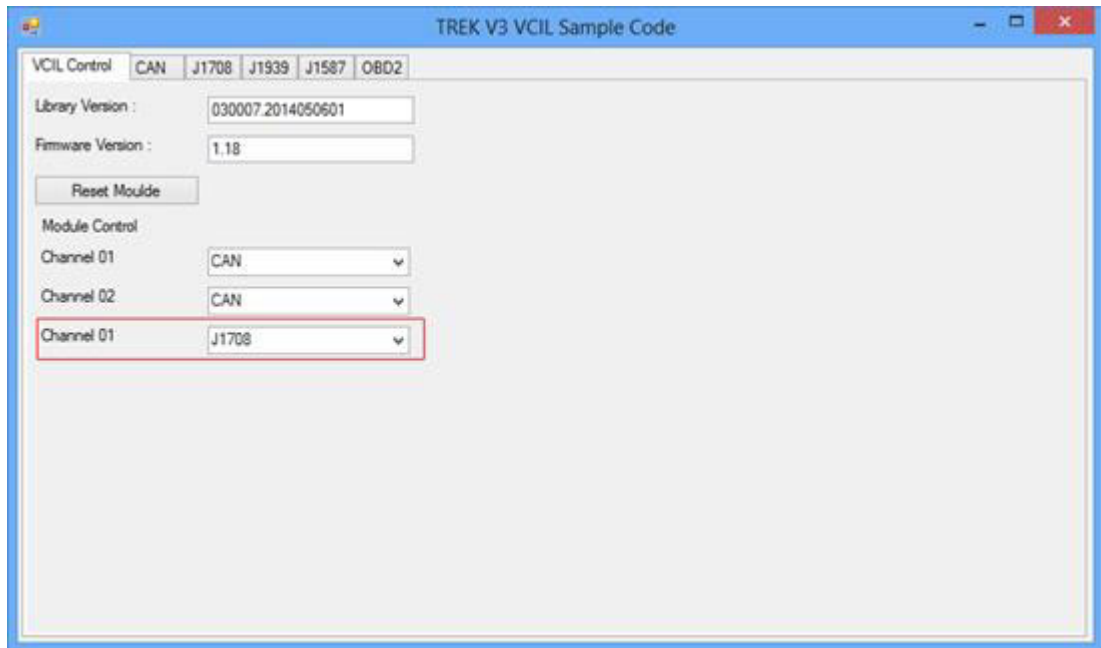

### Reading Data

1. Selecting "J1708" page as below figure

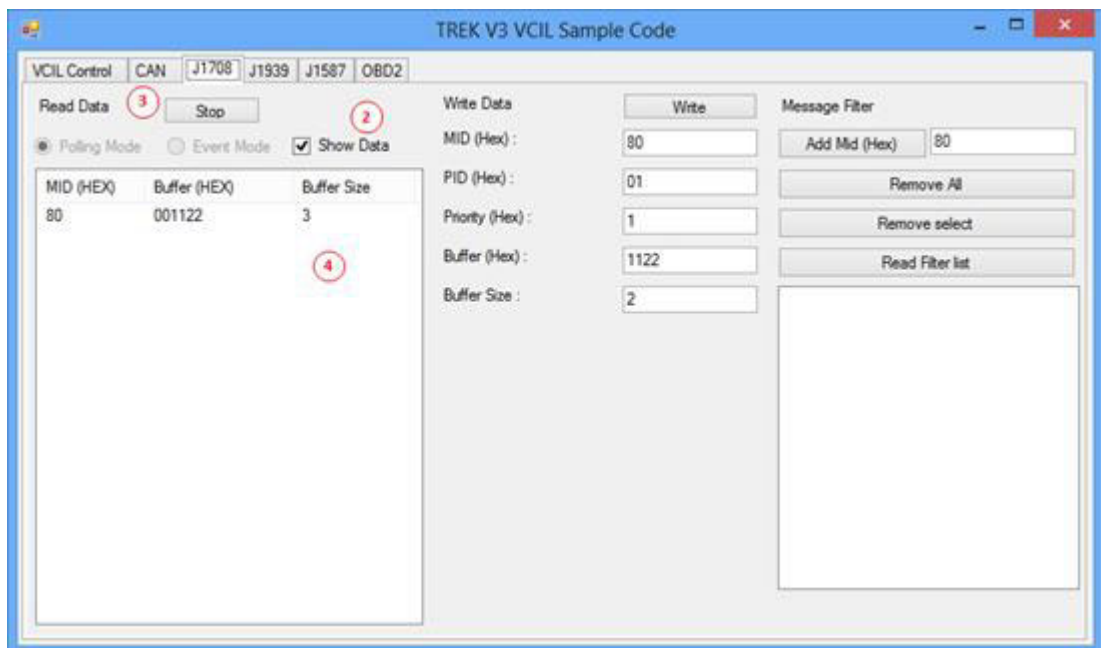

2. Checked "Show Data"
3. Press "Start" button to receive J1708 data
4. You should see the data came from the J1708 and show on the list

## Writing Data

1. Selecting "J1708" page as below figure

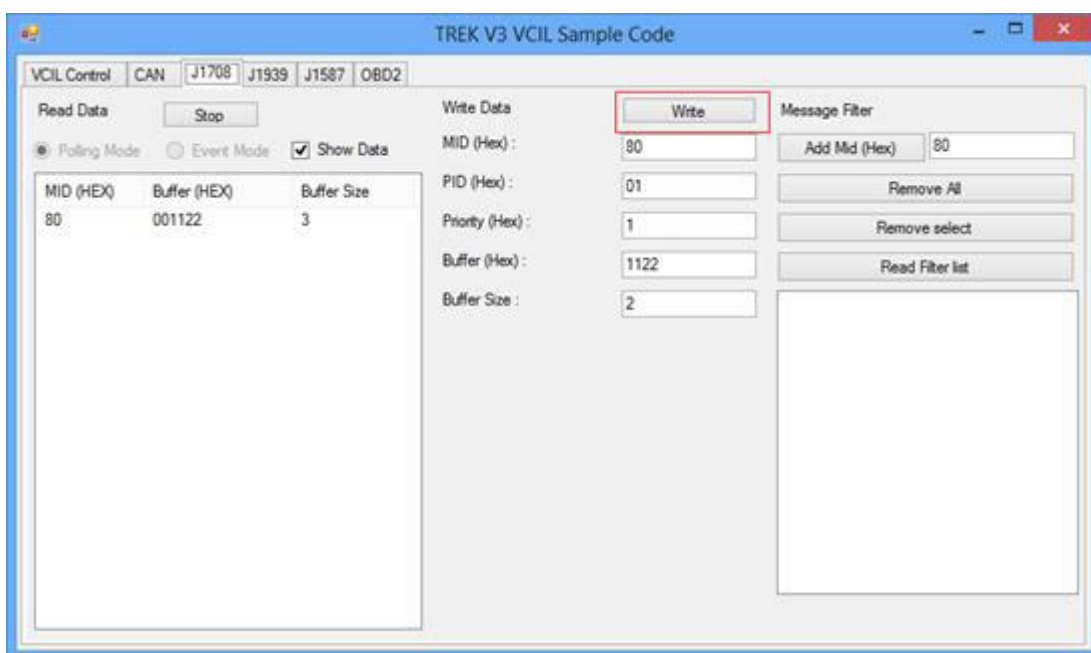

2. Filling the J1708 data prepare to send
3. Press "Write" button to send J1708 data as above figure
4. You should see the data on the receiver

## Testing Message Filter

1. Selecting "J1708" page as below figure

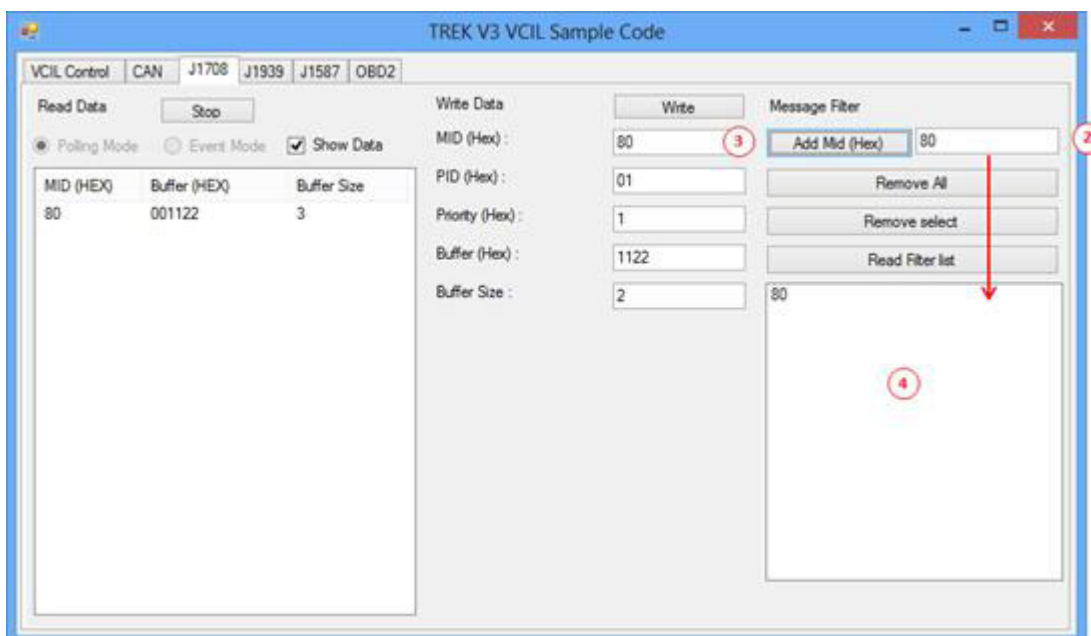

2. Enter specified MID to filter
3. Press "Add MID" button to add the rule to filter
4. You should see the filter was applied on the bus
5. The system ignores all MID is not on the list

## 6.2.7 Testing J1587

1. Selecting "VCIL Control" page
2. Press combo box on the channel and select "J1587" as below figure

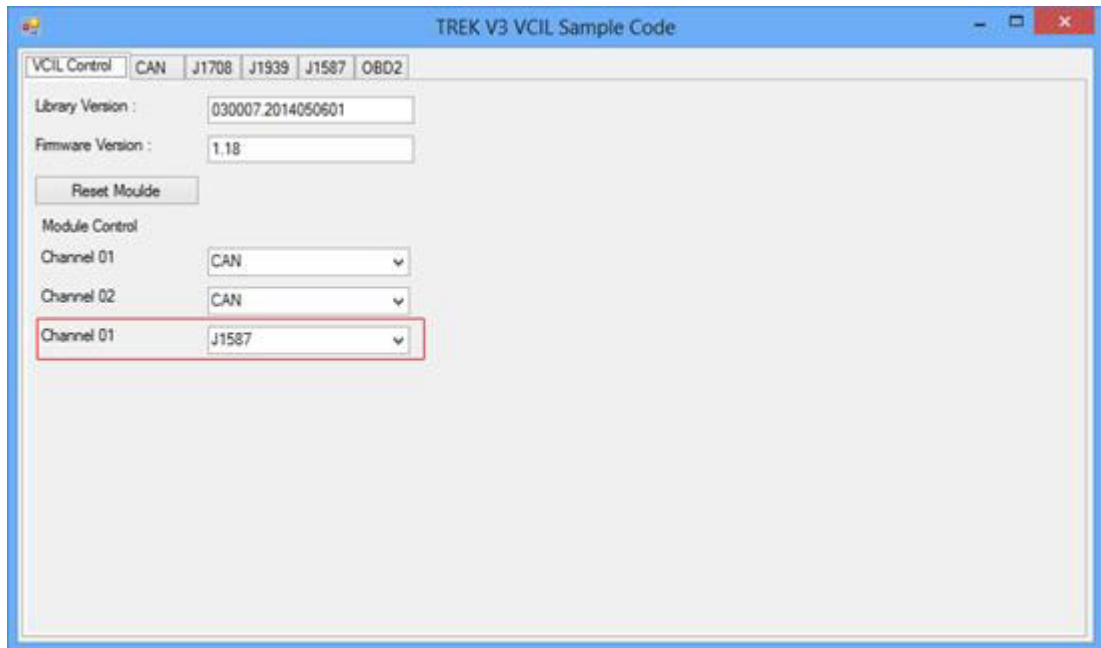

### Reading Data

1. Selecting "J1587" page as below figure

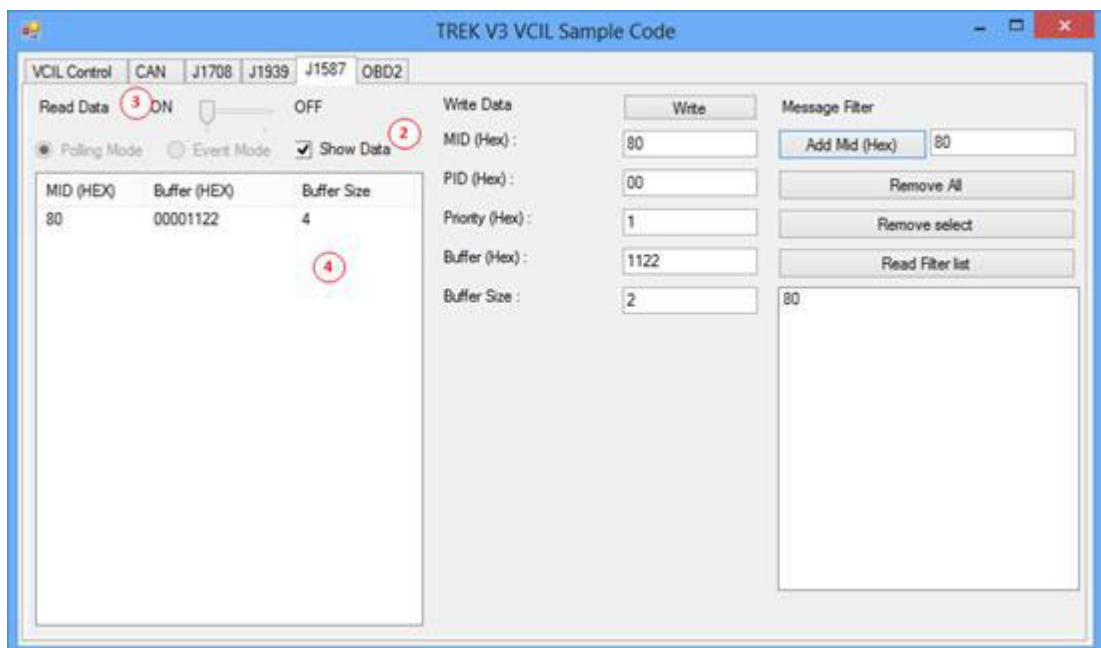

2. Checked "Show Data"
3. Press "Start" button to receive J1587 data
4. You should see the data came from the J1587 and show on the list

## Writing Data

1. Selecting "J1587" page as below figure

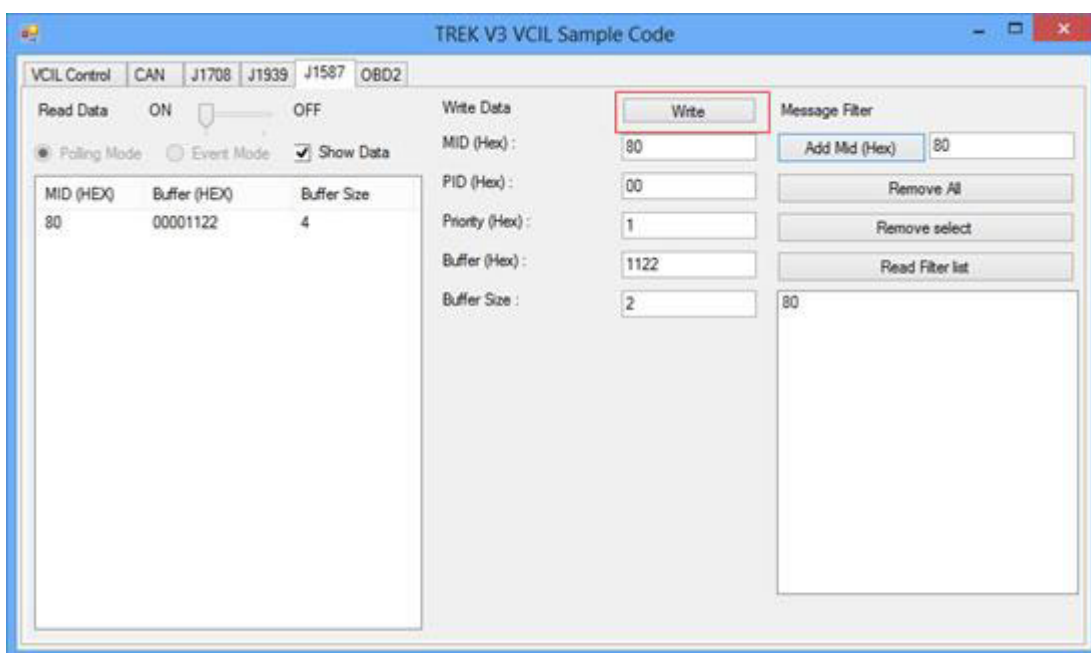

2. Filling the J1587 data prepare to send
3. Press "Write" button to send J1587 data as above figure
4. You should see the data on the receiver

## Testing Message Filter

1. Selecting "J1587" page as below figure

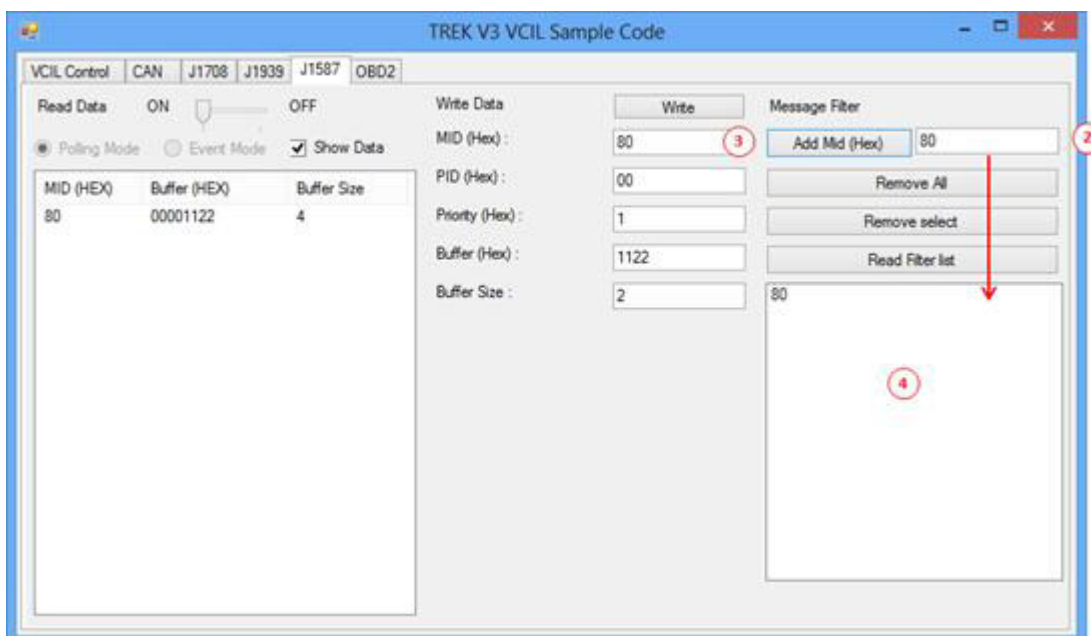

2. Enter specified MID to filter
3. Press "Add MID" button to add the rule to filter
4. You should see the filter was applied on the bus
5. The system ignores all MID is not on the list

## 6.3 Vehicle Power Management

### 6.3.1 Power Management Mechanism

The feature of Vehicle Power Management (VPM) is provided for users to fulfill the special requirements on in-vehicle applications.

- Ignition on/off
  - Turn on the system by ignition  
For the cases of in-vehicle applications, an ignition signal is often used to turn on or shutdown the system. When the system is in an OFF state and ignition is turn ON, the VPM controller will countdown ON\_DELAY; once it counts to zero, the system will be turned on.
  - Shutdown the system by ignition  
When the system is powered on and the ignition is turn off, the OFF\_EVENT\_DELAY will start to count down. During this stage, if the ignition is back to ON, the VPM controller will stop countdown and reset the OFF\_EVENT\_DELAY value. If OFF\_EVENT\_DELAY counts to zero, the VPM controller will send an event (power button press) to the system and start to count HARD\_OFF\_DELAY. Application programs could watch this event to do pre-defined tasks, like storing data and preparing to turn off the system.  
Once going into the HARD\_OFF\_DELAY stage, this process will be irreversible. And if HARD\_OFF\_DELAY counts to zero, the system power will be cut off abruptly.
- Low battery protection  
To avoid draining out the car battery, low-battery protection is involved to ensure the car battery is capable to start the vehicle. When the system is ON, the VPM controller will monitor the car battery voltage. If the battery voltage is lower than a programmable threshold (LOW\_THRESHOLD), the VPM controller will go into LOW\_DELAY stage and start to count down. During the stage of LOW\_DELAY countdown, if battery voltage is back above LOW\_THRESHOLD, the VPM controller will stop counting down and exit. If LOW\_DELAY counts to zero, the VPM controller will send an event (power button press) to notify the system, go into LOW\_HARD\_DELAY stage and start to count down. Once LOW\_HARD\_DELAY counts to zero, the VPM controller will cut off the system power abruptly to avoid draining out the car battery.

The table below lists the user programmable parameters for VPM features:

	Default value	Acceptable range
ON_DELAY	2 seconds	1 ~ 18000 seconds
OFF_EVENT_DELAY	5 seconds	1 ~ 18000 seconds
HARD_OFF_DELAY	60 seconds	1 ~ 18000 seconds
LOW_THRESHOLD (12V mode)	11.42 V	10.09 ~ 12.25 V
LOW_THRESHOLD (24V mode)	22.44 V	21.11 ~ 23.28 V
LOW_DELAY	30 seconds	1 ~ 3600 seconds
LOW_HARD_DELAY	60 seconds	1 ~ 3600 seconds



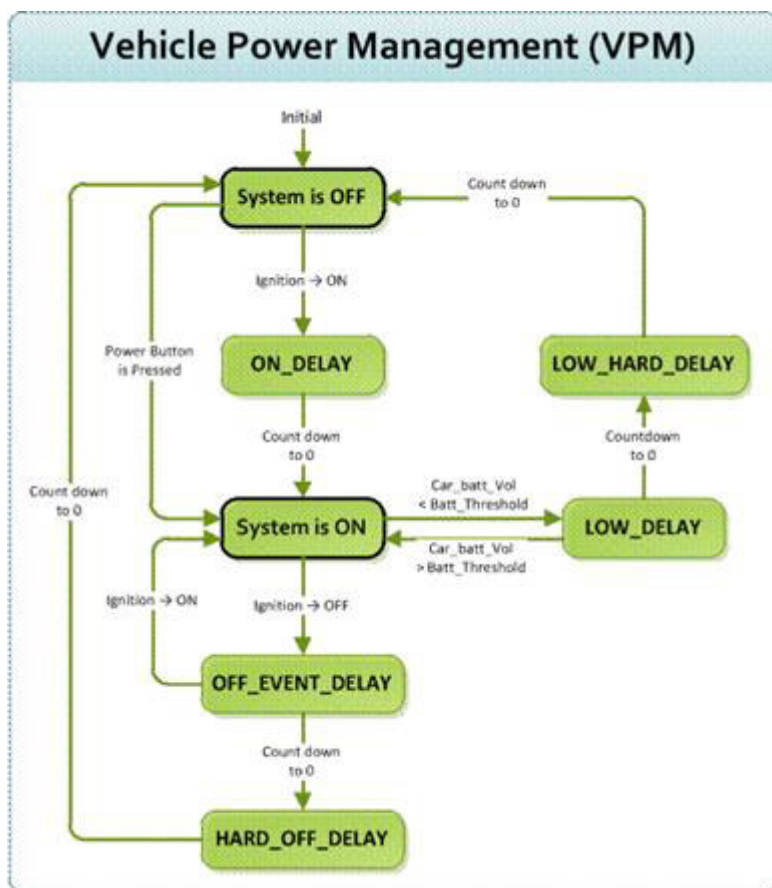

### 6.3.2 Power Management demo program

TREK V3 VPM Sample Code is demonstration of vehicle power management (VPM).

#### System Menu

- TREK V3 VPM Sample Code as below figure

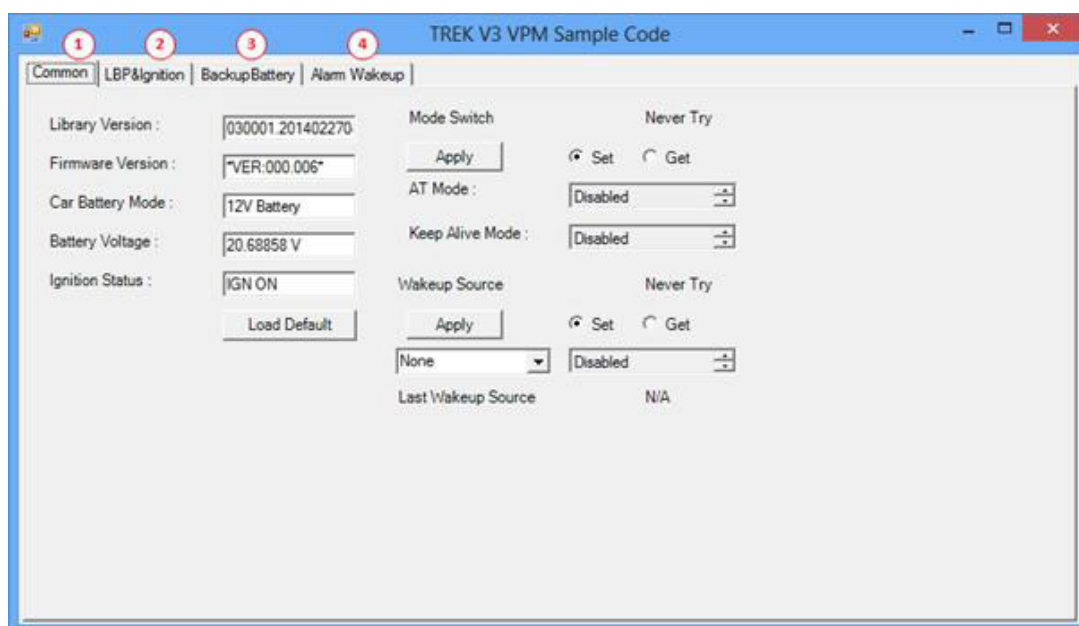

1. Common page

2. Low Battery Protection & Ignition Control page
3. Backup Battery Information page
4. Alarm Wakeup Control page

### Common page

- VPM Common page as below figure

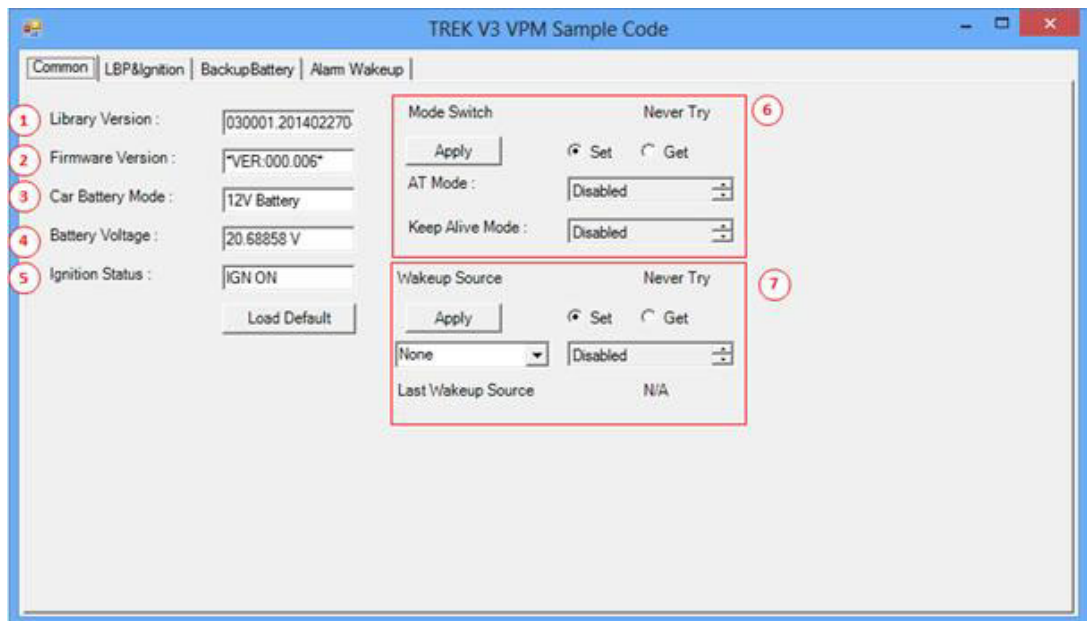

1. Library Version
  2. Firmware Version
  3. Car Battery Mode (Decide LBP what voltage mode to use)
  4. Current Battery Voltage
  5. Ignition Status
  6. Mode Control
  7. Wakeup Source Control
- Low Battery Protection & Ignition Control page

- VPM Low Battery Protection & Ignition Control page as below figure

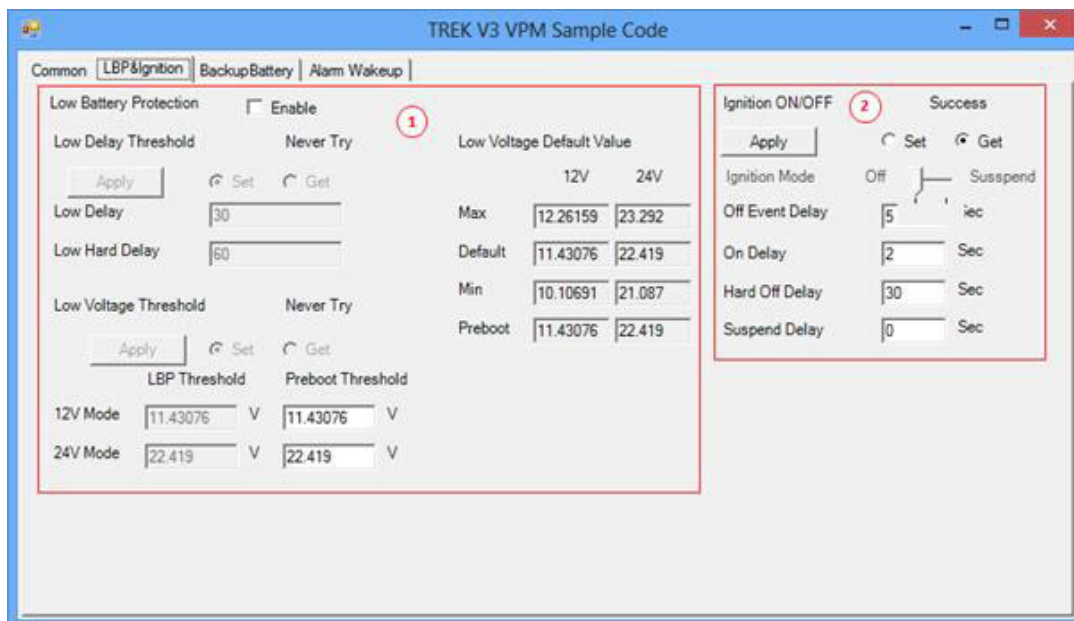

1. Low Battery Protection Control
  2. Ignition Control
- Backup Battery Information page

- VPM Common page as below figure

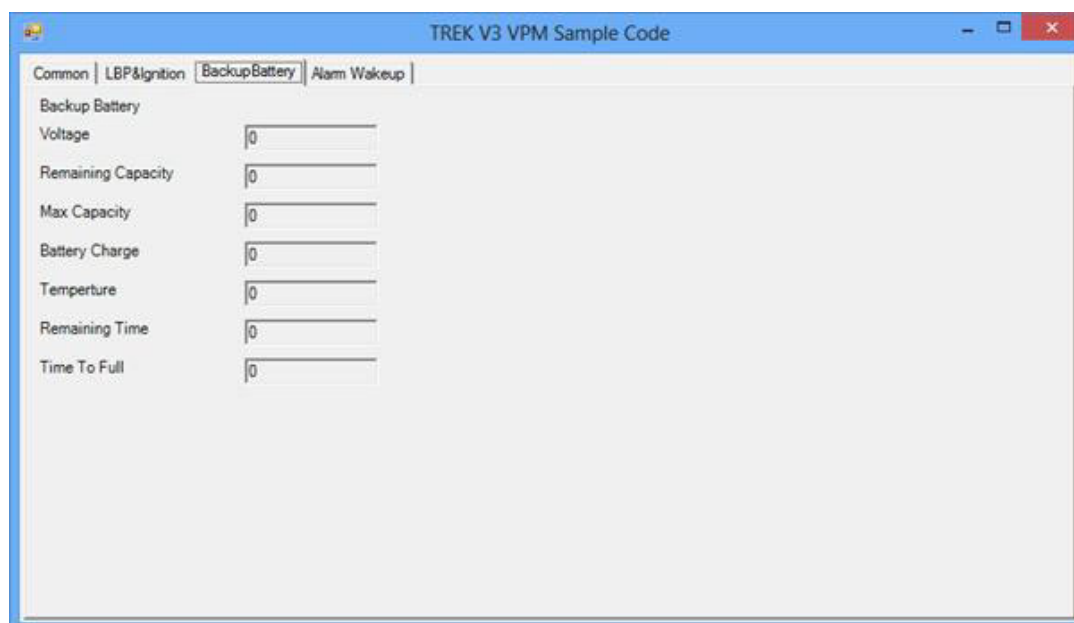

## Alarm Wakeup Control page

- VPM Common page as below figure

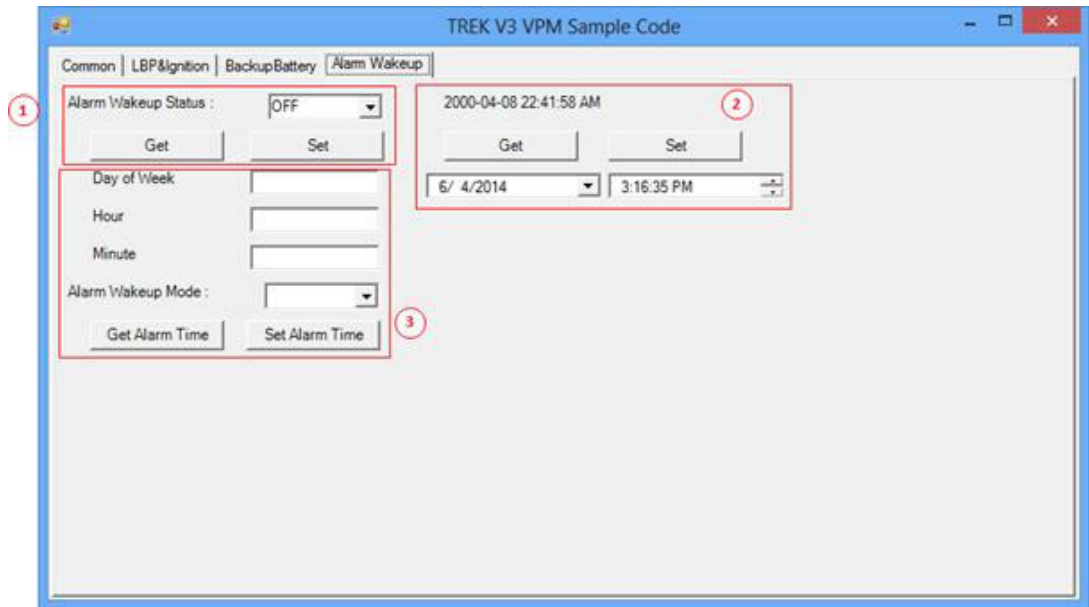

1. Alarm wakeup Status Control
2. RTC Timer Control
3. Alarm Wakeup Time Control

## Testing VPM

1. Opening "TREK\_V3\_Sample\_Code\_VPM.exe"
2. You should see the firmware version and voltage below figure

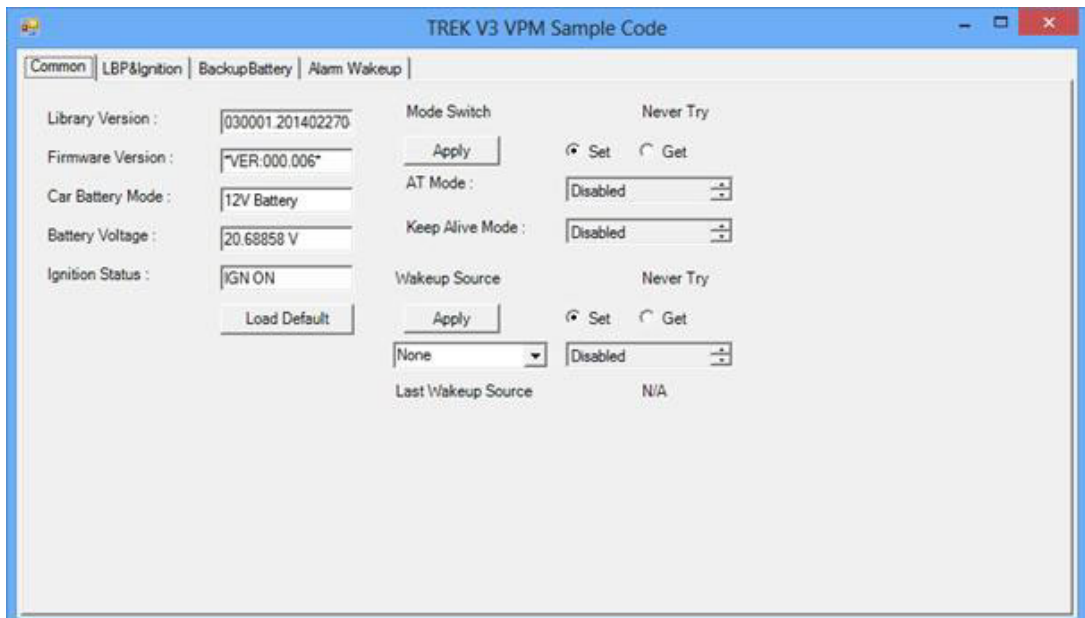

## 6.4 WatchDog Sample Code

TREK V3 Watch Dog Sample Code is demonstration of controlling Watch Dog.

### System Menu

- TREK V3 Watch Dog Sample Code as below figure

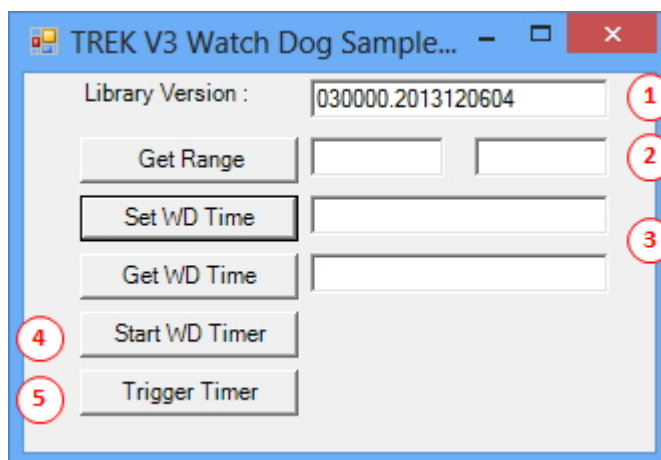

1. Library Version
2. Range of Watch Dog timer
3. Set/Get Watch Dog time
4. Enable Watch Dog timer
5. Reload the watchdog timer to prevent the system from rebooting

### Testing Watch Dog

1. Opening "TREK\_V3\_Sample\_Code\_Watch\_Dog.exe"
2. Press "Get Range" button to check the range of watch dog timer
3. Input the time which you want system keep alive. For example 1 minute as below figure

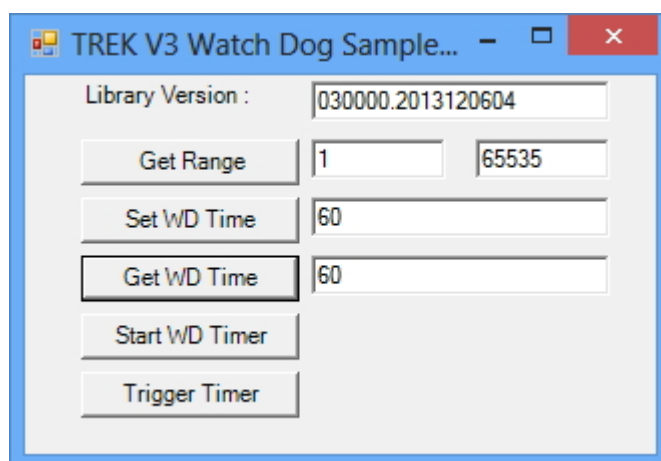

4. Press "Start WD Timer" to enable watch dog timer
5. Press "Trigger timer" to tell the watch dog system still alive

- If system not trigger watch dog in the setting time, you should see the system automotive reboot

**Caution!** This demonstration may reboot your system, if you enable watch dog timer and not trigger watch dog timer in time.



## 6.5 Peripheral Control Demo Program

TREK V3 Peripheral Control Sample Code is demonstration of controlling peripheral power.

### System Menu

- TREK V3 Peripheral Control Sample Code as below figure

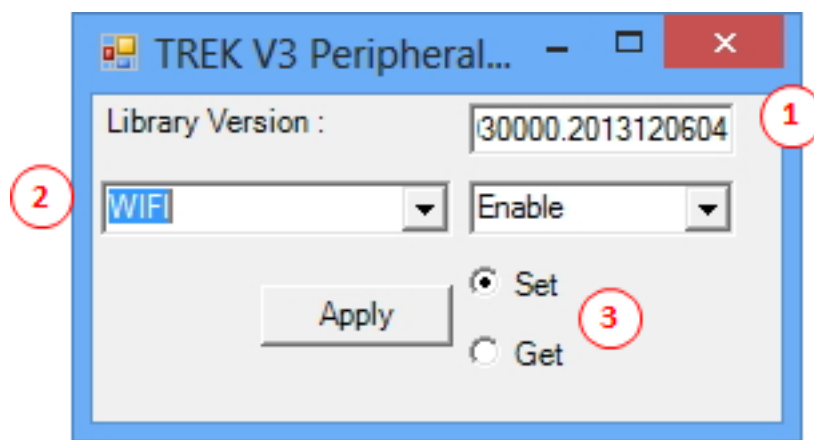

- Library Version
- Select Peripheral
- Select Set or Get function

### Testing Peripheral Control

Getting Peripheral Power Status

- Opening "TREK\_V3\_Sample\_Code\_PeripheralCtrl.exe"
- Selecting module, For example "WIFI".
- Selecting "Get" radio button
- Press "Apply" button
- You should see the peripheral power status as below figure

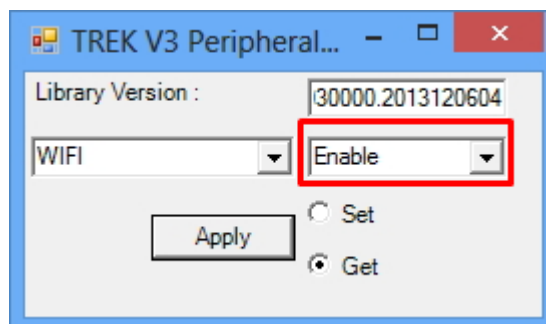

For example. Selecting WIFI module. I can see the WIFI module is enable.

#### Opening Peripheral Power

If you want close the specified peripheral power, following the instruction:

1. Opening "TREK\_V3\_Sample\_Code\_PeripheralCtrl.exe"
2. Selecting module, For example "WIFI"
3. Selecting "Set" radio button
4. Press "Enable/Disable" combo box and selecting "Enable"
5. Press "Apply" button
6. You should see the peripheral power is on

**Note!** System need a little time to enable peripheral.



#### Closing Peripheral Power

If you want close the specified peripheral power, following the instruction:

1. Opening "TREK\_V3\_Sample\_Code\_PeripheralCtrl.exe"
2. Selecting module, For example "WIFI"
3. Selecting "Set" radio button
4. Press "Enable/Disable" combo box and selecting "Disable"
5. Press "Apply" button
6. You should see the peripheral power is closed





# Appendix **A**

## TREK-303

This appendix explains the TREK-303 detailed information.

## A.1 Paired with TREK-303 Specifications

**Table A.1: TREK-303 Specification**

	Models	TREK-303R-LA0E	TREK-303R-HA0E
Display	Design compatible models	Paired with TREK-510	Paired with TREK-550 A2
	Resolution (pixel)	480 x 234	800 x 480
	Number of colors	262 K (supports 18-bit)	262 K (supports 24-bit)
	Pixel pitch	0.107(W) x 0.37 (H)	0.2168(H) x 0.2168 (V)
	Brightness (cd/m2)	500 (typical) without touchscreen	500 (typical) without touchscreen
	View angle (R/L/B/T)	70°/70°/60°/60°	70°/70°/60°/60°
	Contrast ratio	300	500
	Lamp life (hrs)	10,000 (min)	50,000 (min) Lamp type
	Lamp type	CCFL	LED
	Touch-screen	Touchscreen	4-wire resistive (GFG 4-wire design reserve)
Front plane	Speaker	2 watts	
	Hotkey	Supports 5 hotkeys (user defined)	
	Brightness control	Light sensing (default), manually controlled by button (optional)	
	USB host	x 1	
Backplane	Power/wake up button	Yes	
	Reset button	Yes	
Power	DC input	12 V ± 5%	
	Power Consumption	~ 8 W (Max.)	
Mechanical	Mounting	Design compatible with RAM mount Material	
	Weight	1 kg	
	Dimensions	244 x 160 x 41 mm	
	IP rating	IP54 (without I/O connector)	
Environment	Operating temperature	-30 ~ +70° C	
	Storage temperature	-40 ~ +80° C	
	Vibration	MIL-STD-810F, SAE J1455 4.9. 4.2	

**Note!**



1. *The Brightness control is adjusted by the auto light sensor in the front panel as default; it is also defined by button on the front panel by manual.*
2. *The color LCD display*



- A. USB Host
- B. 5 programmable hotkeys
- C. D. Brightness control
- E. Power LED
- F. Light sensor
- G. Speaker

**Note: Backlight off: Press C button to the lowest level**



Power button LVDS connector

**Pin out for TREK-303 LVDS connector**

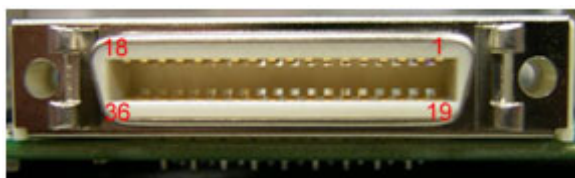

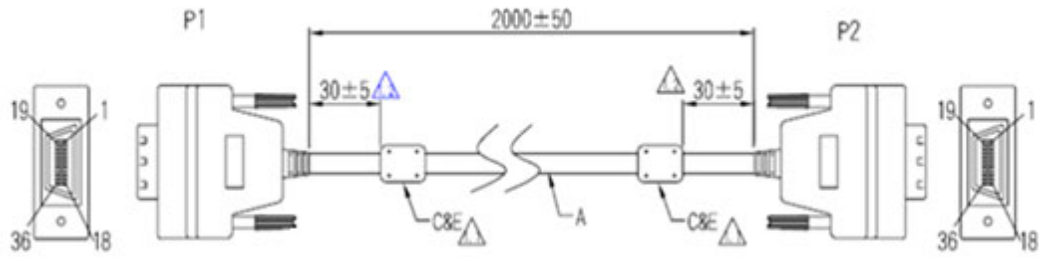

### Pin assignment

P1	1	2	3	4	5	6	7	8	9	10	11	12	13	14	15	16	17	18
P2	1	2	3	4	5	6	7	8	9	10	11	12	13	14	15	16	17	18
Color		White	Ground		red	white	Ground	Ground		white	red		yellow	white	Ground	Ground	Green	white



19	20	21	22	23	24	25	26	27	28	29	30	31	32	33	34	35	36
19	20	21	22	23	24	25	26	27	28	29	30	31	32	33	34	35	36
	white	Ground	yellow			Purple	Grey	white	Black	Black Brown	black red	Orange	Black Yellow	Black green	Black blue	Black purple	Black grey



### TREK-303 Hotkey Utility

Execute IMC demo utility



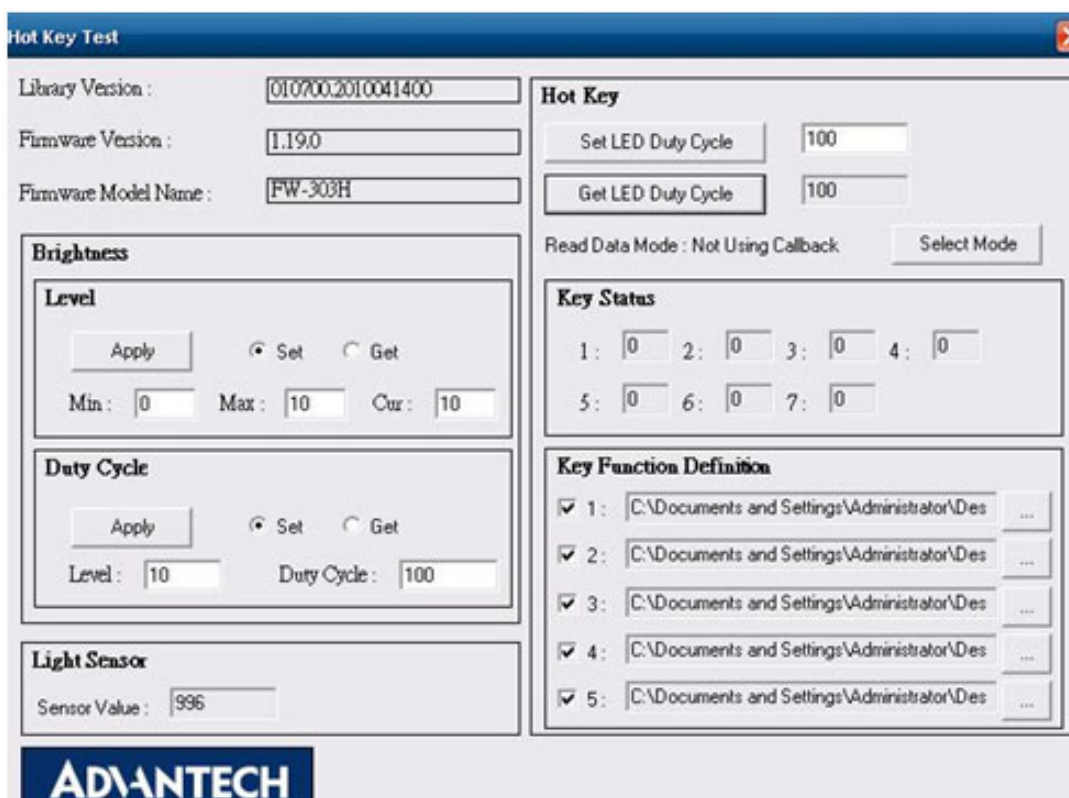

Figure A.1 Hotkey utility

1. Execute “Hot Key test” program →
2. Brightness level: You may set panel’s brightness from level 0 ~10, total 10 levels, when you finish setting the brightness level you want, please click “Apply”. If you want to check the current brightness level of TREK-303, please click “Get”.
3. Duty cycle: You may set every level’s brightness strength, total 10 levels, when you finish setting the brightness strength for each level, please click “Apply”. If you want to check the current brightness strength on certain level of TREK-303, please click “Get”.
4. Light sensor: When the sensor has detected the change of the brightness in the environment, the value will change. The lowest level of brightness, the lowest value it is presented. On the contrary, the highest level of brightness, the highest value it is presented.
5. Hotkey: the backlight brightness of hotkeys could be adjusted by setting the value from 0 ~100.
6. Key Status: When you press Hot key, the status will change from 0 to 1.
7. Key function Definition: You may set the parameter to connect the application program of the hot key.

## [www.advantech.com](http://www.advantech.com)

Please verify specifications before quoting. This guide is intended for reference purposes only.

All product specifications are subject to change without notice.

No part of this publication may be reproduced in any form or by any means, electronic, photocopying, recording or otherwise, without prior written permission of the publisher.

All brand and product names are trademarks or registered trademarks of their respective companies.

© Advantech Co., Ltd. 2015

