

Chip Beads(SMD Array) For General Signal Line

Conformity to RoHS Directive

MZA Series MZA3216 Type

FEATURES

- A single MZA series chip provides noise attenuation for four lines, making it ideal for use with I/O lines of various highly miniaturized.
- Electronic equipment, such as portable products, which comprise high density circuitry.
- Low crosstalk between adjacent circuits.
- Internal electrodes feature low DC resistance, minimizing wasteful power consumption.
- Electroplated terminal electrodes accommodate reflow soldering.
- Monolithic structure ensures high reliability.
- The products contain no lead and also support lead-free soldering.
- It is a product conforming to RoHS directive.

APPLICATIONS

High-frequency noise countermeasure in computers, printers, VCRs, televisions, portable telephones, and other equipment.

PRODUCT IDENTIFICATION

MZA 3216 R 121 A T
(1) (2) (3) (4) (5) (6)

- (1) Series name
 (2) Dimensions L×W
 (3) Material code
 (4) Nominal impedance
 121:120Ω at 100MHz
 (5) Characteristic type
 (6) Packaging style
 T:Taping

RECOMMENDED SOLDERING CONDITION

REFLOW SOLDERING

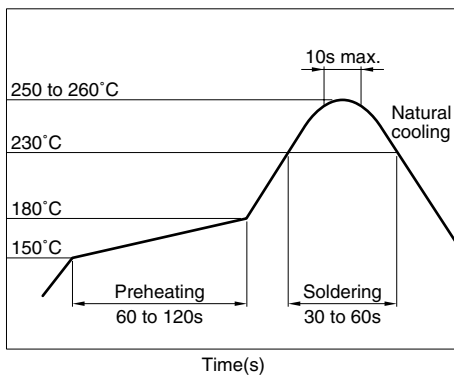

SHAPES AND DIMENSIONS/RECOMMENDED PC BOARD PATTERN (REFLOW SOLDERING)

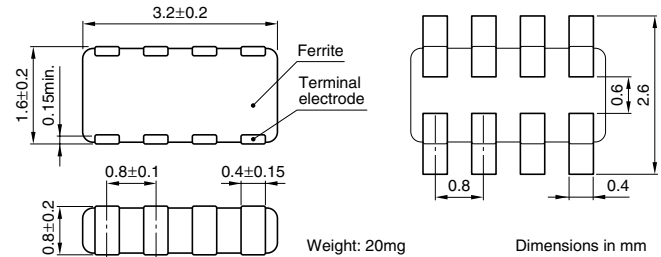

TEMPERATURE RANGES

Operating/storage	-55 to +125°C
-------------------	---------------



PACKAGING STYLE AND QUANTITIES

Packaging style	Quantity
Taping	4000 pieces/reel

HANDLING AND PRECAUTIONS

- Before soldering, be sure to preheat components. The preheating temperature should be set so that the temperature difference between the solder temperature and product temperature does not exceed 150°C.
- After mounting components onto the printed circuit board, do not apply stress through board bending or mishandling.
- Do not expose the inductors to stray magnetic fields.
- Avoid static electricity discharge during handling.
- When hand soldering, apply the soldering iron to the printed circuit board only. Temperature of the iron tip should not exceed 350°C. Soldering time should not exceed 3 seconds.
- This product does not apply to flow soldering construction method.

• Conformity to RoHS Directive: This means that, in conformity with EU Directive 2002/95/EC, lead, cadmium, mercury, hexavalent chromium, and specific bromine-based flame retardants, PBB and PBDE, have not been used, except for exempted applications.

• Please contact our Sales office when your application are considered the following:
 The device's failure or malfunction may directly endanger human life (e.g. application for automobile/aircraft/medical/nuclear power devices, etc.)

• All specifications are subject to change without notice.

ELECTRICAL CHARACTERISTICS

Part No.	Impedance(Ω) $\pm 25\%$ [100MHz]*	DC resistance (Ω)max.	Rated current (mA)max.	Rated voltage (V)max.
MZA3216R121A	120	0.18	250	5
MZA3216R301A	300	0.4	200	5
MZA3216R601A	600	0.45	200	5
MZA3216R102A	1000	0.6	150	5
MZA3216S600A	60	0.2	300	5
MZA3216S121A	120	0.2	250	5
MZA3216S301A	300	0.4	200	5
MZA3216S601A	600	0.5	200	5
MZA3216Y600B	60	0.2	300	5
MZA3216Y121B	120	0.2	250	5
MZA3216Y241B	240	0.3	200	5
MZA3216Y601B	600	0.5	200	5
MZA3216Y102B	1000	0.6	150	5
MZA3216D121C	120	0.45	200	5
MZA3216D241C	240	0.6	150	5
MZA3216D301C	300	0.8	100	5

* Test equipment: E4991A or equivalent
 Test tool: 16192A or equivalent
 Test temperature: 25 \pm 10°C

TYPICAL ELECTRICAL CHARACTERISTICS

Z, X, R vs. FREQUENCY CHARACTERISTICS

MZA3216R121A

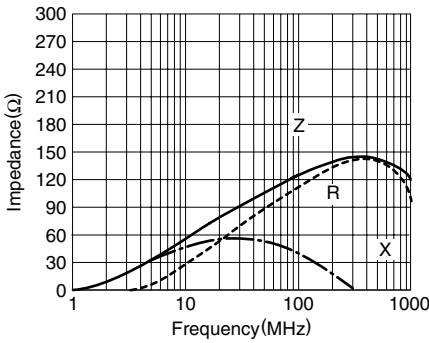

MZA3216R301A

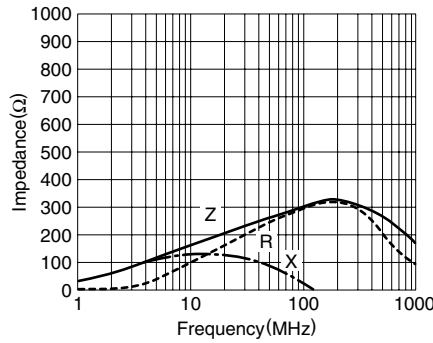

MZA3216R601A

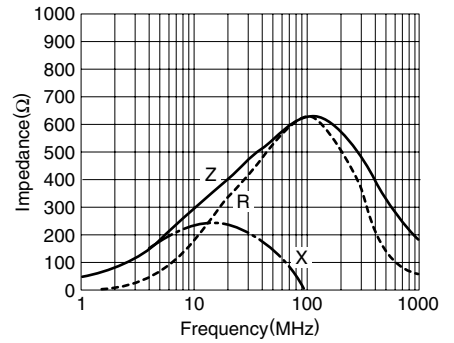

MZA3216R102A

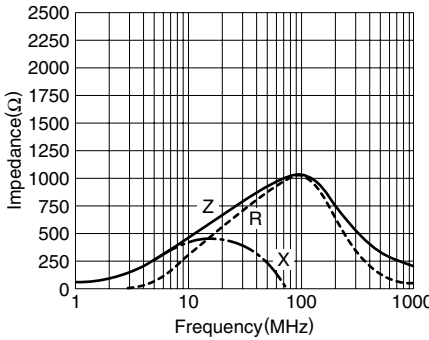

MZA3216S600A

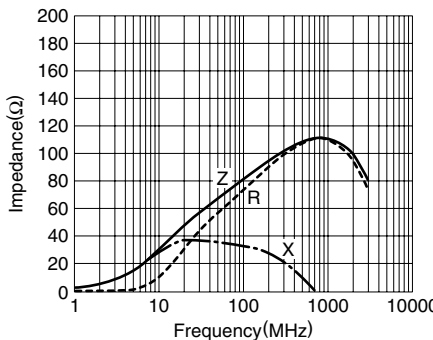

MZA3216S121A

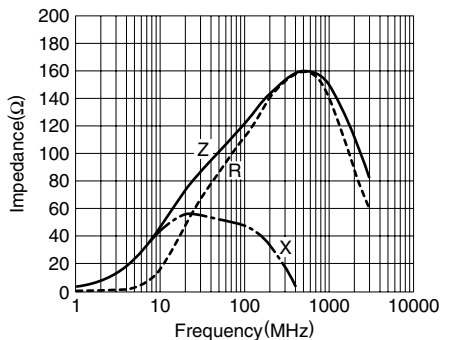

MZA3216S301A

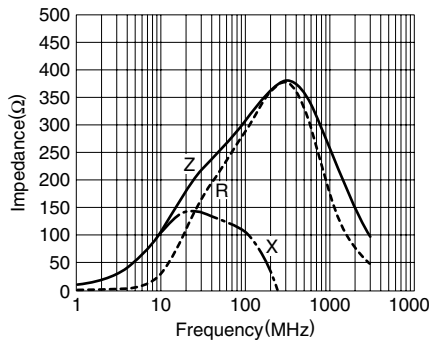

MZA3216S601A

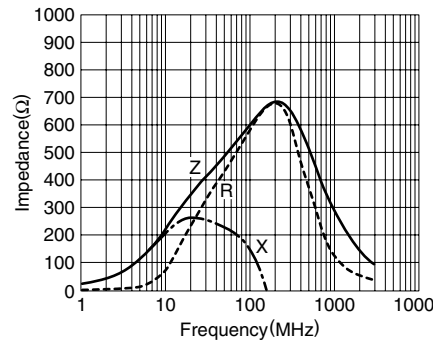

MZA3216Y600B

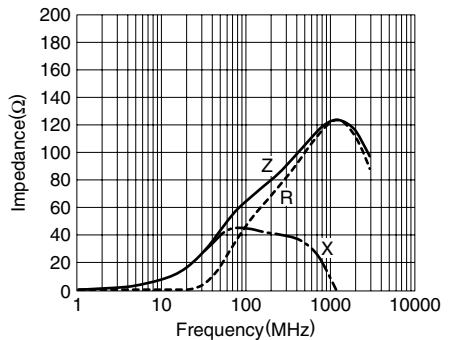

• All specifications are subject to change without notice.

TYPICAL ELECTRICAL CHARACTERISTICS

Z, X, R vs. FREQUENCY CHARACTERISTICS

MZA3216Y121B

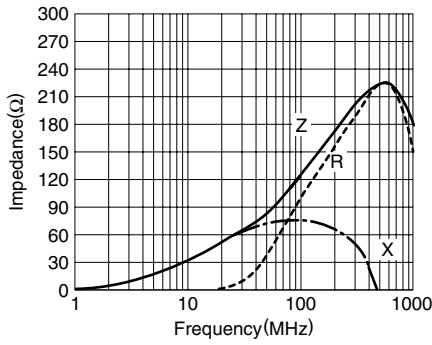

MZA3216Y241B

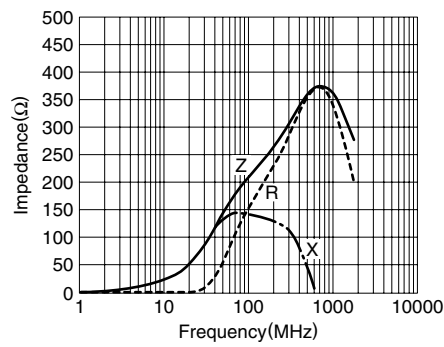

MZA3216Y601B

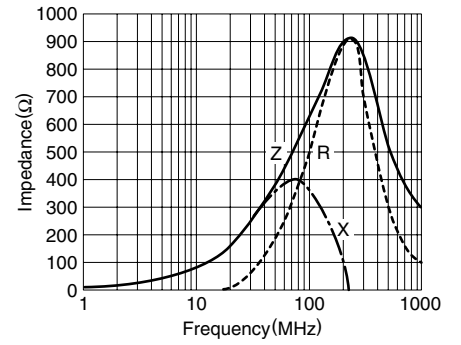

MZA3216Y102B

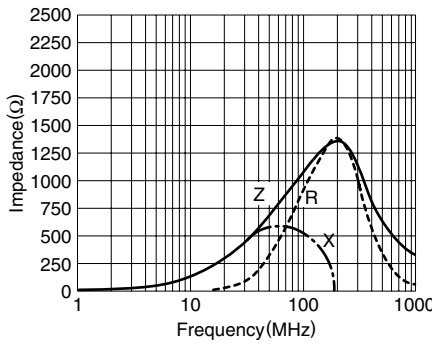

MZA3216D121C

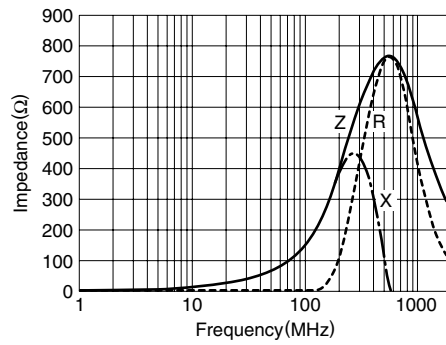

MZA3216D241C

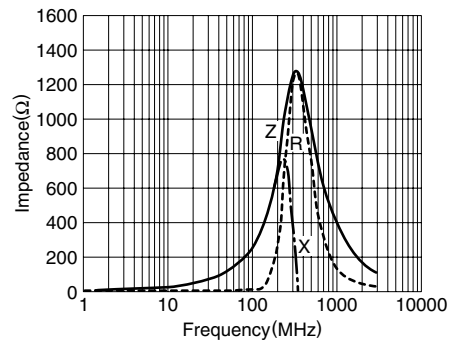

MZA3216D301C

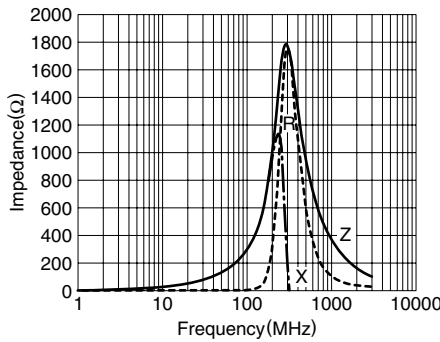

PACKAGING STYLES

REEL DIMENSIONS

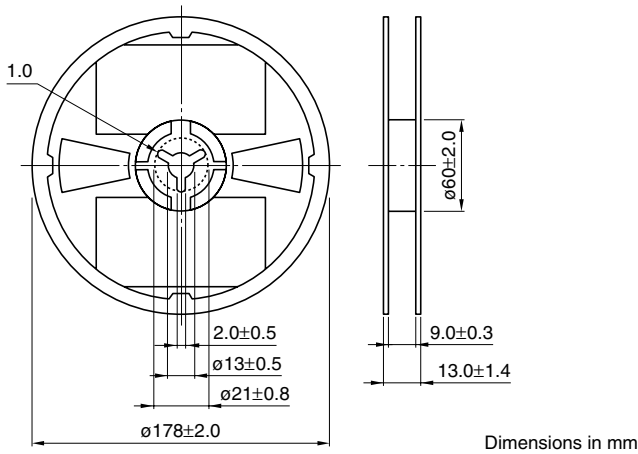

TAPE DIMENSIONS

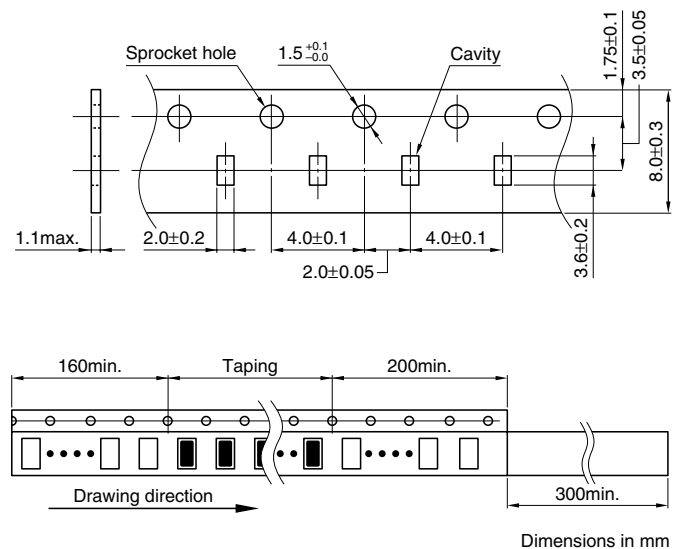

• All specifications are subject to change without notice.