

60V, 3A Silent Switcher Synchronous, Step-Up LED Driver

FEATURES

- 2% LED Current Regulation
- 2.5% Output Voltage Regulation
- 50,000:1 PWM Dimming at 100Hz
- 512:1 Internal PWM Dimming
- Spread Spectrum Frequency Modulation
- Silent Switcher Architecture for Ultralow EMI
- Operates in Boost, Buck Mode and Buck-Boost Mode
- 4V to 56V Input Voltage Range
- Up to 52V LED String Voltage
- Adaptive Peak Switch Current Limit Up to 5A for Low V_{IN}
- 200kHz to 2MHz with SYNC Function
- Analog or Duty Cycle LED Current Control
- Open/Short LED Protection and Fault Indication
- Small 28-Lead 4mm × 5mm LQFN Package
- AEC-Q100 Qualified for Automotive Applications

APPLICATIONS

- Automotive and Industrial Lighting
- Heads Up Display (HUD)/Machine Vision

DESCRIPTION

The **LT[®]8386** is a monolithic, synchronous, step-up DC-to-DC converter that utilizes fixed frequency, peak current control and provides PWM dimming for a string of LEDs. The LED current is programmed by an analog voltage or digital pulses at the CTRL pin. The LT8386 will maintain 2% current regulation through an external sense resistor over a wide range of output voltages.

The LT8386 features Silent Switcher[®] technology designed to minimize EMI/EMC emissions with high efficiency. The switching frequency is programmable from 200kHz to 2MHz by an external resistor at the RT pin or by an external clock applied at the SYNC/SPRD pin. With the optional spread spectrum frequency modulation enabled, the frequency varies from 100% to 125% to reduce EMI.

The LT8386 includes a driver for an external high side PMOS for PWM dimming. The 60V rated LT8386 is pin-to-pin compatible with the LT3922 and LT3922-1.

All registered trademarks and trademarks are the property of their respective owners. Protected by U.S. patents, including 10291128, 10136488, 9642200.

TYPICAL APPLICATION

2MHz, 90% Efficient 14W (47V, 300mA) Boost LED Driver

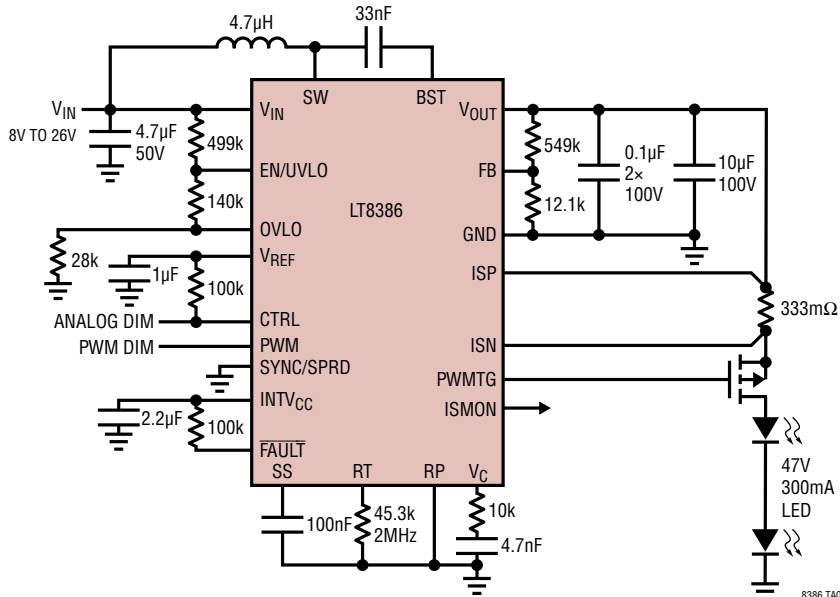

Efficiency vs V_{IN}

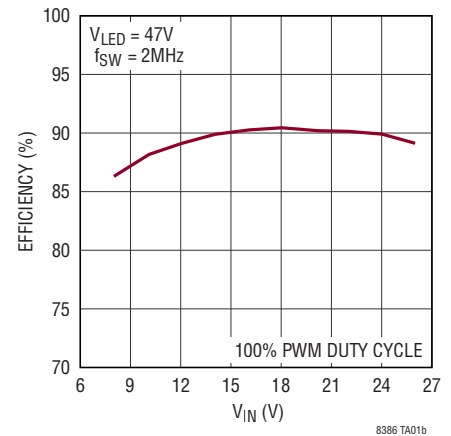

ABSOLUTE MAXIMUM RATINGS

(Note 1)

V_{IN} and EN/UVLO	-0.3V to 60V
ISP, ISN, and V_{OUT}	-0.3V to 60V
ISP – ISN	-1V to 1V
FB, SS, and V_C	-0.3V to 3.6V
CTRL, OVLO, PWM, SYNC/SPRD, and \overline{FAULT} ...	-0.3V to 5V
SW, BST, INTV _{CC} , V_{REF} , ISMON, PWMTG, RT, and RP	(Note 2)

Operating Junction Temperature Range (Notes 3, 4)

LT8386E	-40°C to 125°C
LT8386J	-40°C to 150°C
Storage Temperature Range	-65°C to 150°C
Maximum Reflow (Package Body) Temperature	260°C

PIN CONFIGURATION

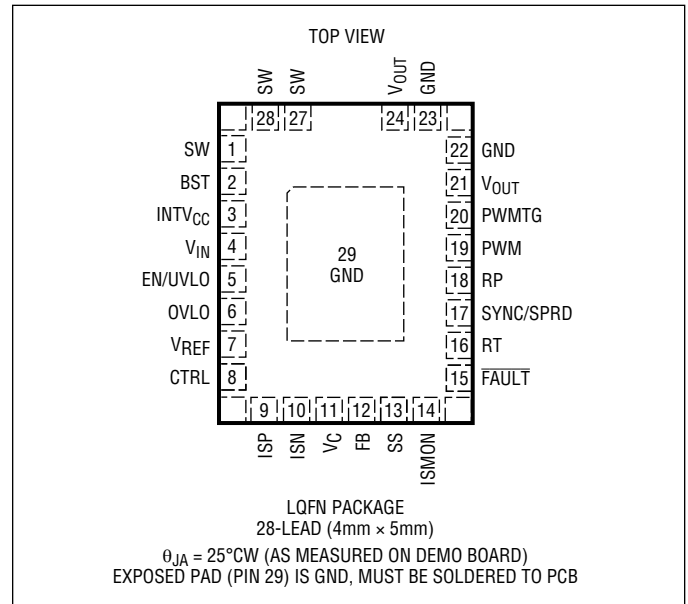

ORDER INFORMATION

PART NUMBER	PART MARKING*	FINISH CODE	PAD FINISH	PACKAGE TYPE**	MSL RATING	TEMPERATURE RANGE
LT8386EV#PBF	8386	e4	Au (RoHS)	LQFN (Laminate Package with QFN Footprint)	3	-40°C to 125°C
LT8386JV#PBF						-40°C to 150°C

AUTOMOTIVE PRODUCTS**

LT8386EV#WPBF	8386	e4	Au (RoHS)	LQFN (Laminate Package with QFN Footprint)	3	-40°C to 125°C
LT8386JV#WPBF						-40°C to 150°C

• Contact the factory for parts specified with wider operating temperature ranges. *Device temperature grade is identified by a label on the shipping container. Pad or ball finish code is per IPC/JEDEC J-STD-609.

- [Recommended LGA and BGA PCB Assembly and Manufacturing Procedures](#)
- [LGA and BGA Package and Tray Drawings](#)

Parts ending with PBF are RoHS and WEEE compliant. **The LT8386 packages has the same footprint as a standard 4mm × 5mm QFN Package.

**Versions of this part are available with controlled manufacturing to support the quality and reliability requirements of automotive applications. These models are designated with a #W suffix. Only the automotive grade products shown are available for use in automotive applications. Contact your local Analog Devices account representative for specific product ordering information and to obtain the specific Automotive Reliability reports for these models.

ELECTRICAL CHARACTERISTICS

The ● denotes the specifications which apply over the full operating temperature range, otherwise specifications are at $T_A = 25^\circ\text{C}$, $V_{IN} = 12\text{V}$, $V_{EN/UVLO} = 2\text{V}$ unless otherwise noted.

PARAMETER	CONDITIONS	MIN	TYP	MAX	UNITS
Input Voltage Range		4		56	V
V_{IN} Pin Quiescent Current	$V_{EN/UVLO} = 1.5\text{V}$, Not Switching $V_{EN/UVLO} = 0.3\text{V}$, Shutdown		3.5	4.5 1.5	mA μA
EN/UVLO Threshold (Falling)		1.280	1.330	1.420	V

ELECTRICAL CHARACTERISTICS The ● denotes the specifications which apply over the full operating temperature range, otherwise specifications are at $T_A = 25^\circ\text{C}$, $V_{IN} = 12\text{V}$, $V_{EN/UVLO} = 2\text{V}$ unless otherwise noted.

PARAMETER	CONDITIONS		MIN	TYP	MAX	UNITS
EN/UVLO Rising Hysteresis				25		mV
EN/UVLO Pin Current	$V_{EN/UVLO} = 1.2\text{V}$			2		μA
OVLO Threshold (Rising)			1.145	1.205	1.265	V
OVLO Falling Hysteresis				50		mV
OVLO Pin Current	$V_{OVLO} = 1\text{V}$		-1		1	μA
Reference						
V_{REF} Voltage	$I_{VREF} = 0\mu\text{A}$ $I_{VREF} = 1\text{mA}$	●	1.970 1.975	2 2	2.030 2.010	V V
V_{REF} Pin Current Limit	$V_{REF} = 0\text{V}$, Current Out of Pin			2		mA
LED Current Regulation						
CTRL-Off Threshold (Falling)		●	190	210	230	mV
CTRL-Off Rising Hysteresis				15		mV
CTRL Pin Current	$V_{CTRL} = 2\text{V}$		-100		100	nA
Sense Voltage ($V_{ISP} - V_{ISN}$) (Analog Input)	$V_{CTRL} = 2\text{V}$ (100%), $V_{ISP} = 24\text{V}$ $V_{CTRL} = 0.75\text{V}$ (50%), $V_{ISP} = 24\text{V}$ $V_{CTRL} = 0.35\text{V}$ (10%), $V_{ISP} = 24\text{V}$ $V_{CTRL} = 0.30\text{V}$ (5%), $V_{ISP} = 24\text{V}$	●	98	100	102	mV
			48.5	50	51.5	mV
			9	10	11.5	mV
			4	5	6.5	mV
ISP Pin Current	$V_{ISP} = 24.1\text{V}$, $V_{ISN} = 24\text{V}$, $V_{CTRL} = 2\text{V}$			75		μA
ISN Pin Current	$V_{ISP} = 24.1\text{V}$, $V_{ISN} = 24\text{V}$, $V_{CTRL} = 2\text{V}$			75		μA
Current Error Amplifier Transconductance	$V_{ISP} = 24\text{V}$			140		$\mu\text{A/V}$
Duty Cycle Control of LED Current						
Sense Voltage ($V_{ISP} - V_{ISN}$) (Duty Cycle Input)	CTRL Duty = 75% (100%), $V_{ISP} = 24\text{V}$ CTRL Duty = 37.5% (50%), $V_{ISP} = 24\text{V}$ CTRL Duty = 17.5% (10%), $V_{ISP} = 24\text{V}$ CTRL Duty = 15.0% (5%), $V_{ISP} = 24\text{V}$		99	100	101	mV
			48.5	50	51.5	mV
			9	10	11	mV
			4	5	6	mV
Digital CTRL Input High (V_{IH})			1.6			V
Digital CTRL Input Low (V_{IL})					0.4	V
Digital CTRL Input Frequency Range			10		200	kHz
Voltage Regulation						
FB Regulation Voltage	$V_{CTRL} = 2\text{V}$	●	1.170	1.200	1.230	V
FB Pin Current	FB in Regulation		-100		100	nA
Voltage Error Amplifier Transconductance				1000		$\mu\text{A/V}$
INTV_{CC} Regulator						
INTV _{CC} Voltage			3.4	3.6	3.8	V
INTV _{CC} Pin Current Limit	$V_{INTVCC} = 0\text{V}$, Current Out of Pin			40		mA
Power Stage						
Peak Switch Current Limit	$V_{IN} = 9\text{V}$ $V_{IN} = 5\text{V}$		3.3	3.6	4.0	A
			4.0	5.0	5.5	A
Bottom Switch Minimum Off-Time			13	25	30	ns
Bottom Switch On-Resistance				80		$\text{m}\Omega$
Top Switch On-Resistance				130		$\text{m}\Omega$
Oscillator						
Programmed Switching Frequency (f_{SW})	$R_T = 45.3\text{k}$, SYNC/SPRD = 0V $R_T = 499\text{k}$, SYNC/SPRD = 0V	●	1900	2000	2100	kHz
		●	180	210	240	kHz

ELECTRICAL CHARACTERISTICS

The ● denotes the specifications which apply over the full operating temperature range, otherwise specifications are at $T_A = 25^\circ\text{C}$, $V_{IN} = 12\text{V}$, $V_{EN/UVLO} = 2\text{V}$ unless otherwise noted.

PARAMETER	CONDITIONS		MIN	TYP	MAX	UNITS
Maximum Spread Spectrum Ratio	SYNC/SPRD = 3V			125		%
RT Pin Current Limit	$V_{RT} = 0\text{V}$, Current Out of Pin			75		μA
SYNC/SPRD Input High (V_{IH})			1.6			V
SYNC/SPRD Input Low (V_{IL})					0.8	V
SYNC/SPRD Pin Current	$V_{SYNC/SPRD} = 5\text{V}$		-100		100	nA
Soft-Start						
SS Pin Charging Current	$V_{SS} = 1\text{V}$			22		μA
SS Pin Discharging Current	$V_{SS} = 2\text{V}$			2		μA
SS Lower Threshold				0.2		V
SS Higher Threshold				1.55		V
Fault Detection						
Open-Circuit Threshold (FB Rising)		●	1.117	1.140	1.163	V
Open-Circuit Falling Hysteresis				50		mV
LED Short-Circuit Threshold ($V_{ISP} - V_{ISN}$)	$V_{ISP} = 20\text{V}$			150		mV
FAULT Pull-Down Current	$V_{FAULT} = 0.2\text{V}$, $V_{FB} = 1.25\text{V}$		0.8			mA
FAULT Leakage Current	$V_{FAULT} = 3.6\text{V}$, $V_{FB} = 0.7\text{V}$		-100		100	nA
Overvoltage Protection						
FB Overvoltage Threshold (Rising)		●	1.240	1.266	1.292	V
FB Overvoltage Falling Hysteresis				22		mV
LED Current Monitor						
ISMON Pin Voltage	$V_{ISP} - V_{ISN} = 100\text{mV}$ (100%), $V_{ISP} = 24\text{V}$ $V_{ISP} - V_{ISN} = 10\text{mV}$ (10%), $V_{ISP} = 24\text{V}$ $V_{ISP} - V_{ISN} = 5\text{mV}$ (5%), $V_{ISP} = 24\text{V}$		0.980	1.000	1.020	V
			80	100	120	mV
			30	50	70	mV
PWM Driver						
PWMTG Gate Drive ($V_{OUT} - V_{PWMTG}$)	$V_{OUT} = 20\text{V}$, $V_{PWM} = 2\text{V}$			10.5	12.5	V
PWM Input High (V_{IH})			1.7			V
PWM Input Low (V_{IL})					0.8	V
PWM Pin Current	$V_{PWM} = 2\text{V}$		-100		100	nA
PWM to PWMTG Propagation Delay	$C_{PWMTG} = 2.1\text{nF}$ (Connected from V_{OUT} to PWMTG) $V_{OUT} = 20\text{V}$	Turn-On		100		ns
		Turn-Off		140		ns
Internal PWM Dimming						
Preset PWM Dimming Ratio 1	$R_P = 332\text{k}$, $V_{REF} = 2\text{V}$, $V_{PWM}: 0.25\text{V to }0.35\text{V}$	●	1.0	1.1	1.2	%
Preset PWM Dimming Ratio 2	$R_P = 332\text{k}$, $V_{REF} = 2\text{V}$, $V_{PWM}: 0.47\text{V to }0.55\text{V}$	●	4.9	5	5.1	%
Preset PWM Dimming Ratio 3	$R_P = 332\text{k}$, $V_{REF} = 2\text{V}$, $V_{PWM}: 0.65\text{V to }0.75\text{V}$	●	9.8	9.9	10	%
PWM Voltage for 100% PWM Dimming	$R_P = 332\text{k}$, $V_{REF} = 2\text{V}$		2.00			V
PWM Voltage for 0% PWM Dimming	$R_P = 332\text{k}$, $V_{REF} = 2\text{V}$		0.86		0.98	V
			0		0.14	V
PWM Dimming Accuracy	$R_P = 332\text{k}$, $V_{REF} = 2\text{V}$, $V_{PWM} = 1.1\text{V}$ $R_P = 332\text{k}$, $V_{REF} = 2\text{V}$, $V_{PWM} = 1.9\text{V}$		8	10	12	%
			88.5	90	91.5	%
PWM Dimming Frequency	$R_P = 76.8\text{k}$, $R_T = 45.3\text{k}$, SYNC/SPRD = 0V $R_P = 332\text{k}$, $R_T = 45.3\text{k}$, SYNC/SPRD = 0V		1.80	1.95	2.10	kHz
			110	125	135	Hz
RP Pin Current Limit	$V_{RP} = 0\text{V}$, Current Out of Pin			70		μA

ELECTRICAL CHARACTERISTICS

Note 1: Stresses beyond those listed under Absolute Maximum Ratings may cause permanent damage to the device. Exposure to any Absolute Maximum Rating condition for extended periods may affect device reliability and lifetime.

Note 2: Do not apply a positive or negative voltage source to these pins, otherwise permanent damage may occur.

Note 3: The LT8386E is guaranteed to meet performance specifications from 0°C to 125°C junction temperature. Specifications over the -40°C to 125°C operating junction temperature range are assured by design,

characterization and correlation with statistical process controls. The LT8386J specifications over the -40°C to 150°C operating junction temperature range are assured by design, characterization and correlation with statistical process controls.

Note 4: This IC includes overtemperature protection that is intended to protect the device during momentary overload conditions. The maximum rated junction temperature will be exceeded when this protection is active. Continuous operation above the specified absolute maximum operating junction temperature may impair device reliability or permanently damage the device.

TYPICAL PERFORMANCE CHARACTERISTICS

$V_{IN} = 12V$, $T_A = 25^\circ C$ unless otherwise noted.

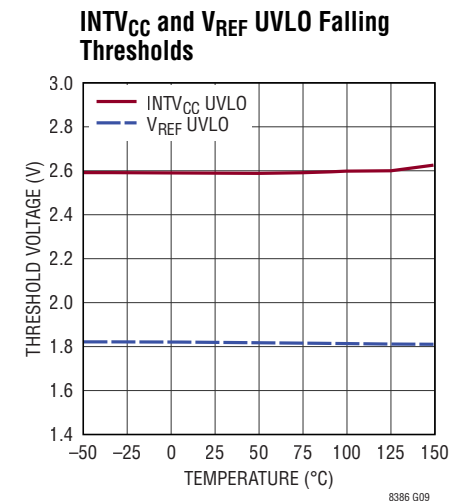
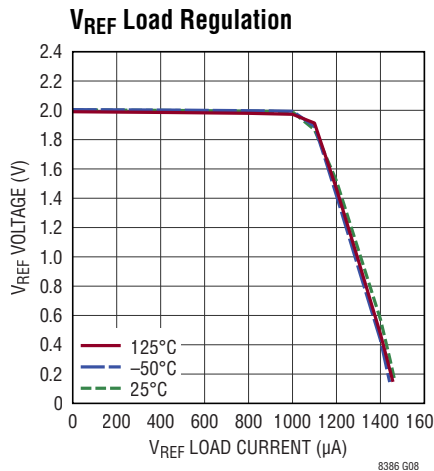
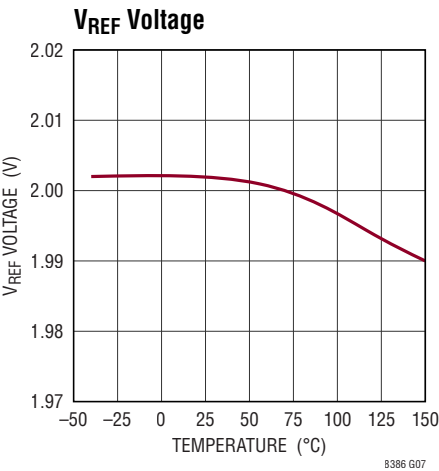
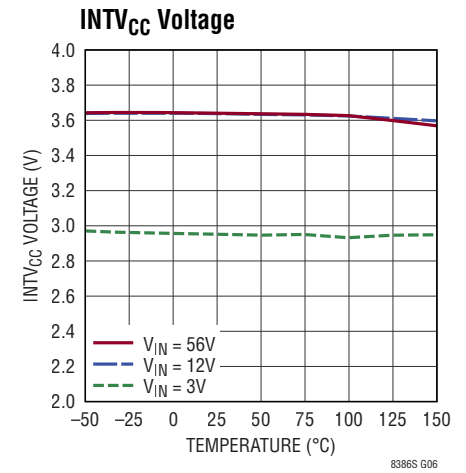
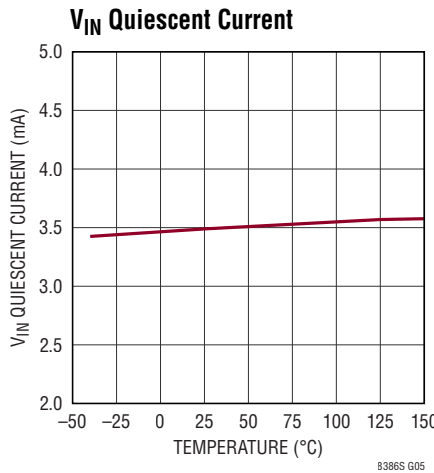
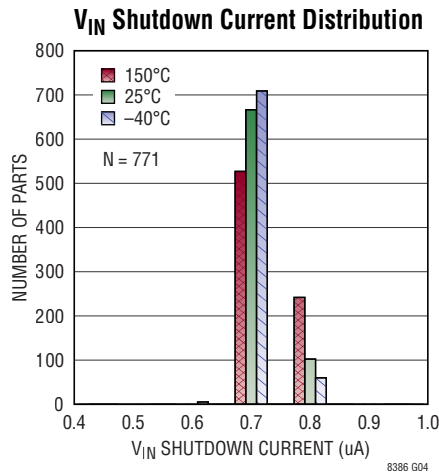
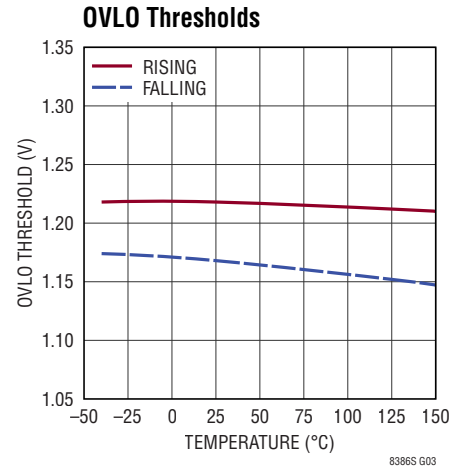
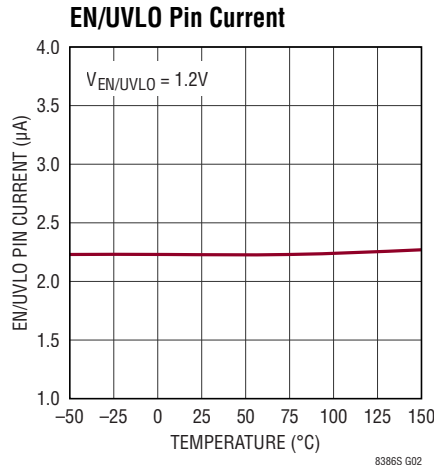
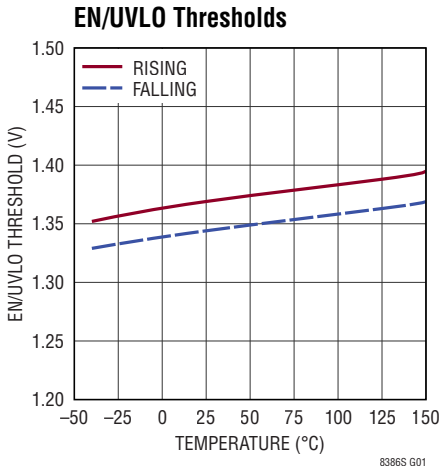

TYPICAL PERFORMANCE CHARACTERISTICS

$V_{IN} = 12V$, $T_A = 25^\circ C$ unless otherwise noted.

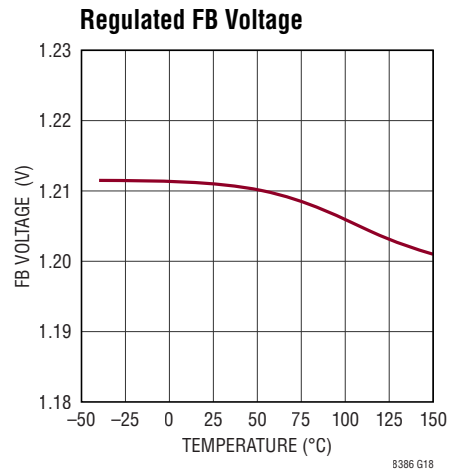
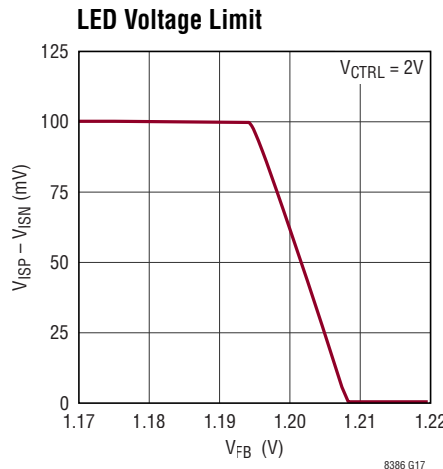
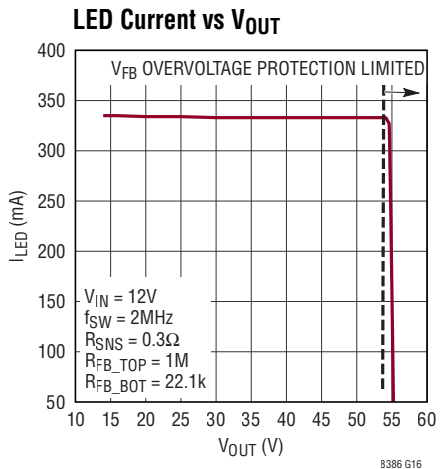
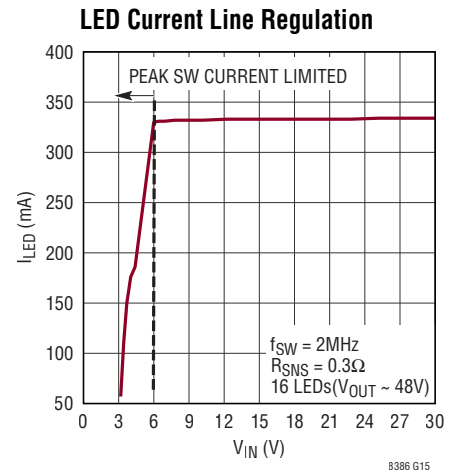
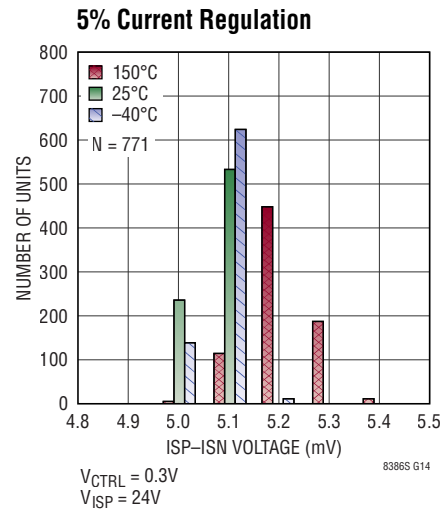
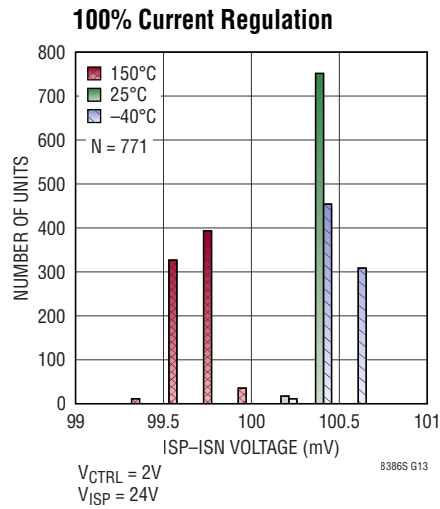
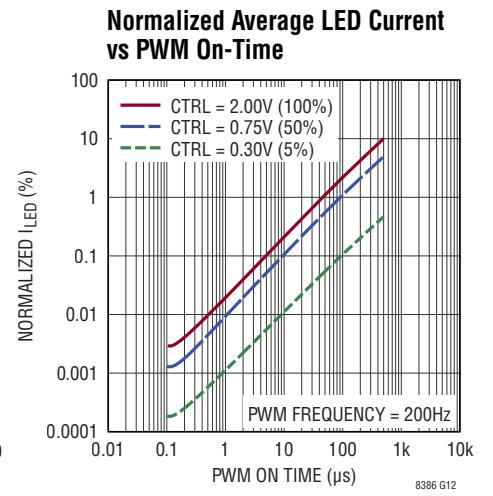
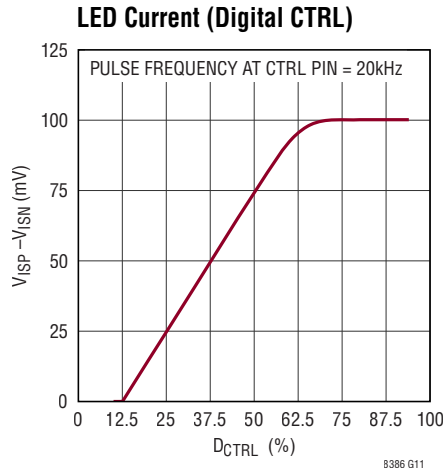
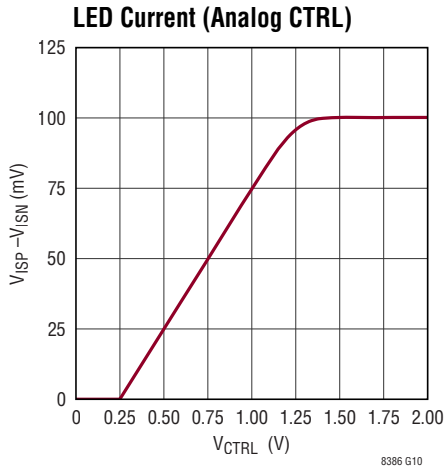

TYPICAL PERFORMANCE CHARACTERISTICS

$V_{IN} = 12V$, $T_A = 25^\circ C$ unless otherwise noted.

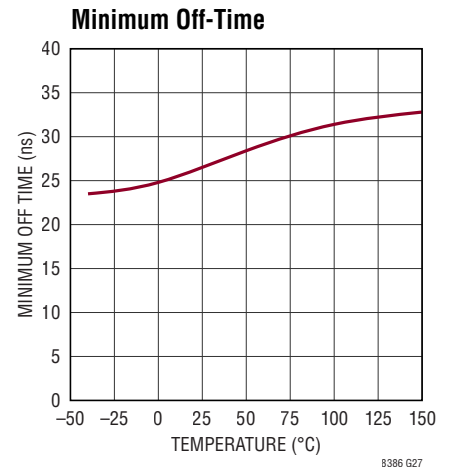
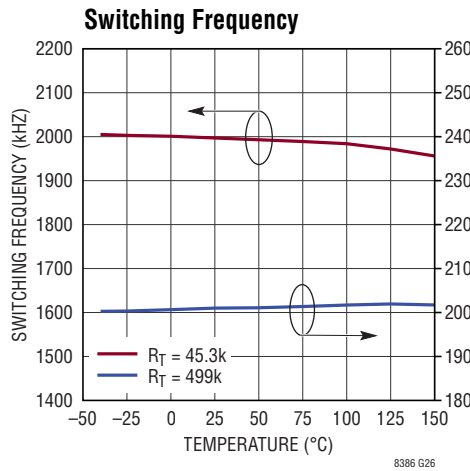
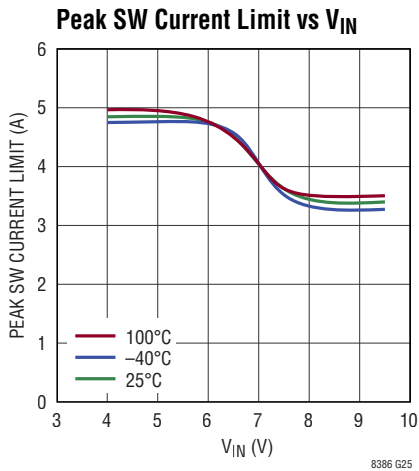
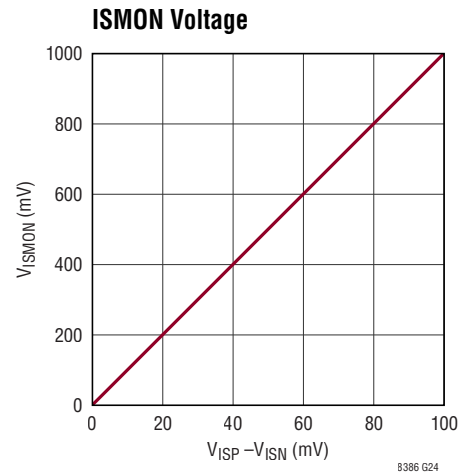
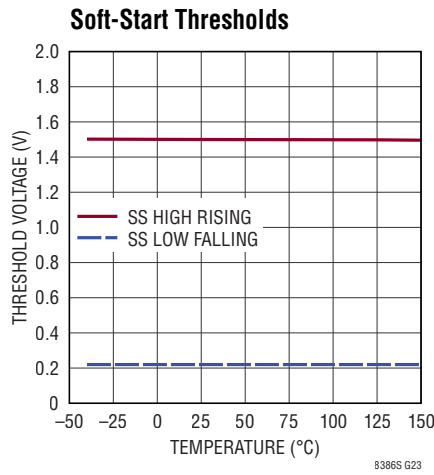
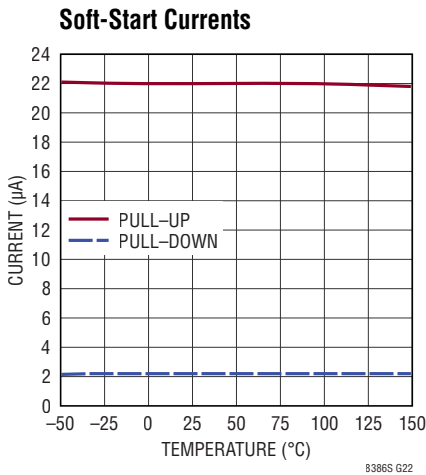
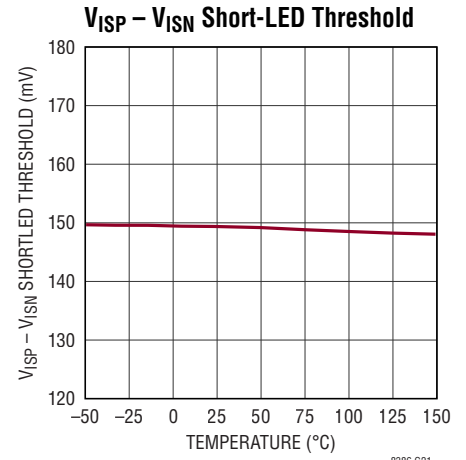
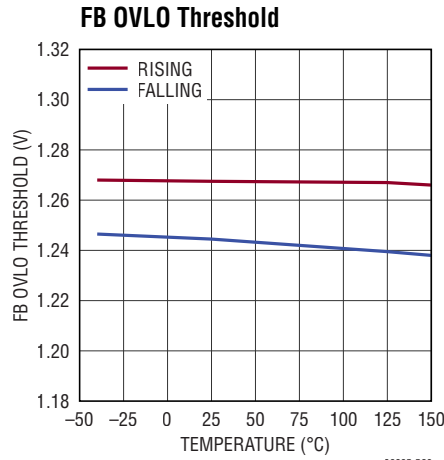
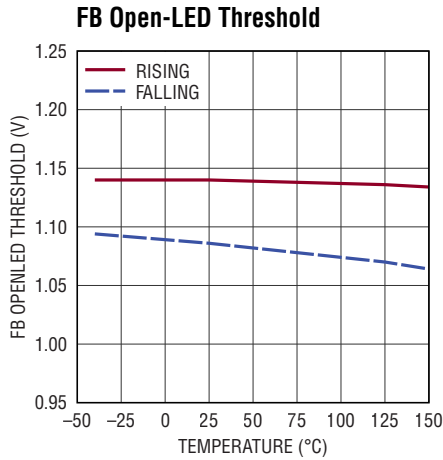

TYPICAL PERFORMANCE CHARACTERISTICS

$V_{IN} = 12V$, $T_A = 25^\circ C$ unless otherwise noted.

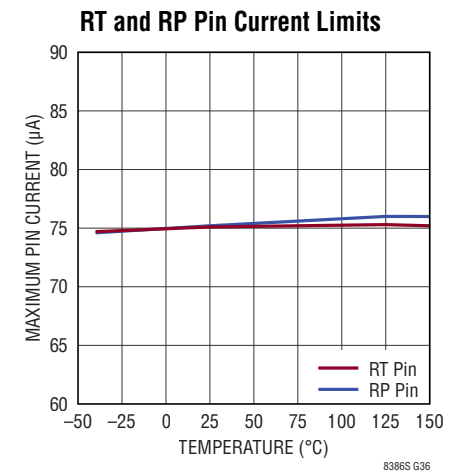
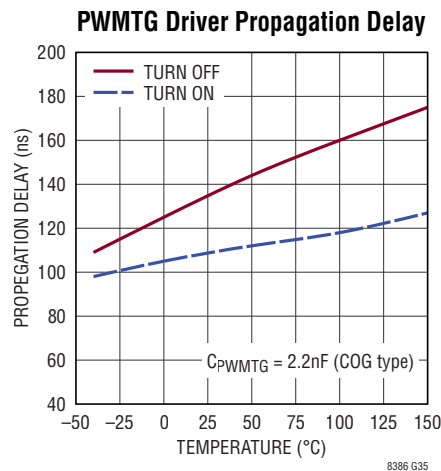
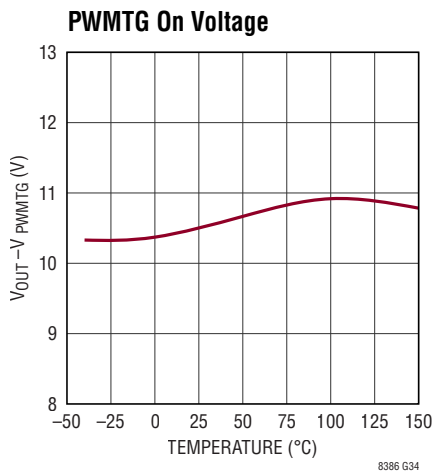
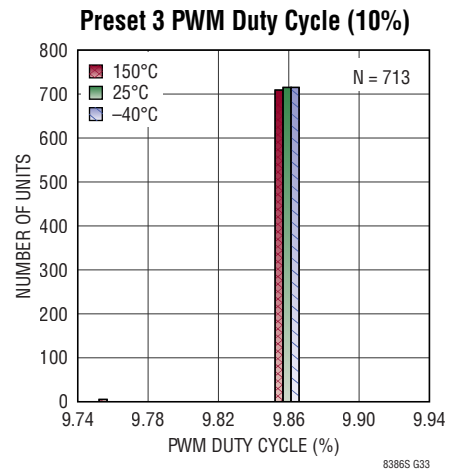
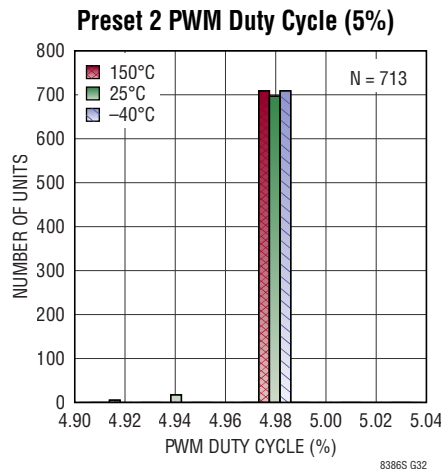
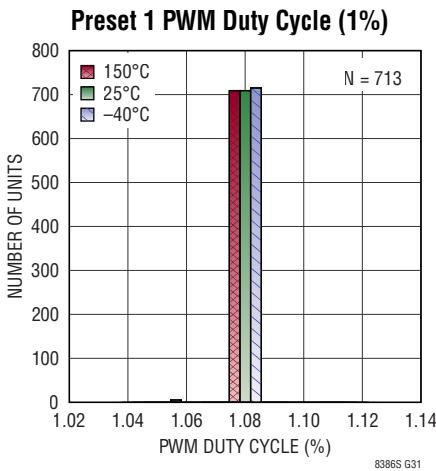
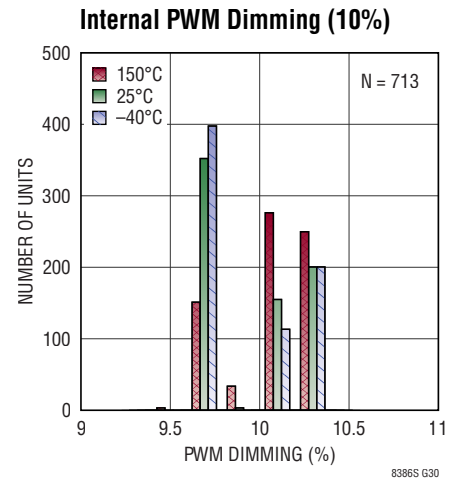
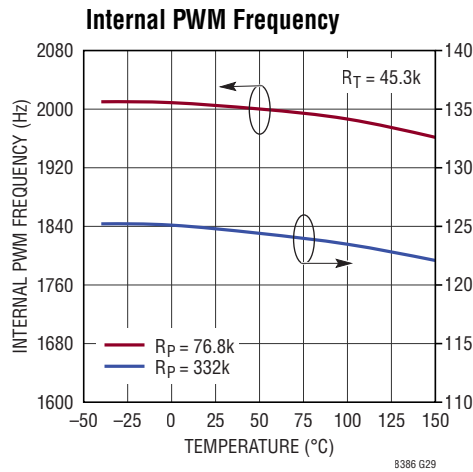
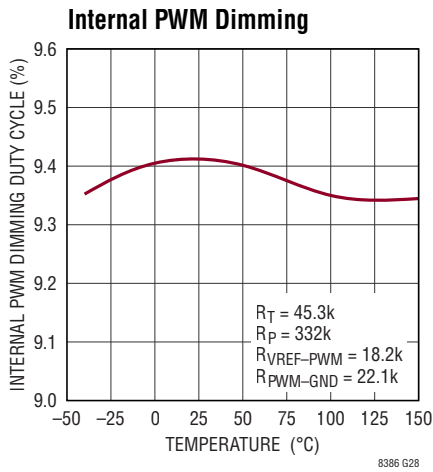

TYPICAL PERFORMANCE CHARACTERISTICS

$V_{IN} = 12V$, $T_A = 25^\circ C$ unless otherwise noted.

C/10 Threshold

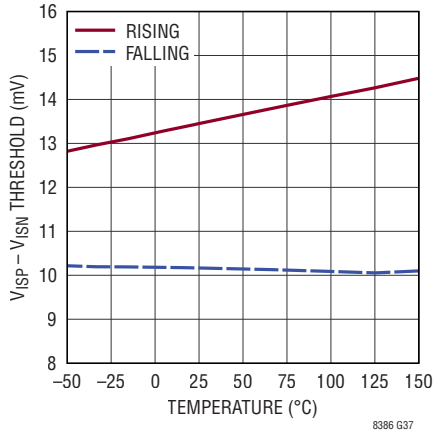

Case Temperature Rise

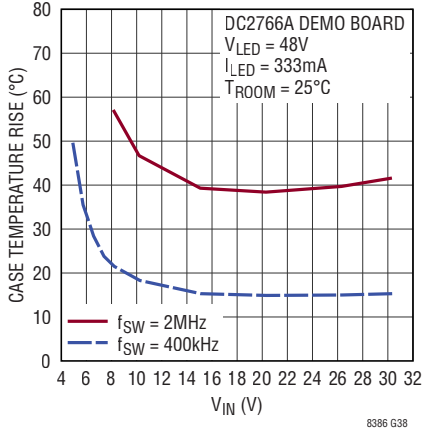

Power Switch On-Resistance

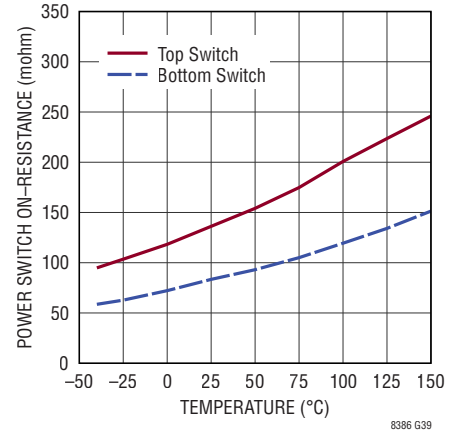

Efficiency vs V_{IN}

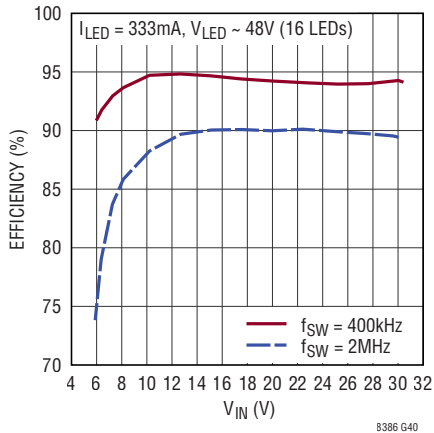

Efficiency vs I_{LED}

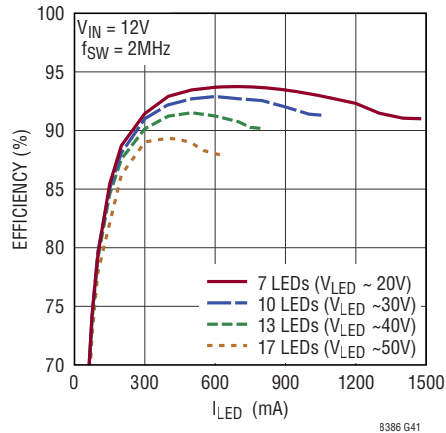

Input Voltage Transient Response

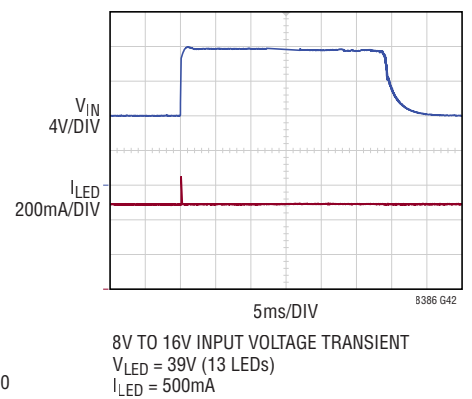

PIN FUNCTIONS

SW (Pins 1, 27, 28): Switch Pins. These pins are internally connected to the power devices and high-side gate driver. They should always be tied together. In normal operation, the voltage of these pins will switch between the output voltage and zero at the programmed frequency. Do not force any voltage on these pins.

BST (Pin 2): Boost Pin. This pin supplies the top power switch GATE driver. Connect a 33nF capacitor between this pin and the SW pin as close as possible to the package. An internal diode from $INTV_{CC}$ to BST will charge the capacitor when the SW pin switches low.

$INTV_{CC}$ (Pin 3): Internally Regulated, Low Voltage Supply Pin. This pin provides the power for the converter switch GATE drivers. Do not force any voltage on this pin. Place a 2.2 μ F bypass capacitor to GND close to the package.

V_{IN} (Pin 4): Input Voltage Pin. This pin supplies power to the internal, high performance analog circuitry. Connect a bypass capacitor between this pin and GND.

EN/UVLO (Pin 5): Enable and Undervoltage Lockout Pin. A voltage at this pin greater than 1.36V (typ.) will enable switching, and a voltage less than 0.1V is guaranteed to shutdown the internal current bias and sub regulators. A resistor network between this pin and ground can be used to set the pin voltage and automatically lockout the part when V_{IN} is below a certain level. No internal components pull up or down on this pin, so it requires an external voltage bias for normal operation. This pin may be tied directly to V_{IN} . For more details, see Applications Information section.

OVLO (Pin 6): Input Overvoltage Lockout Pin. When the voltage at this pin rises above 1.205V, the system disables switching and resets the soft-start capacitor. Do not leave this pin open. Tie this pin to GND when the OVLO function is not used. For more details, see Applications Information section.

V_{REF} (Pin 7): Reference Voltage Pin. This pin provides a buffered 2V reference. It can be used to supply resistor networks for setting the voltages at the CTRL and PWM pins. Bypass with a 0.1 μ F capacitor to GND.

CTRL (Pin 8): Control Pin. An analog voltage from 250mV to 1.25V at this pin programs the regulated voltage between ISP and ISN (and therefore, the regulated current supplied to the load). Depending on the applications, the CTRL pin can be affected by the noise in the system. A 10nF bypass capacitor at the CTRL pin can boost the noise immunity. Alternatively, a digital pulse at this pin with duty ratio from 12.5% to 62.5% can be used to program the regulated voltage. Below 200mV or 10% duty cycle, the CTRL pin voltage disables switching. For more detail, see Typical Performance Characteristics and Applications Information sections.

ISP (Pin 9): Positive Current Sense Pin. This pin is one of the inputs to the internal current sense error amplifier. It should be connected to the positive side of the external sense resistor. Use a Kelvin connection to the sense resistor for accurate current sensing.

ISN (Pin 10): Negative Current Sense Pin. This pin is one of the inputs to the internal current sense error amplifier. It should be connected to the negative side of the external sense resistor. Use a Kelvin connection to the sense resistor for accurate current sensing.

V_C (Pin 11): Compensation Pin. A resistor and capacitor connected in series from this pin to GND stabilize the current and voltage regulation. Typical resistor and capacitor values are from 0 to 100k Ω and from 10nF to 0.1nF, respectively.

FB (Pin 12): Feedback Pin. When the voltage at this pin is near 1.2V the regulated current is automatically reduced from the programmed value. A resistor network between this pin and V_{OUT} can be used to set a limit for the output voltage. If the voltage at the FB pin reaches 1.266V, a FB overvoltage lockout comparator disables switching.

SS (Pin 13): Soft-Start Pin. At start-up and recovery from fault conditions, a 22 μ A current charges the capacitor and the FB voltage tracks the rising voltage at this pin until the load current reaches its programmed level. Typical values for the capacitor are 10nF to 100nF. Using a single resistor from SS to $INTV_{CC}$, the LT8386 can be set in two different fault modes for the shorted LED conditions: hiccup (no resistor) and latchoff (<470k Ω). Refer to the Applications Information section for a detailed explanation.

PIN FUNCTIONS

ISMON (Pin 14): Output Current Monitoring Pin. This pin provides a buffered voltage output equal to 10mV for every 1mV between ISP and ISN.

FAULT (Pin 15): Fault Pin. Connect to INTV_{CC} through a resistance of 100k. An internal switch pulls this pin low when any of following conditions happen:

1. Open LED: $V_{FB} > 1.14V$ and $(V_{ISP} - V_{ISN}) < 10mV$
2. Shorted LED:
 $(V_{ISP} - V_{ISN}) > 150mV$ for more than 300 μs , or
 $(V_{ISP} - V_{ISN}) > 0.7V$

RT (Pin 16): Timing Resistor Pin. A resistor from this pin to GND programs the switching frequency between 200kHz and 2MHz. Do not leave this pin open.

SYNC/SPRD (Pin 17): Synchronization Pin. To override the programmed switching frequency, drive this pin with an external clock having a frequency between 200kHz and 2MHz. Even when using the external clock, select an R_T resistor that corresponds to the desired switching frequency. Tie the pin to INTV_{CC} to enable spread spectrum frequency modulation. This pin should be tied to GND when not in use.

RP (Pin 18): PWM Resistor Pin. Connect a resistor from this pin to GND to set the frequency of the internal PWM signal. Do not use a resistor larger than 1M Ω . If using an external PWM pulse for LED dimming, tie this pin to GND. Refer to the Applications Information section for a detailed explanation.

PWM (Pin 19): PWM Input Pin. With the RP pin tied to GND, drive this pin with a digital pulse to control PWM dimming of the LEDs. Alternatively, set the voltage of this pin between 1V and 2V to generate an internal pulse with duty cycle between 0% and 100%. The LT8386 also features preset PWM dimming ratios 1, 2, and 3 that generate very precise and consistent PWM ratios of 1%, 5%, and 10%, when the PWM pin voltages are 0.3V, 0.5V, and 0.7V, respectively. When using an analog signal, put a 1 μF bypass capacitor between this pin and GND.

PWMTG (Pin 20): PWM Driver Output Pin. This pin can drive the gate of an external high-side PMOS device for PWM dimming of LEDs or output short protection. Do not force any voltage on this pin.

V_{OUT} (Pins 21, 24): Output Pins. Connect to the output and place output capacitors between this pin and GND as close as possible to the package. Refer to the Applications Information section for the recommended capacitor placements.

GND (Pins 22, 23, Exposed Pad Pin 29): Ground Pins. All GND pins must be soldered to the board ground plane.

Corner Pins: These pins are for mechanical support only and can be tied anywhere on the PCB.

BLOCK DIAGRAM

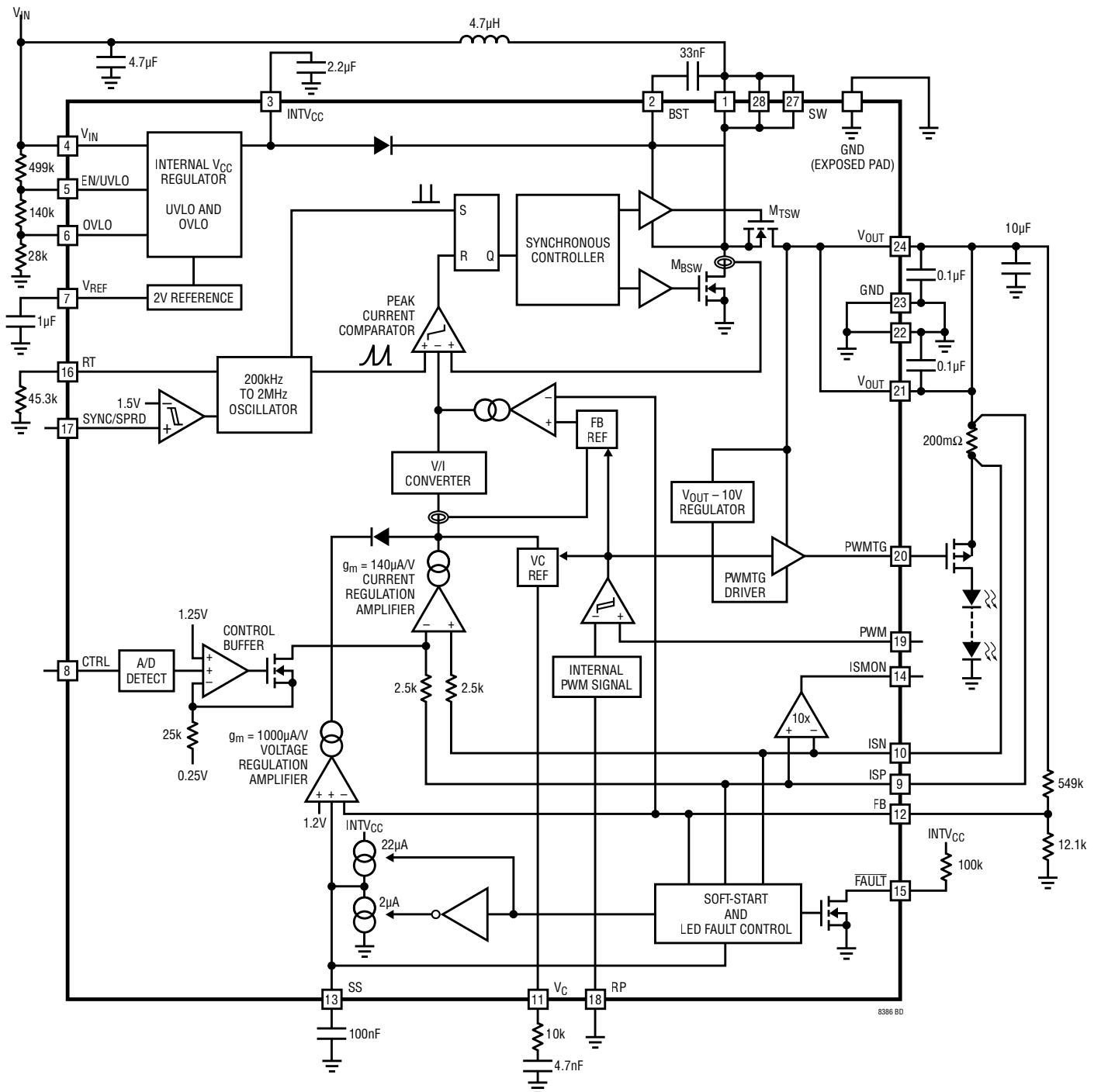

OPERATION

The LT8386 is a Silent Switcher step-up LED driver that utilizes fixed-frequency peak current control to accurately regulate the current through a string of LEDs. It includes two power switches, their drivers, and a diode for providing power to the top switch driver. The switches connect the external inductor terminal connected to the SW pin alternately to the ground and then to the output (V_{OUT}). The inductor current rises and falls accordingly and the peak current can be regulated by adjusting the duty ratio of the power switches through the combined effect of the other circuit blocks.

The synchronous controller ensures the power switches do not conduct at the same time, and a programmable oscillator turns on the bottom switch at the beginning of each switching cycle. The frequency of this oscillator is set by an external resistor at the RT pin and can be overridden by external pulses at the SYNC/SPRD pin. The SYNC/SPRD pin can also be used to command spread spectrum frequency modulation (SSFM), which reduces radiated and conducted electromagnetic interference (EMI).

The bottom switch is turned off by the peak current comparator which waits during the on-time for the increasing inductor current to exceed the target set by the voltage at the V_C pin. This target is modified by a signal from the oscillator which stabilizes the inductor current. A network of passive components at the V_C pin is necessary to stabilize this regulation loop.

The target for the inductor current is derived from the desired LED current programmed by the voltage at the CTRL pin. The analog-or-digital detector and the control buffer convert either a DC voltage or duty cycle of pulses at the CTRL pin into the input for the current regulation

amplifier. The other input to this amplifier comes from the ISP and ISN pin voltages. An external current sense resistor between these pins should be placed in series with the string of LEDs such that the voltage across it provides the feedback to regulate the LED current. The current regulation amplifier then compares the actual LED current to the desired LED current and adjusts V_C as necessary.

The voltage regulation amplifier overrides the current regulation amplifier when the FB pin voltage is higher than an internal 1.2V reference. An external resistor network from the LED string to the FB pin provides an indication of the LED string voltage and allows the voltage amplifier to prevent overvoltage of the LED string.

The ISP, ISN, and FB pin voltages are also monitored to detect fault conditions like open and short circuits, which are then reported by pulling FAULT pin low. The response to a fault can be selected either to try hiccup restarts or to latching off by the choice of an external resistor connected to the SS pin. Refer to the Applications Information section for a detailed explanation of fault responses.

Finally, pulse-width modulation (PWM) of the LED current is achieved by turning on and off an external PMOS switch between the V_{OUT} and the string of LEDs. An external pulse at the PWM pin controls the state of the PWM driver or a DC voltage at the PWM pin dictates the duty ratio of an internal PWM pulse, whose frequency is programmed with an external resistor at the RP pin. After each pulse, when the PMOS switch opens, the LT8386 controls the voltages of the capacitors at V_C and V_{OUT} to ensure a rapid recovery for the next pulse.

APPLICATIONS INFORMATION

The following is a guide to selecting the external components and configuring the LT8386 according to the requirements of an application.

Programming LED Current with the CTRL Pin

The primary function of the LT8386 is to regulate the current in a string of LEDs. This current should pass through a series current sense resistor. The voltage across this resistor is sensed by the current regulation amplifier through the ISP and ISN pins and regulated to a level programmed by the CTRL pin. The maximum resistor voltage that can be programmed is 100mV which corresponds to 1A through the LED string when a 100mΩ current sense resistor is used.

To allow for this maximum current, the CTRL pin may be connected directly to the V_{REF} pin which provides an accurate 2V reference. Lower current levels can be programmed by DC CTRL voltages between 0.25V and 1.25V as shown in Figure 1.

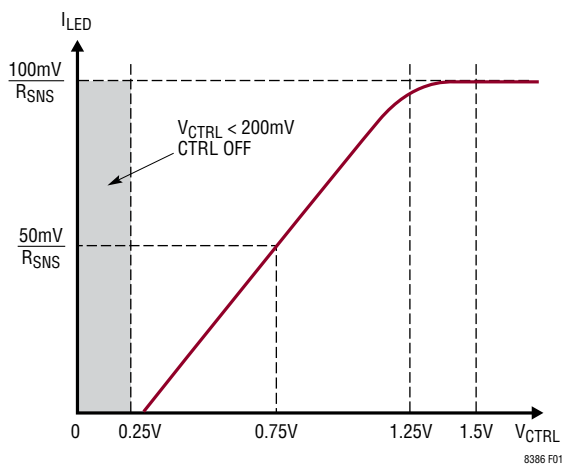

Figure 1. Analog CTRL Range

Below 0.25V, the CTRL pin commands zero LED current, and above 1.25V, it commands the maximum. When an independent voltage source is not available, the intermediate CTRL voltages may be derived from the 2V reference at the V_{REF} pin using a resistor network or potentiometer as long as the total current drawn from the V_{REF} pin is less than 1mA.

Additionally, the LT8386 is capable of interpreting a digital pulse at the CTRL pin. The high level of the pulse must be greater than 1.6V. The low level must be less than 0.4V. The frequency must be between 10kHz and 200kHz. Then the regulated voltage between ISP and ISN will vary with the duty ratio of the pulse as shown in Figure 2.

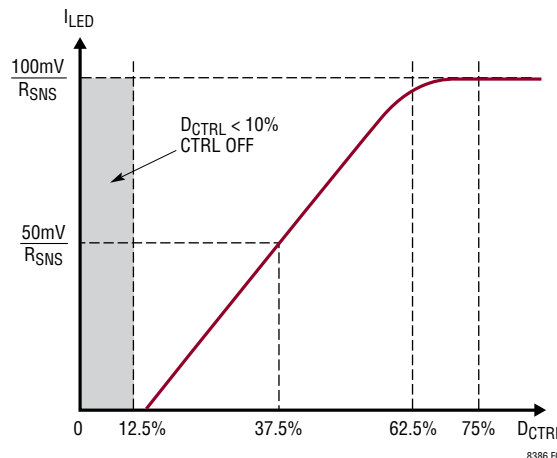

Figure 2. Duty Cycle CTRL Range

In this case, the LED current is zero for duty cycles less than 12.5% and reaches its maximum above 62.5%. The LT8386 will cease switching if the duty cycle of the CTRL pin pulse is less than 10%, and also for DC CTRL pin voltages less than 200mV.

To reduce the LED current when the temperature of the LEDs rise, use a resistor with negative temperature coefficient (NTC) in the network from V_{REF} to CTRL as shown in Figure 3.

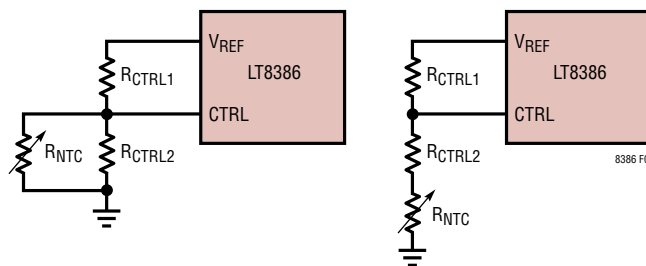

Figure 3. Setting CTRL with NTC Resistors

APPLICATIONS INFORMATION

Setting Switching Frequency with the RT Pin

The switching frequency of the LT8386 is programmed by a resistor connected between the RT pin and GND. Values of the R_T resistor from 45.3k up to 499k program frequencies from 2MHz down to 200kHz as shown in Table 1. Higher frequencies allow for smaller external components but increase switching power losses and radiated EMI.

Table 1. R_T Resistance Range

SWITCHING FREQUENCY	R_T
2MHz	45.3k
1.6MHz	57.6k
1.2MHz	78.7k
1MHz	95.3k
400kHz	249k
210kHz	499k

Synchronizing Switching Frequency

The switching frequency can also be synchronized to an external clock connected to the SYNC/SPRD pin. The high level of the external clock must be at least 1.6V, and the low level must be below 0.8V. The frequency must be between 200kHz and 2MHz. The R_T resistor is still required in this case, and the resistance should correspond to the frequency of the external clock. If the external clock ever stops, the LT8386 will rely on the R_T resistor to set the frequency.

Enabling Spread Spectrum Frequency Modulation

Connecting SYNC/SPRD to INTV_{CC} will enable spread spectrum frequency modulation (SSFM). The switching frequency will vary from the frequency set by the R_T resistor to 125% of that frequency. If neither synchronization nor SSFM is required, connect SYNC/SPRD to GND.

As shown in Figure 4, enabling SSFM can significantly attenuate the electromagnetic interference that the LT8386, like all switching regulators, emits at the switching frequency and its harmonics. This feature is designed to help devices that include the LT8386 perform better in the various standard industrial tests related to interference.

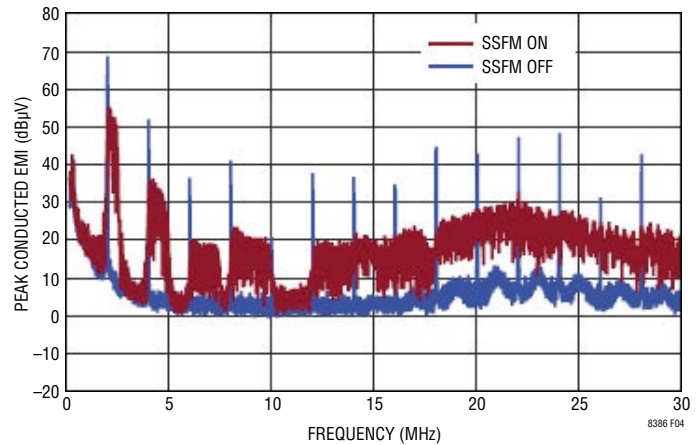

Figure 4. Typical Conducted Peak EMI of the LT8386 with 2MHz Switching Frequency

The attenuation varies depending on the chosen switching frequency, the range of frequencies in which interference is measured, and whether a test measures peak, quasi-peak, or average emissions. The results of several other emission measurements are with select typical application circuits.

Maximum Duty Cycle

The choice of switching frequency should be made knowing that the maximum V_{OUT} voltage of a boost converter is determined by the maximum duty cycle for a given V_{IN} voltage as shown in the following equation:

$$V_{OUT} = \frac{V_{IN}}{(1-D)} \quad (1)$$

where D is the duty cycle of the boost converter defined as the ratio of the on-time of the bottom power switch to the total switching period. The maximum duty cycle for a given switching frequency is determined by the minimum off-time of the bottom power switch. The longest minimum off-time of the LT8386 is 35ns, so the maximum duty cycle is 93% at 2MHz switching frequency. Therefore, if an application requires higher duty cycle, the switching frequency should be set lower to achieve the demanded duty cycle.

APPLICATIONS INFORMATION

Adaptive Peak Switch Current Limit

The LT8386 peak switch current limit is 3.6A (typical) when the V_{IN} pin voltage is 9V and above. This means the inductor peak current can rise up to 3.6A to deliver the programmed LED current to the output. When the V_{IN} pin voltage decreases, the current limit is adaptively increased so that the part can provide more power to the output compared to the fixed 3.6A input current limit case. The current limit increases up to 5A when the V_{IN} pin voltage is 5V and below. Figure 5 illustrates this adaptive peak switch current limit over V_{IN} pin voltages.

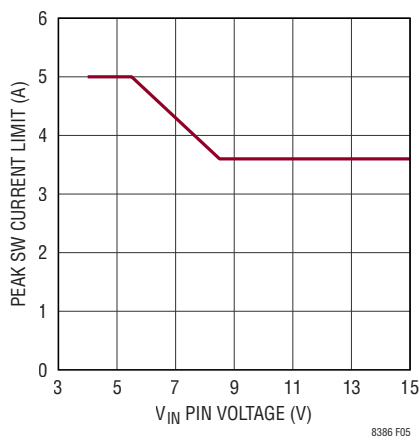

Figure 5. Adaptive Peak Switch Current Limit

Selecting an Inductor

The LT8386 limits the inductor peak current to an input current limit I_{LIM} , which is a function of the V_{IN} pin voltage, over the duty cycle without subharmonic oscillations. This current limit will override the CTRL pin input command if the programmed LED current demands higher inductor peak current than I_{LIM} . Therefore, it is important to select the inductor value to ensure the peak inductor current is below the limit over the desired input voltage range. The following is an example of inductor value decision process for the application where we want 500mA LED current at 45V output, while the input ranges from 9V to 25V and the switching frequency is 2MHz. The I_{LIM} in this example will be 3A, which is the minimum I_{LIM} that LT8386 guarantees with 9V input voltage. The maximum peak inductor current can be derived by adding the half of

the inductor current ripple amplitude to the average inductor current value, both values of which are determined by the input and output voltages, switching frequency, efficiency and the inductor values. Hence, the minimum inductor value L_{MIN} that ensures the peak inductor current below 3A is:

$$L_{MIN} = \frac{\left(\frac{V_{IN(MIN)} \cdot (V_{OUT} - V_{IN(MIN)})}{2 \cdot V_{OUT} \cdot f_{SW}} \right)}{\left(3 - \frac{V_{OUT} \cdot I_{LED}}{V_{IN(MIN)} \cdot \text{EFFICIENCY}} \right)} \quad (2)$$

Using this equation gives an inductance of about 8.1 μ H assuming 90% efficiency for the given conditions.

With this minimum inductor value guideline, choose an inductor with low core loss and low DC resistance. Inductor must be able to handle the peak inductor current without saturation. To minimize the radiated noise, use a shielded inductor. The manufacturers featured in Table 2 are recommended sources of inductors.

Table 2. Inductor Manufacturers

MANUFACTURER	WEBSITE
Würth Electronics	www.we-online.com
Coilcraft	www.coilcraft.com
Vishay Intertechnology	www.vishay.com

Selecting an Input Capacitor

The input capacitor supplies the inductor ripple current and the transient current that occurs in PWM dimming operations. A 4.7 μ F ceramic capacitor should be sufficient to provide these non-steady state currents. Place the input capacitor close to the inductor. If possible, place an additional 1 μ F ceramic capacitor close to the V_{IN} pin for better noise immunity. Use X7R ceramic capacitors as they typically retain their capacitance better than other capacitor types over wide voltage and temperature ranges.

If the input power source has high impedance, or there is significant inductance due to long wires or cables, additional bulk electrolytic capacitance may be necessary. A low ESR ceramic input capacitor combined with parasitic

APPLICATIONS INFORMATION

inductances in the current paths can form a high-Q LC tank circuit which can ring the capacitor voltage up to twice the input voltage. A higher ESR electrolytic capacitor, on the other hand, minimizes this ringing. Refer to the Linear Technology Application Note 88 for more information. Sources of quality ceramic and electrolytic capacitors are listed in Table 3.

Table 3. Capacitor Manufacturers

MANUFACTURER	WEBSITE
Murata Manufacturing	www.murata.com
TDK	www.global.tdk.com
Panasonic	www.industrial.panasonic.com

Stabilizing the Regulation Loop

The LT8386 uses internal error amplifiers to regulate the LED current and the output voltage to the user programmed values. The output impedance of the error amplifiers and the external compensation capacitor, C_C , connected to V_C pin create the dominant pole of the control loop. The compensation resistor, R_C , in series with C_C forms a left-half-plane (LHP) zero. This LHP zero allows better regulation of LED current and output voltage during transient operations. For most LED applications, 1nF and 10k would be good starting values for C_C and R_C , respectively. Refer to the Linear Technology Application Note 76 for more information.

Selecting and Placing Output Capacitors

The output capacitor needs to have very low ESR to reduce the output ripple. Placing several low ESR ceramic capacitors in parallel is an effective way to reduce ESR. These output capacitors in a boost converter should have a ripple current rating greater than the half of the maximum SW pin current. Use X7R ceramic capacitors as they typically retain their capacitance better than other capacitor types over wide voltage and temperature ranges.

The LT8386 utilizes a proprietary architecture to reduce EMI noise generated by switching. Figure 6 shows the V_{OUT} capacitor placement for the LQFN package.

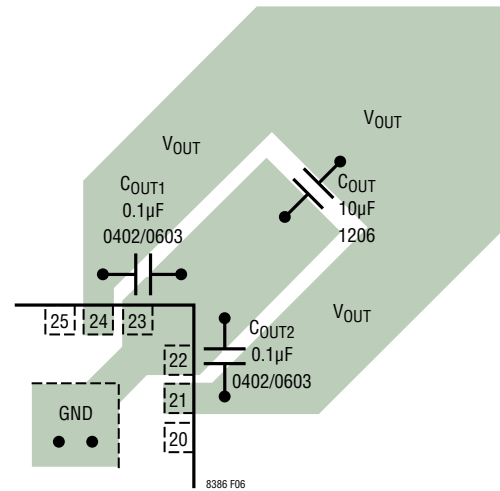

Figure 6. Placement of Output Capacitors

Selecting a MOSFET for PWM Dimming

Pulse-width-modulation (PWM) dimming of the LED current is an effective way to control the brightness of the light without varying its color. The brightness can also be adjusted with finer resolution this way than by varying the current level.

The LT8386 features a high-side PWM driver that allows a high voltage PMOS switch to be positioned at the top of the LED string after the output capacitor and the current sense resistor. The high-side PWM driver is similar to a low-side NMOS driver because in both cases the LED current will be zero when the switch is open and the string is disconnected, but in contrast the high-side PMOS feature eliminates the need for a dedicated return path for the LED current in automotive applications or other grounded chassis systems.

APPLICATIONS INFORMATION

The gate driver for this PMOS is supplied through the V_{OUT} pin. When the PWM pin voltage is greater than 1.7V, the driver will pull the gate of the PMOS to a maximum of 12.5V below the V_{OUT} pin. If V_{OUT} is below 12.5V, the gate drive is necessarily reduced. For constant current applications, leave PWMTG open, connect the load directly after the current sense resistor, and connect PWM to $INTV_{CC}$. In these cases, analog dimming may be implemented with the CTRL pin.

The drain source voltage rating of the chosen PMOS should be greater than the maximum output voltage. Typically the output voltage is a little higher than the sum of the forward voltages of the LEDs in the string. However, when the string is broken, the output voltage will begin to increase due to the imbalance of inductor current and load current. As described in detail later, the LT8386 will not reduce the inductor current nor limit the output voltage until the FB pin voltage approaches 1.2V. Therefore, the maximum output voltage is ultimately determined by the resistor network between FB and V_{OUT} .

In most applications, the gate source voltage rating of the PMOS should be at least 10V. The only exceptions to this rule are applications for which the output voltage is always less than 10V. The PWMTG driver will try to pull the gate of the PMOS down to 10V below V_{OUT} , but it cannot pull the gate below GND. Therefore, when the maximum output voltage is less than 10V, the PMOS gate source voltage rating will be sufficient if it is merely equal to or greater than the output voltage.

Finally, the drain current rating of the PMOS must exceed the programmed LED current. Assuming this condition and the conditions above are met, the only electrical parameter to be considered is the on-resistance. Other parameters such as gate charge are less important because PWM dimming frequencies are typically too low for efficiency to be affected noticeably by gate charging loss or transition loss.

Table 4 lists recommended manufacturers of PMOS devices.

Table 4. PMOS Manufacturers

MANUFACTURER	WEBSITE
Infineon	www.infineon.com
Vishay Intertechnology	www.vishay.com
NXP Semiconductors	www.nxp.com

Selecting an R_P Resistor for Internal PWM Dimming

If the R_P pin is tied to GND, an external pulse-width modulated signal at the PWM pin will control PWM dimming of the LED load. The signal will enable the PWMTG driver and turn on the external PMOS device when it is higher than 1.7V.

However, the LT8386 is capable of PWM dimming even when an external PWM signal is not available. In this case, an internal PWM signal with frequency set by a resistor at the R_P pin and duty ratio set by a DC voltage at the PWM pin will control the PWMTG driver. The R_P resistor should be one of the five values listed in Table 5. For each of these values, the PWM frequency is a unique ratio of the switching frequency.

Table 5. Internal PWM Dimming Frequencies

RP	RATIO	SWITCHING FREQUENCY		
		2MHz	1MHz	400kHz
76.8k	2^{10}	1.95kHz	977Hz	390Hz
118k	2^{11}	977Hz	488Hz	195Hz
169k	2^{12}	488Hz	244Hz	98Hz
237k	2^{13}	244Hz	122Hz	49Hz
332k	2^{14}	122Hz	61Hz	24Hz

APPLICATIONS INFORMATION

The internal PWM function of the LT8386 maps the PWM pin voltages to the PWM dimming ratios as illustrated in Figure 7. When V_{PWM} is greater than 2V, the PWM dimming ratio is 100% and the PWMTG switch will stay on. Between 1V and 2V, there are 512 evenly spaced voltage thresholds corresponding to 512 discrete PWM dimming ratios from 0% to 100%. The LT8386 provides Preset PWM dimming ratios that significantly enhance the precision of the dimming ratio and reduce the noise sensitivity at the PWM pin. Applying 0.3V, 0.5V, and 0.7V at the PWM pin results in very accurate 1%, 5%, and 10% PWM dimming ratios, respectively. In between the preset PWM ranges, the dimming ratio is 0% and the PWMTG will stay off.

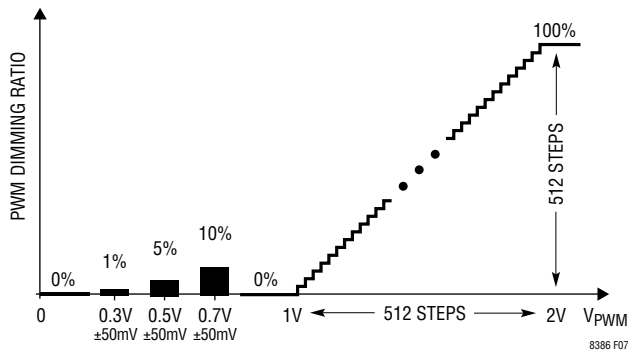

Figure 7. The Internal PWM Mapping of the LT8386

To avoid excessive start-up times, after the first PWM pulse, PWMTG will stay on until the SS pin voltage reaches 1.55V or the LED current has reached approximately 10% of the full-scale current. This expedited start-up applies to both internal and external PWM operations.

Monitoring LED Current

The ISMON pin provides an amplified and buffered monitor of the voltage between the ISP and ISN pins. The gain of the internal amplifier is 10, and the speed is fast enough to track the pulse-width modulated LED current. However, as shown in Figure 8, the ISMON voltage can be filtered with a resistor-capacitor network to monitor the average LED current instead.

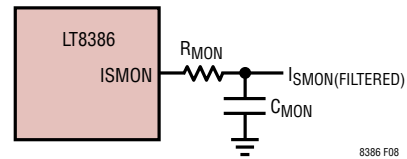

Figure 8. ISMON Filter Configuration

The resistor should be at least 10k. The capacitance can be as large or small as needed without affecting the stability of the internal amplifier. For example, when the PWM frequency is 200Hz, a 10 μ F capacitor combined with the 10k resistor would limit the ripple on ISMON to 1%.

Selecting the FB Resistors

Two resistors should be selected to form a network between the output voltage and the FB pin as shown in Figure 9.

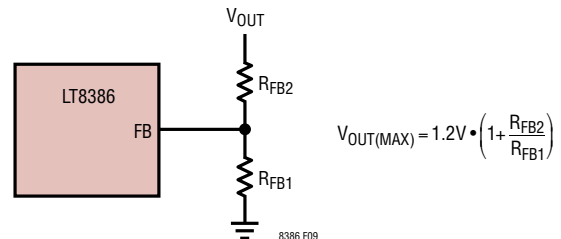

Figure 9. FB Resistor Configuration

APPLICATIONS INFORMATION

This network forms part of a voltage regulation loop when FB is near 1.2V. In this case, the LT8386 will override the programmed LED current and adjust the inductor current to lower the output voltage and limit FB to 1.2V. This resistor configuration therefore determines the maximum output voltage.

In this way, the LT8386 can also be configured as a voltage regulator instead of an LED driver. It will regulate the output voltage near the programmed maximum as long as the load current is less than the current programmed by CTRL.

Note that this voltage limit may be reached inadvertently if it is set too close to the typical output voltage and the output capacitor is too small. To avoid interference with the current regulation, the feedback resistors should be chosen such that FB is below 1.14V when the LEDs are conducting.

Understanding FB Overvoltage Lockout

Despite the voltage regulation loop, the FB voltage can temporarily exceed the 1.2V limit. If the output voltage is near the maximum when the LED string opens, it may take too long for the feedback loop to adjust the inductor current and avoid overcharging the output. To quickly respond to the overvoltage conditions, the LT8386 will immediately stop switching and disconnect the LED string by shutting the external PMOS off when the FB pin exceeds the 1.266V FB overvoltage lockout threshold.

The FB overvoltage lockout threshold may be routinely exceeded when the LT8386 is being operated as a voltage regulator if the load current decreases rapidly. In this case, the pause in switching limits the output overshoot and ensures that the voltage is back in regulation as quickly as possible. For safe operation, choose R_{FB1} and R_{FB2} values to ensure the output voltage is not greater than 60V when the FB voltage is 1.266V.

Open LED Fault Detection and Response

The resistor network formed by R_{FB1} and R_{FB2} also defines the criteria for the open-LED fault condition. An open-LED fault is detected when the FB pin voltage is greater than 1.14V and simultaneously the difference between ISP and ISN pins is less than 10mV. The latter condition ensures that the output current is low (as it should be in an open circuit) not just that output voltage is high as it may be when the LEDs are conducting a large current.

A fault is reported by an internal device pulling the voltage at the FAULT pin low. There is nothing internal that pulls this voltage high, so an external resistor between $INTV_{CC}$ and \overline{FAULT} is necessary as shown in Figure 10. This configuration allows multiple \overline{FAULT} pins and similar pins on other parts to be connected and share a single resistor.

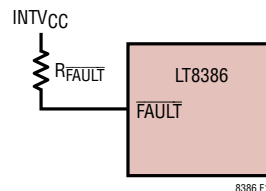

Figure 10. \overline{FAULT} Resistor Configuration

Shorted LED Fault Detection and Responses

The LT8386 prevents excessive currents that could damage the LED and the driver by two detection schemes as follows:

- 1) $(V_{ISP} - V_{ISN}) > 150\text{mV}$ for more than 300 μs , or
- 2) $(V_{ISP} - V_{ISN}) > 700\text{mV}$ (typical)

If the LT8386 detects any one of these events, it immediately stops switching, turns off the external PMOS PWM switch, pulls down \overline{FAULT} pin, and initiates a fault response routine using the SS pin. Note that \overline{FAULT} pin is held low until the part successfully restarts.

APPLICATIONS INFORMATION

Soft-Start and Fault Modes

The LT8386’s soft-start (SS) pin has two functions. First, it allows the user to program the output start-up voltage ramp rate through the SS pin. An internal 22μA current pulls up the SS pin to INTV_{CC}. As shown in Figure 11, connecting an external capacitor C_{SS} at the SS pin to GND will generate a linear ramp voltage. This voltage ramp at the SS pin forces the LT8386 to regulate the FB pin voltage to track the SS pin voltage until V_{OUT} is high enough to drive the LED at the commanded current level.

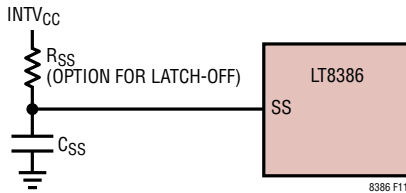

Figure 11. SS Capacitor and Resistor Configuration

The SS pin is also used as a fault timer. After a shorted LED fault is detected, an internal 2μA current pulls down the voltage on the SS pin. The user can configure two different fault response routines by using or not using a pull-up resistor, R_{SS}, from the SS pin to INTV_{CC}. Figure 12a and Figure 12b illustrate corresponding waveforms of the SS pin voltage for the two responses: latching and hiccup mode. With a 470k or smaller R_{SS}, the LT8386 will latch off until the user forces a reset by toggling the EN/UVLO pin. Without the R_{SS}, the LT8386 enters a hiccup mode operation. The 2μA pulls SS pin down to 0.2V, at which point the 20μA pull-up current turns on again to raise the SS pin voltage. If the fault condition has not been removed until the SS pin reaches 1.55V, the 2μA pull-down current source turns on again to start another cycle. This hiccup mode will continue until the fault is cleared. A typical C_{SS} value is 100nF.

Programming EN/UVLO and OVLO Thresholds

The LT8386 will stop switching, disable the PWM TG driver, and reset the soft-start when the voltage at the EN/UVLO pin drops below 1.33V, or the voltage at the OVLO pin rises above 1.205V. External voltage sources

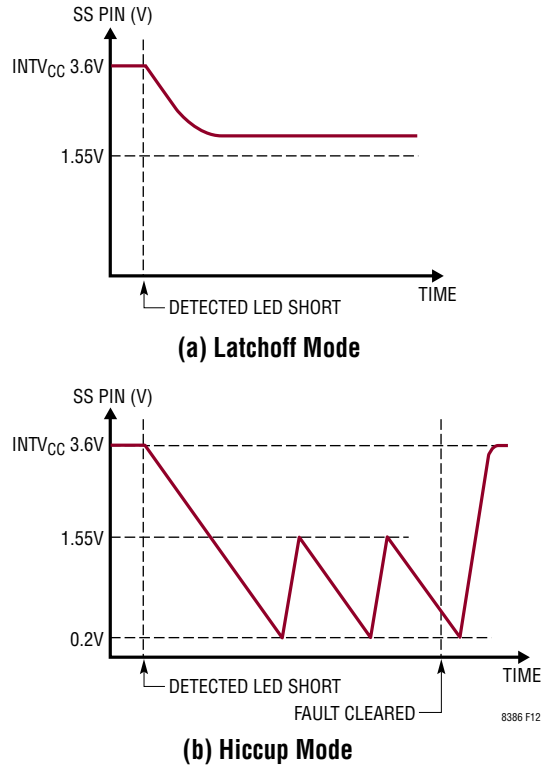

Figure 12. Fault Responses: (a) Latchoff and (b) Hiccup

can be used to set the voltage at EN/UVLO and OVLO pins to enable or disable the LT8386. Alternatively, resistor networks can be placed from V_{IN} to these pins to set the operating range of the V_{IN} voltage.

For instance, the V_{IN} undervoltage lockout (UVLO) threshold can be accurately set by an external resistor divider. Figure 13 illustrates how to set the falling EN/UVLO threshold and the rising hysteresis voltages in LT8386. The internal hysteresis is 25mV, but the user can program additional hysteresis through the external resistor as the

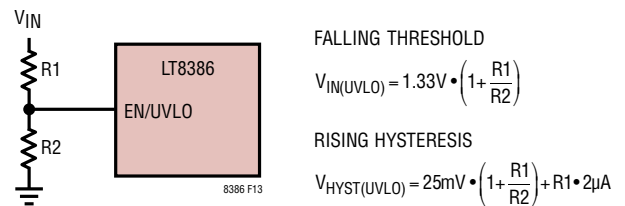

Figure 13. EN/UVLO Threshold and Hysteresis Voltages

APPLICATIONS INFORMATION

EN/UVLO pin sinks 2μA current when the EN/UVLO pin voltage is below the threshold.

On the other hand, the V_{IN} overvoltage lockout (OVLO) threshold can be accurately set by the external resistor divider as well. Figure 14 illustrates how to set the rising OVLO threshold in LT8386. The internal hysteresis of the OVLO pin is 50mV.

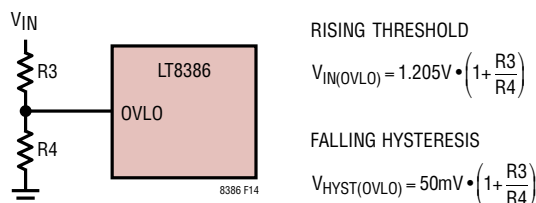

Figure 14. OVLO Threshold and Hysteresis Voltages

Both EN/UVLO and OVLO can be set precisely using a single resistor string consisting of three series resistors. Figure 15 shows the resistor string and the threshold and hysteresis voltages for EN/UVLO and OVLO.

Tie EN/UVLO to V_{IN} and tie OVLO to GND if they are not used. Do not leave these pins open.

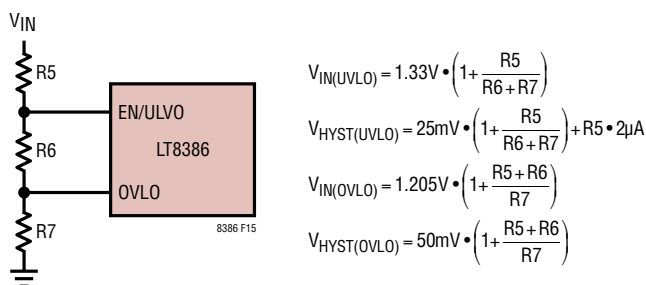

Figure 15. EN/UVLO — OVLO Threshold and Hysteresis Voltages

Planning for Thermal Shutdown

The LT8386 automatically stops switching when the internal temperature is too high. The temperature limit is guaranteed to be higher than the operational temperature of the part. During thermal shutdown, all switching is terminated, SS is forced low, and the LEDs are disconnected through the PWMGT driver. The exposed pad on the bottom of the package must be soldered to a ground plane. Vias placed directly under the package are necessary to dissipate heat.

Designing the Printed Circuit Board (PCB)

The output capacitors C_{OUT1} and C_{OUT2} of the LT8386 bypass large switched currents from V_{OUT} to GND (see Figure 6). The loops travelled by these currents should be made small as possible to these pins. These output capacitors, along with the inductor and the input capacitors, should be placed on the same side of the PCB, and their connections should be made on that layer.

Create a Kelvin ground network by keeping the ground connection for all of the other components separate. It should only join the ground for the input and output capacitors and the return path for the LED current at the exposed pad.

There are a few other aspects of the board design that improve performance. An unbroken ground plane on the second layer dissipates heat, but also reduces noise. Likewise minimizing the area of the SW and BST nodes reduces noise. The traces for FB and V_C should be kept short to lessen the susceptibility to noise of these high-impedance nodes. Matched Kelvin connections from the external current sense resistor to the ISP and ISN pins are essential for current regulation accuracy. Use bypass capacitors for the DC input nodes such as V_{IN} , CTRL, and PWM (for internal PWM) to reduce noise. Keep the RT and RP nodes small and away from noisy signals. Finally, a diode with anode connected to ground and cathode to the drain of the PWMGT MOSFET can protect that device from overvoltage caused by excessive inductance in the LED string. Please refer to the demo board layout of the LT8386 for more information.

TYPICAL APPLICATIONS

2MHz, 300mA Boost LED Driver Using External PWM Dimming

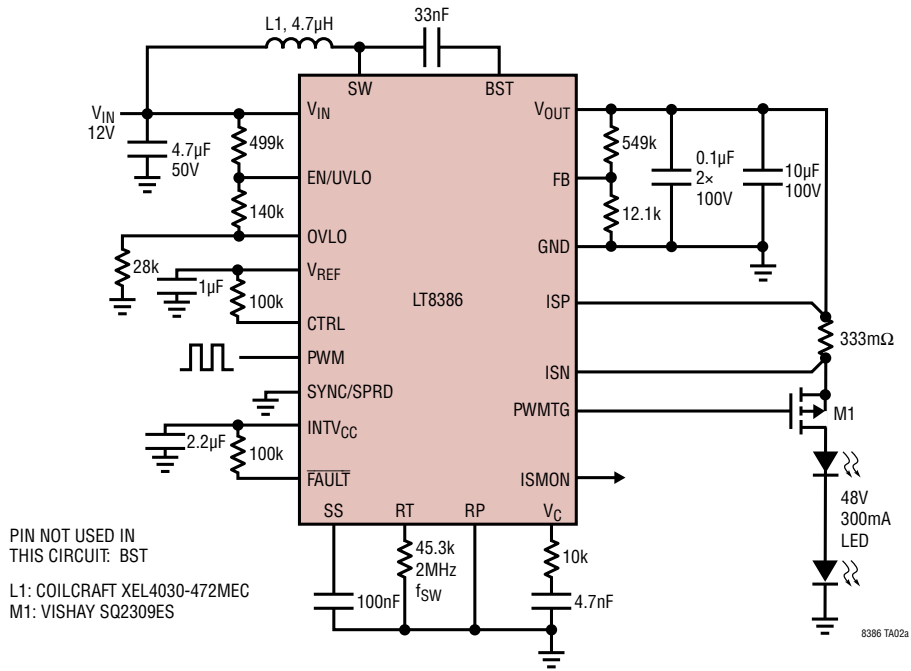

200ns PWM On/
1Hz f_{PWM} (5,000,000:1)

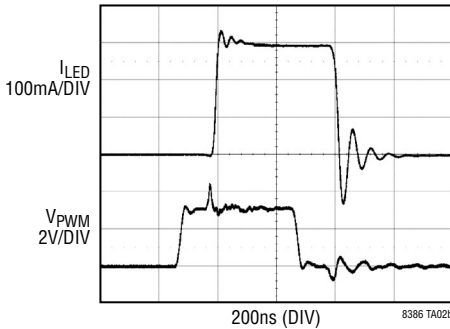

20µs PWM On/
1Hz f_{PWM} (50,000:1)

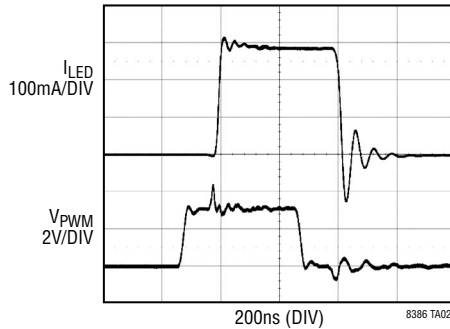

200ns PWM On/
100Hz f_{PWM} (50,000:1)

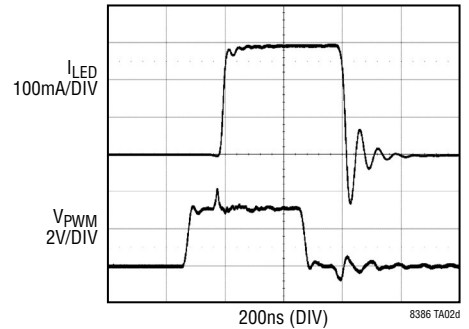

20µs PWM On/
100Hz f_{PWM} (500:1)

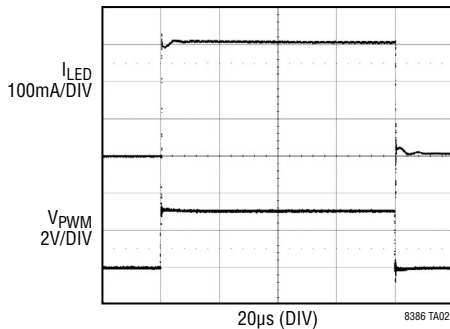

200ns PWM On/
1kHz f_{PWM} (5,000:1)

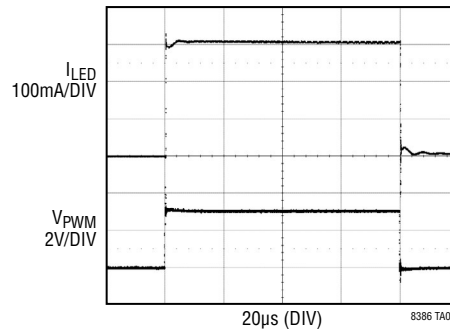

20µs PWM On/
1kHz f_{PWM} (50:1)

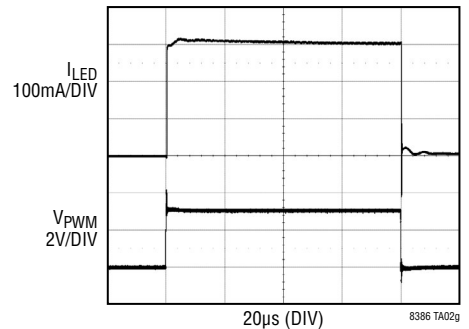

TYPICAL APPLICATIONS

2MHz, 300mA Boost LED Driver Using Internal PWM Dimming

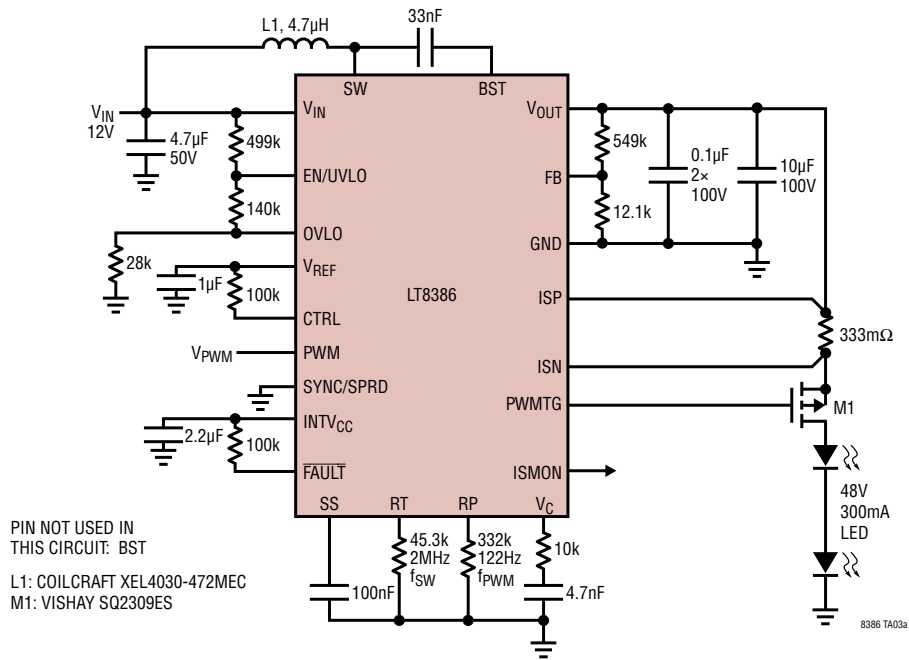

512:1 Internal PWM Dimming

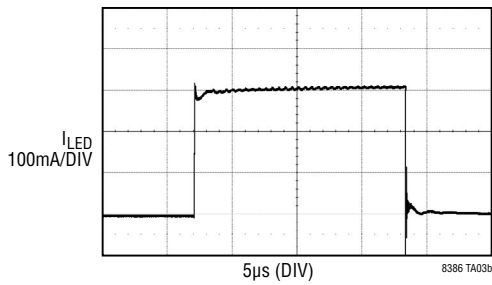

V_{PWM} = 1.003V

Preset PWM Dimming Ratio 1 (100:1)

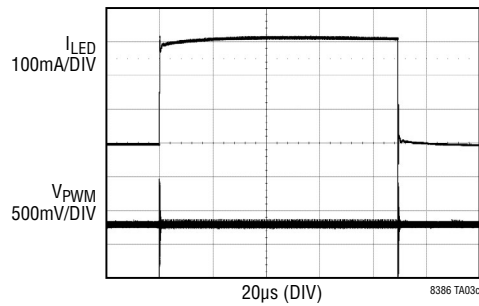

V_{PWM} = 250V TO 350mV NOISY SIGNAL

TYPICAL APPLICATIONS

400kHz, 94% Efficient 9W (18V, 500mA) Buck-Boost Mode LED Driver

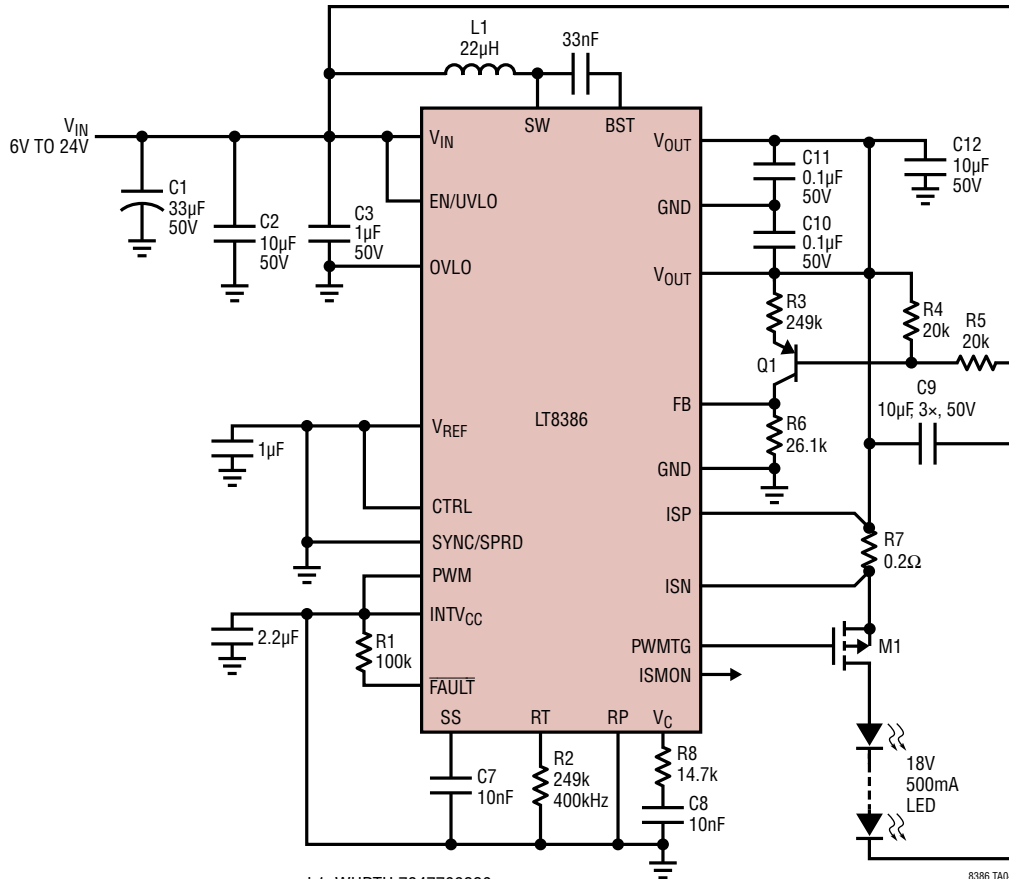

L1: WURTH 7847709220
M1: VISHAY SQ2309ES
Q1: ZETEX FMMT591TA

8386 TA04a

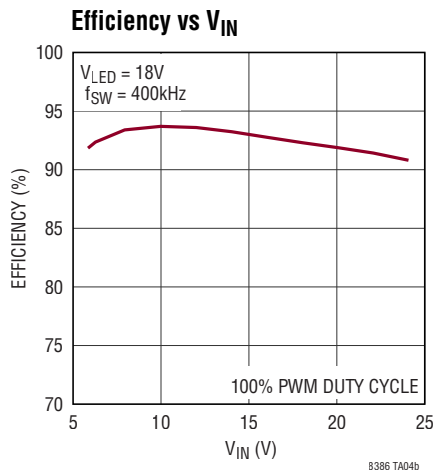

8386 TA04b

5,000:1 External PWM Dimming, 200Hz

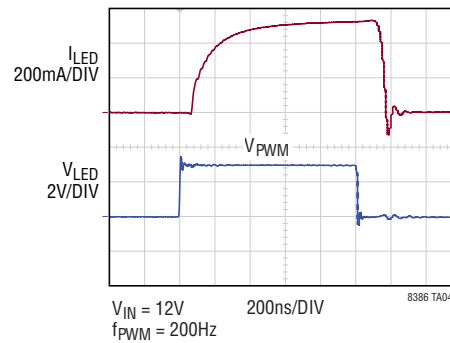

8386 TA04c

PACKAGE DESCRIPTION

LQFN Package
28 (26)-Lead (4mm × 5mm × 0.95mm)
 (Reference LTC DWG # 05-08-1486 Rev 0)

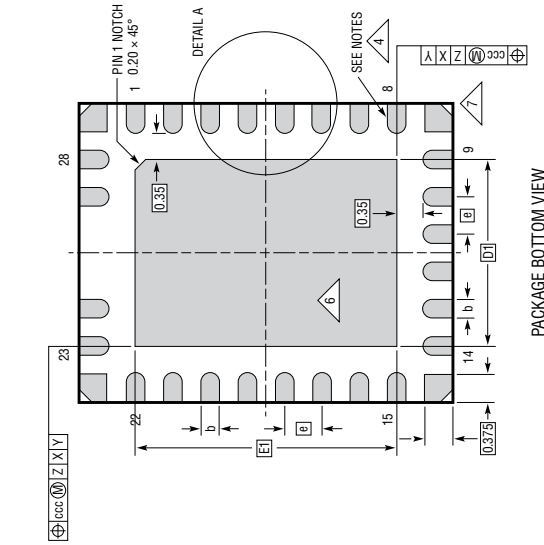

PACKAGE BOTTOM VIEW

- NOTES:
1. DIMENSIONING AND TOLERANCING PER ASME Y14.5M-1994
 2. ALL DIMENSIONS ARE IN MILLIMETERS
 3. PRIMARY DATUM -Z- IS SEATING PLANE
 4. METAL FEATURES UNDER THE SOLDER MASK OPENING NOT SHOWN SO AS NOT TO OBSCURE THESE TERMINALS AND HEAT FEATURES
 5. DETAILS OF PIN 1 IDENTIFIER ARE OPTIONAL, BUT MUST BE LOCATED WITHIN THE ZONE INDICATED. THE PIN 1 IDENTIFIER MAY BE EITHER A MOLD OR MARKED FEATURE
 6. THE EXPOSED HEAT FEATURE MAY HAVE OPTIONAL CORNER RADII
 7. CORNER SUPPORT PAD CHAMFER IS OPTIONAL

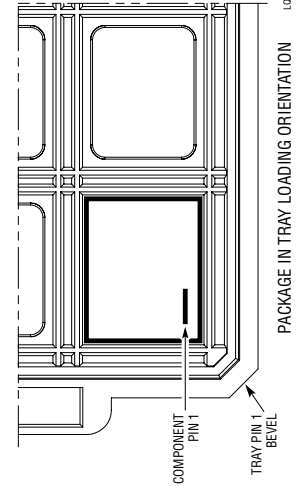

PACKAGE IN TRAY LOADING ORIENTATION

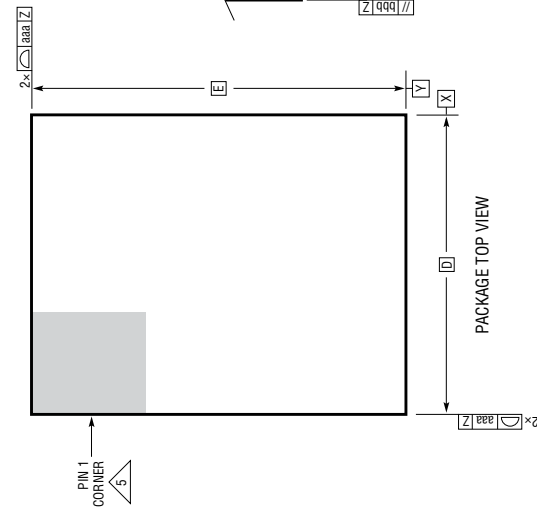
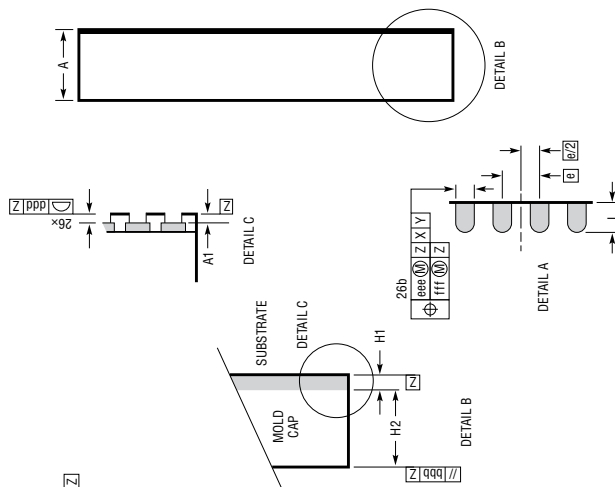

PACKAGE TOP VIEW

SYMBOL	DIMENSIONS			NOTES
	MIN	NOM	MAX	
A	0.85	0.95	1.05	
A1			0.03	
L	0.30	0.40	0.50	
b	0.22	0.25	0.28	
D		4.00		
E		5.00		
D1		2.50		
E1		3.50		
e		0.50		
H1		0.25 REF		SUBSTRATE THK
H2		0.70 REF		MOLD CAP HT
aaa			0.10	
bbb			0.10	
ccc			0.10	
ddd			0.10	
eee			0.15	
fff			0.08	

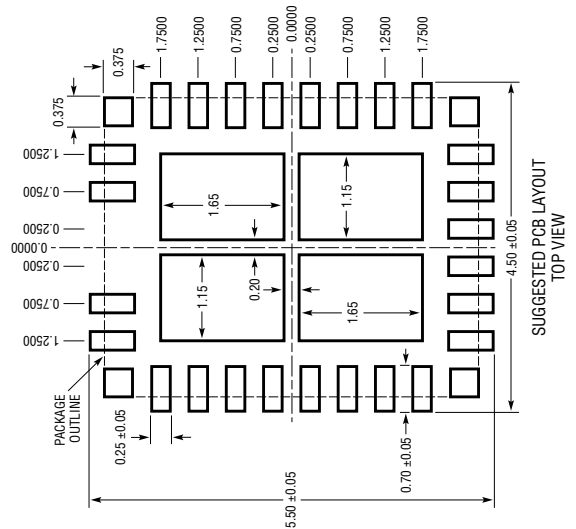

SUGGESTED PCB LAYOUT TOP VIEW

TYPICAL APPLICATION

Low EMI 330kHz, 45V to 500mA Boost LED Driver with SSFM

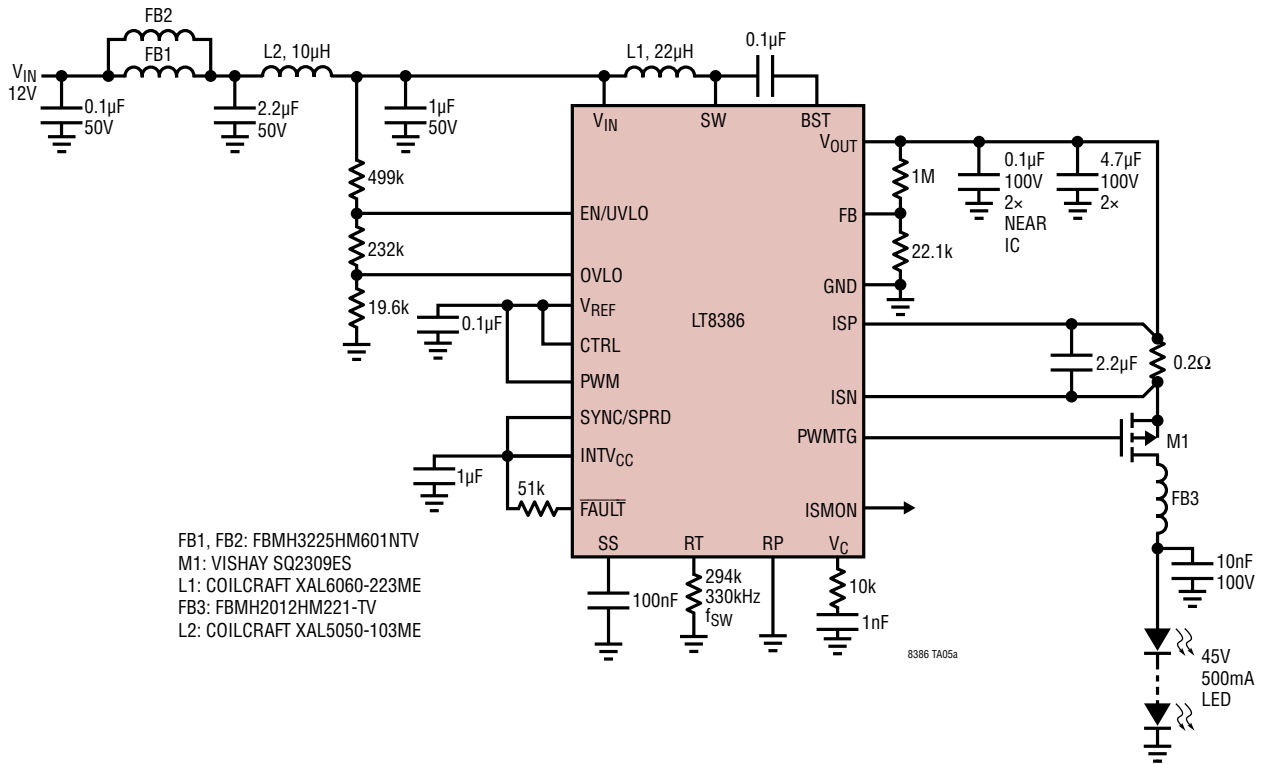

CISPR25 Conducted EMI Performance Current Method

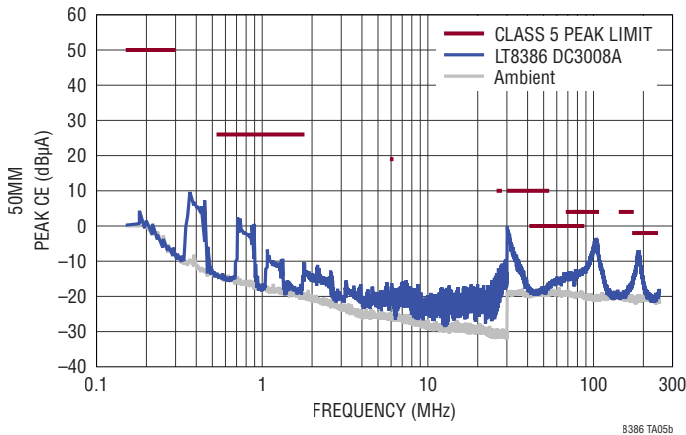

CISPR25 Conducted EMI Performance Current Method

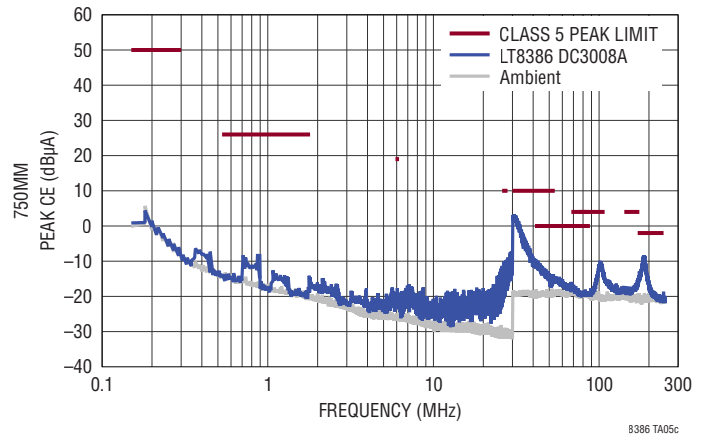

RELATED PARTS

PART NUMBER	DESCRIPTION	COMMENTS
LT3922/3922-1	36V, 2A Synchronous Step-Up LED Driver with 25,000:1 Dimming	$V_{IN} = 2.8V$ to 36V, $V_{OUT(MAX)} = 40V$, 128:1 Internal Dimming and 25,000:1 External Dimming, 4mm x 5mm QFN-28
LT3932/3932-1	36V, 2A Synchronous Step-Down LED Driver	$V_{IN} = 3.6V$ to 36V, $V_{OUT} = 0V$ to 36V, 128:1 Internal Dimming and 5,000:1/10,000+:1 External Dimming, 4mm x 5mm QFN-28
LT3942	36V, 2A Synchronous Buck-Boost Converter and LED Driver	$V_{IN} = 3V$ to 36V, $V_{OUT} = 0V$ to 36V, 128:1 Internal Dimming and 5,000:1 External Dimming, 4mm x 5mm QFN-28