

## GaAs MMIC SPDT NON-REFLECTIVE SWITCH, DC - 18 GHz



### Typical Applications

The HMC-C058 is ideal for:

- Fiber Optics & Broadband Telecom
- Microwave Radio & VSAT
- Military Radios, Radar, & ECM
- Test Instrumentation

### Features

- High Isolation: >65 dB up to 6 GHz  
>50 dB up to 18 GHz
- Low Insertion Loss: 2 dB @ 8 GHz  
2.8 dB @ 12 GHz
- Fast Switching: 3 ns Rise/Fall Times
- Non-Reflective Design
- Hermetically Sealed Module
- Field Replaceable SMA connectors
- 55 to +85 °C Operating Temperature

### General Description

The HMC-C058 is a general purpose broadband high isolation non-reflective GaAs MESFET SPDT switch housed in a miniature hermetic module with field replaceable SMA connectors. Covering DC to 18 GHz, the switch offers high isolation and low insertion loss. The switch features >65 dB isolation up to 6 GHz and >50 dB isolation up to 18 GHz. A CMOS interface allows a single +5V bias voltage at very low DC currents.

### Functional Diagram

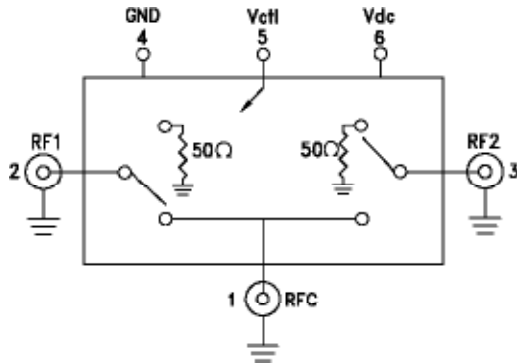

### Electrical Specifications, $T_A = +25^\circ C$ , With $V_{dc} = +5V$ & $0/+5V$ Control, 50 Ohm System

Parameter	Frequency	Min.	Typ.	Max.	Units
Insertion Loss	DC - 6 GHz		1.6	2.4	dB
	DC - 10 GHz		2.0	2.8	dB
	DC - 18 GHz		3.0	5.5	dB
Isolation	DC - 6 GHz	55	65		dB
	DC - 10 GHz	50	60		dB
	DC - 18 GHz	42	55		dB
Return Loss	"On State"	DC - 6 GHz	17		dB
		DC - 18 GHz	12		dB
Return Loss RF1, RF2	"Off State"	DC - 6 GHz	14		dB
		DC - 18 GHz	17		dB
Input Power for 1 dB Compression	0.5 - 18 GHz	24	27		dBm
Input Third Order Intercept (Two-Tone Input Power= +7 dBm Each Tone)	0.5 - 18 GHz		46		dBm
Switching Characteristics	DC - 18 GHz	tRISE, tFALL (10/90% RF)	3		ns
		tON, tOFF (50% CTL to 10/90% RF)	12		ns
		Switching Transients		12	

Information furnished by Analog Devices is believed to be accurate and reliable. However, no responsibility is assumed by Analog Devices for its use, nor for any infringements of patents or other rights of third parties that may result from its use. Specifications subject to change without notice. No license is granted by implication or otherwise under any patent or patent rights of Analog Devices. Trademarks and registered trademarks are the property of their respective owners.

For price, delivery, and to place orders: Analog Devices, Inc., One Technology Way, P.O. Box 9106, Norwood, MA 02062-9106  
Phone: 781-329-4700 • Order online at [www.analog.com](http://www.analog.com)  
Application Support: Phone: 1-800-ANALOG-D

**GaAs MMIC SPDT NON-REFLECTIVE  
SWITCH, DC - 18 GHz**



**Insertion Loss**

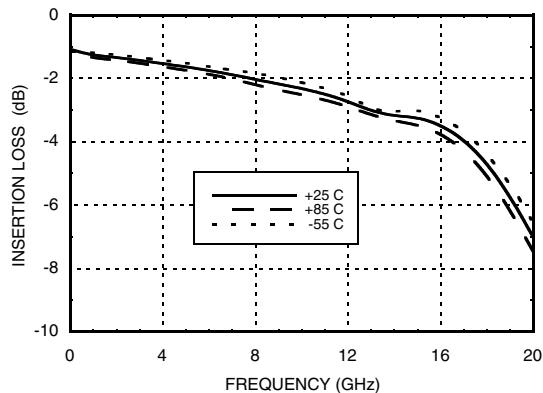

**Return Loss RFC**

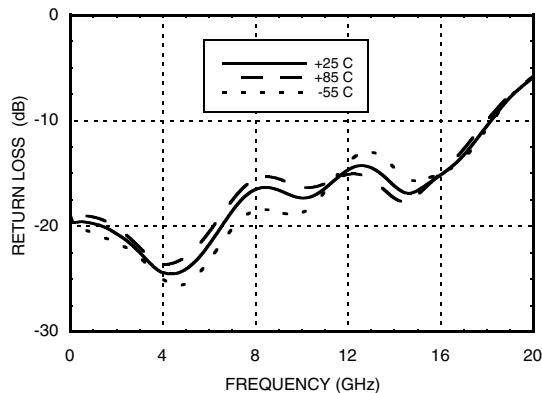

**Return Loss RF1, RF2 On**

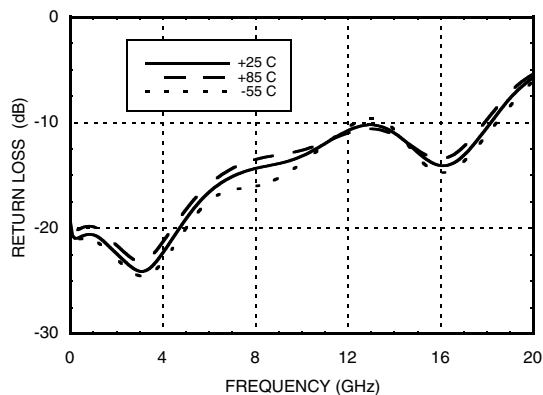

**Return Loss RF1, RF2 Off**

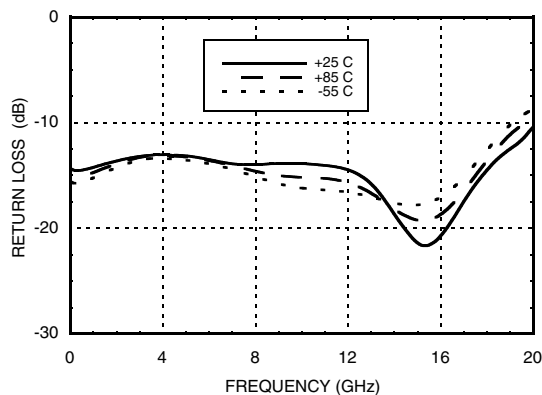

**Isolations**

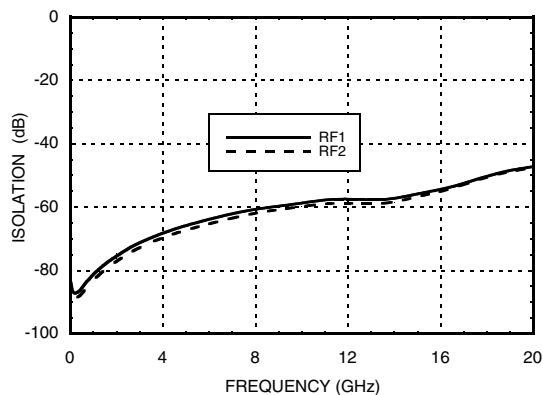

**Isolation Between Ports RF1 and RF2**

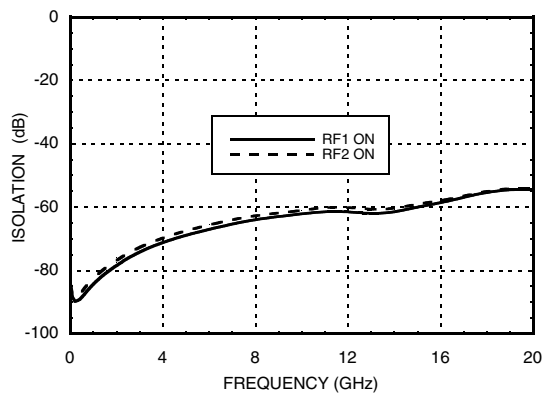

Information furnished by Analog Devices is believed to be accurate and reliable. However, no responsibility is assumed by Analog Devices for its use, nor for any infringements of patents or other rights of third parties that may result from its use. Specifications subject to change without notice. No license is granted by implication or otherwise under any patent or patent rights of Analog Devices. Trademarks and registered trademarks are the property of their respective owners.

For price, delivery, and to place orders: Analog Devices, Inc., One Technology Way, P.O. Box 9106, Norwood, MA 02062-9106 Phone: 781-329-4700 • Order online at [www.analog.com](http://www.analog.com) Application Support: Phone: 1-800-ANALOG-D

**GaAs MMIC SPDT NON-REFLECTIVE  
SWITCH, DC - 18 GHz**



**Input P1dB Compression Point**

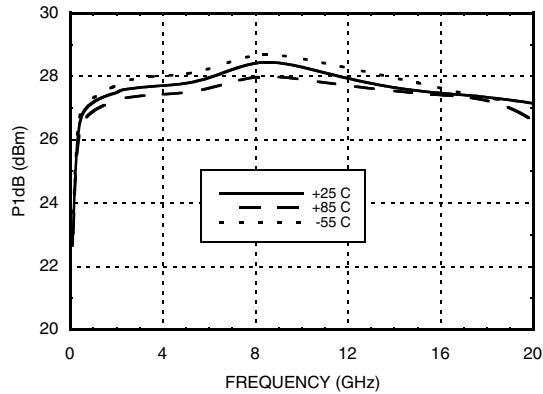

**Input Third Order Intercept Point**

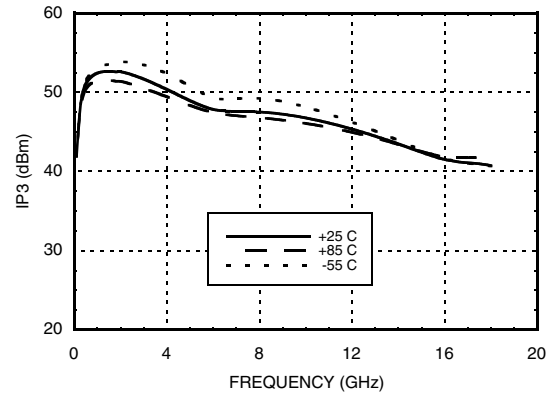

**Absolute Maximum Ratings**

RF Input Power	+30 dBm
Supply Voltage (Vdc)	+7 V
Control Voltage Range (Vctl)	-0.5V to Vdc +0.5V
Hot Switch Power Level	+27 dBm
Storage Temperature	-65 to +150 °C
Operating Temperature	-55 to +85 °C

**Control Voltages**

State	Bias Condition
High	+3.5 to Vdc @ 1 mA Typ.
Low	0 to +1.5V @ 20 µA Typ.



**ELECTROSTATIC SENSITIVE DEVICE  
OBSERVE HANDLING PRECAUTIONS**

**Truth Table**

Control Input	Signal Path State	
	RFC to RF1	RFC to RF2
High	On	Off
Low	Off	On

**Bias Voltage & Current**



Vdc Range = +5 Vdc ± 10%	
Vdc (V)	Idc (Typ.) (mA)
+5.0	1.4

(Bias current increases with switching rate to 15 - 20 mA.)

## GaAs MMIC SPDT NON-REFLECTIVE SWITCH, DC - 18 GHz

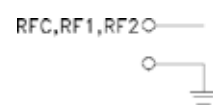

### Pin Descriptions

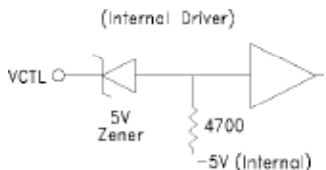
Pin Number	Function	Description	Interface Schematic
1, 2, 3	RFC, RF1, RF2	RF connector, SMA female, field replaceable. These pins are DC coupled and matched to 50 Ohms. DC blocking capacitors are required if external RF line potential is not equal to 0V.	
4	GND	Power supply ground.	
5	Vctl	CMOS interface, control voltages per table. Requires active pullup to +5V ( $V_{dc}$ ).	
6	Vdc	Supply voltage	

**GaAs MMIC SPDT NON-REFLECTIVE SWITCH, DC - 18 GHz**



**Outline Drawing**

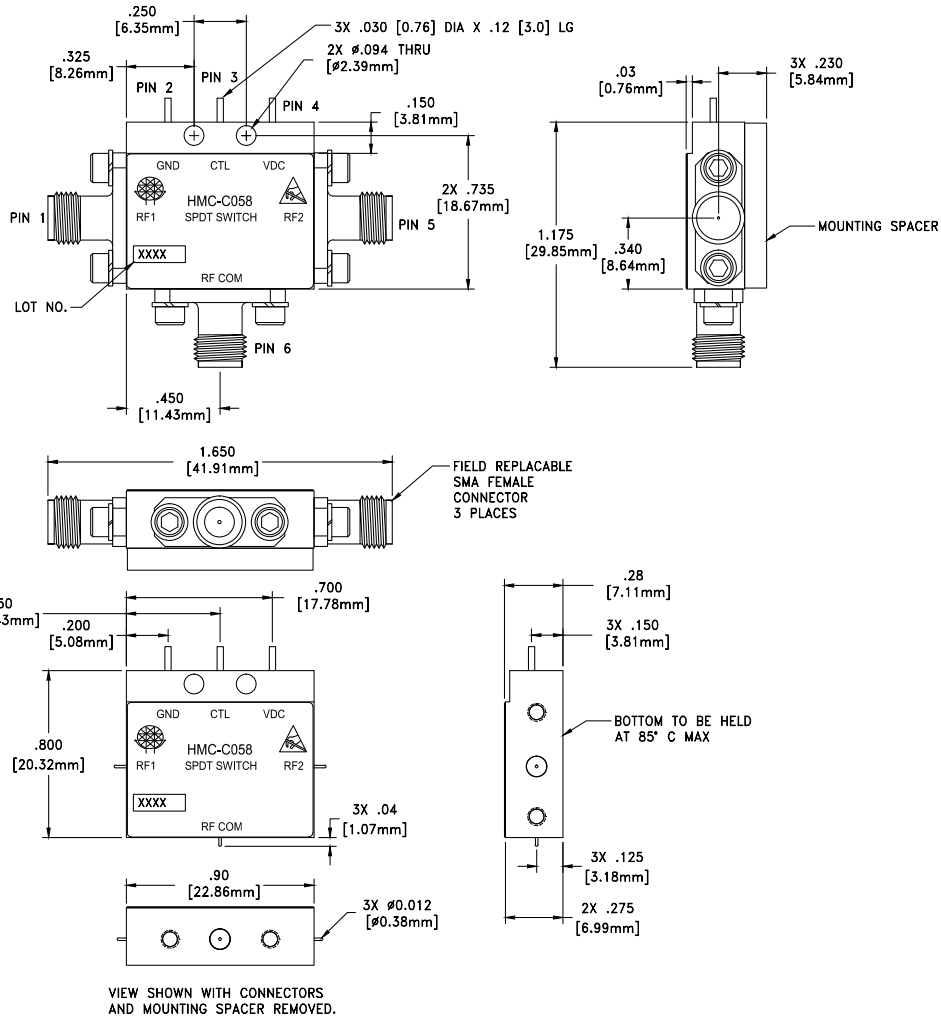

**Package Information**

Package Type	C-14
--------------	------

**NOTES:**

1. PACKAGE, LEADS, COVER MATERIAL: KOVAR™
2. PLATING: ELECTROLYTIC GOLD 50 MICROINCHES MIN., OVER ELECTROLYTIC NICKEL 75 MICROINCHES MIN.
3. SPACER MATERIAL: NICKEL PLATED ALUMINUM
4. DIMENSIONS ARE IN INCHES [MILLIMETERS].
5. TOLERANCES  $\pm$ 0.010 [0.25] UNLESS OTHERWISE SPECIFIED
6. FIELD REPLACEABLE SMA CONNECTORS. TENSOLITE 5602-5CCSF OR EQUIVALENT.

**GaAs MMIC SPDT NON-REFLECTIVE  
SWITCH, DC - 18 GHz****Notes:**