

REVISIONS					
REV	ECO	DESCRIPTION	DATE	BY	APPR
A1	-	RELEASE NEW DRAWING	05/APR/21	SULLEN	TOMMY

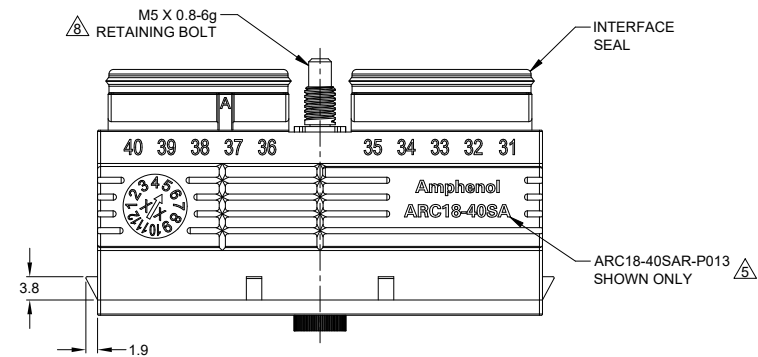
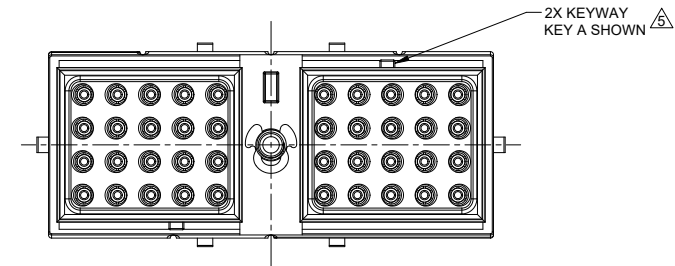
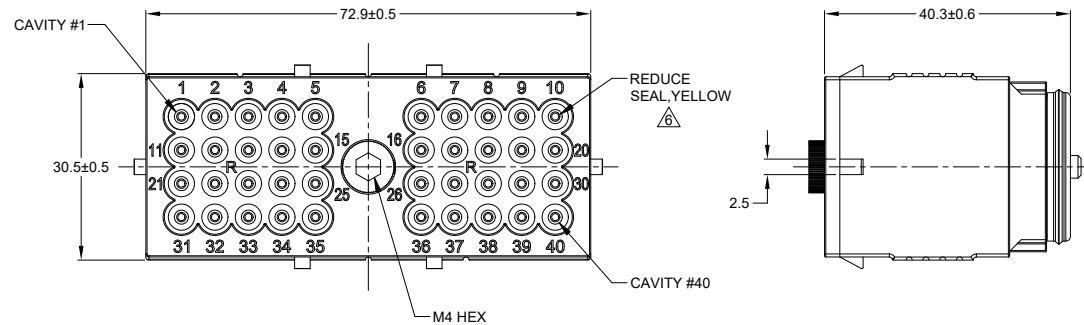

NOTES: UNLESS OTHERWISE SPECIFIED

- MATERIAL:
  - HOUSING: THERMOPLASTIC, BLACK
  - SEAL: SILICONE RUBBER
  - CLIP: STAINLESS STEEL
  - BOLD: STAINLESS STEEL
- MODIFICATIONS: REDUCE DIA. WIRE SEAL; INTERFACE SEALS ARE BONDED TO PLUG HOUSING
- SPECIFICATIONS:
  - 3.1 CURRENT RATING: 13 AMPS
  - 3.2 OPERATING TEMPERATURE: -55°C TO +125°C
  - 3.3 DIELECTRIC WITHSTANDING VOLTAGE: LESS THAN 2 MILLIAMPS CURRENT LEAKAGE @ 1500 VOLTS AC
  - 3.4 INSULATION RESISTANCE: 1000 MEGOHMS MIN @ 25°C
  - 3.5 MOISTURE RESISTANCE: IP68 ( IM OF WATER FOR A PERIOD OF 24 HOURS, MATED CONDITION ) IP69K( MATED CONDITION )
  - 3.6 MATING CYCLE DURABILITY: 100 CYCLES
  - 3.7 RoHS COMPLIANT
- MATING PART: ARC12-40PX\* RECEPTACLE ( X = A,B,C,D KEYS ; \* = ALL MODIFICATIONS)

SEE SHEET 2 FOR OTHER KEY ARRANGEMENTS

CONTACT SIZE AND REAR SEAL WIRE RANGE:

CONTACT SIZE	MIN. INSUL O.D.	MAX. INSUL O.D.	TYPICAL WIRE RANGE
16	1.35 mm (.053 in)	3.05 mm (.120 in)	14 - 20 AWG (2.0 - 0.5 mm <sup>2</sup> )

7. PLUG IS SUPPLIED WITH DUST CAP

8. MATING TORQUE REQUIREMENT: 25 - 28 IN-LB [ 2.82 - 3.16 Nm ]

9. ALL DIMENSIONS ARE FOR REFERENCE USE ONLY

TITLE: 40 POS. PLUG, SOCKET,ARC SERIES,KEYD, RD SEAL,BLACK  
 DWG NO: ARC18-40SXR-P013  
 REV: A1  
 SH: 1  
 OF: 2

SEE SHEET 2		DESCRIPTION		ITEM
QUANTITY	PART NUMBER	MATERIALS LIST		
<p>UNLESS OTHERWISE SPECIFIED</p> <p>1) All dimensions are in metric(mm).</p> <p>2) Tolerances are as follows:</p> <p>1 PL DEC ±0.30 Fractions ±1/64</p> <p>2 PL DEC ±0.15 Angles ±1°</p> <p>3 PL DEC ±0.08</p> <p>3) Note reference = </p>				
SIGNATURES		DATE		
DRAWN: SULLEN,ZHANG		05/APR/21		
CHECKED: ORION,LI		06/APR/21		
ENGINEER:				
APPROVAL: TOMMY,XIE		07/APR/21		
CUSTOMER:				
MATERIAL SPECIFICATIONS:		THIS DRAWING IS SUPPLIED FOR INFORMATION ONLY. DESIGN FEATURES, SPECIFICATIONS AND PERFORMANCE DATA SHOWN HEREON ARE THE PROPERTY OF THE AMPHENOL CORPORATION. NO RIGHTS OF REPRODUCTION ARE IMPLIED. ALL DIMENSIONS ARE SUBJECT TO NORMAL MANUFACTURING VARIATIONS.		
PROCESS SPECIFICATIONS:				
NEXT ASSY:				
SIZE		TYPE	DWG NO:	REVISION
B C-		ARC18-40SXR-P013	A1	
SCALE: NONE		SHEET 1 OF 2		

**Amphenol**

Sine Systems - www.amphenol-sine.com  
 44724 Morley Drive  
 Clinton Township, MI 48036

40 POS, PLUG, SOCKET,ARC SERIES,  
 KEYED, RD SEAL,BLACK

REVISIONS					
REV	ECO	DESCRIPTION	DATE	BY	APPR
A1	-	RELEASE NEW DRAWING	05/APR/21	SULLEN	TOMMY

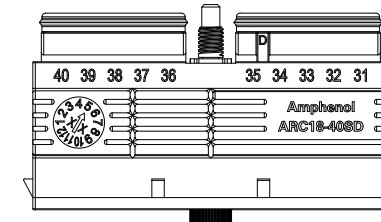
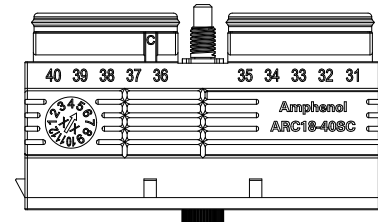
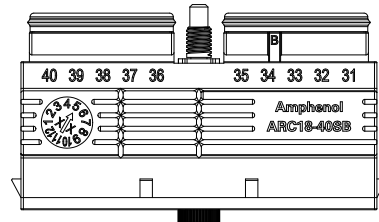
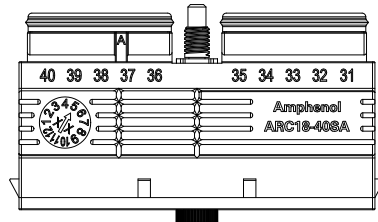
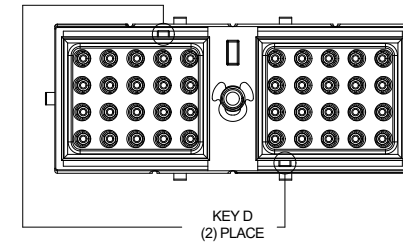
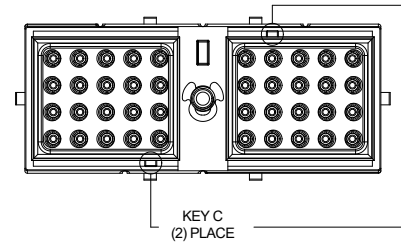
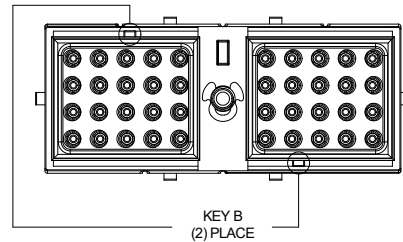
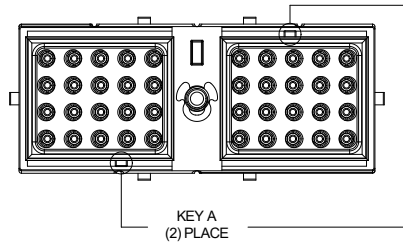

ARC18-40SXR-P013 VARIANTS	
PART NUMBER	REF
ARC18-40SAR-P013	DRC18-40SAE-P013

ARC18-40SXR-P013 VARIANTS	
PART NUMBER	REF
ARC18-40SBR-P013	DRC18-40SBE-P013

ARC18-40SXR-P013 VARIANTS	
PART NUMBER	REF
ARC18-40SCR-P013	DRC18-40SCE-P013

ARC18-40SXR-P013 VARIANTS	
PART NUMBER	REF
ARC18-40SDR-P013	DRC18-40SDE-P013

ARC18-40SXR-P013		DESCRIPTION		ITEM
QUANTITY	PART NUMBER	MATERIALS LIST		
<b>UNLESS OTHERWISE SPECIFIED</b> 1) All dimensions are in metric(mm). 2) Tolerances are as follows: 1 PL DEC ±0.30 2 PL DEC ±0.15 3 PL DEC ±0.08 Fractions ±1/64 Angles ±1° 3) Note reference =				
SIGNATURES		DATE		
DRAWN: SULLENZHANG		05/APR/21		
CHECKED: ORIONLI		06/APR/21		
ENGINEER:				
APPROVAL: TOMMY.XIE		07/APR/21		
CUSTOMER:				
MATERIAL SPECIFICATIONS:		THIS DRAWING IS SUPPLIED FOR INFORMATION ONLY. DESIGN FEATURES, SPECIFICATIONS AND PERFORMANCE DATA SHOWN HEREON ARE THE PROPERTY OF THE AMPHENOL CORPORATION. NO RIGHTS OF REPRODUCTION ARE IMPLIED. ALL DIMENSIONS ARE SUBJECT TO NORMAL MANUFACTURING VARIATIONS.		
PROCESS SPECIFICATIONS:				
NEXT ASSY:				
SIZE: <b>B C-</b> SCALE: NONE		DWG NO: <b>ARC18-40SXR-P013</b> REVISION: <b>A1</b>		SHEET 2 OF 2

TITLE: 40 POS. PLUG, SOCKET,ARC SERIES,KEYD, RD SEAL,BLACK  
 DWG NO: ARC18-40SXR-P013  
 REV: A1  
 SH: 2  
 OF: 2

# AT Series™ - Contact Size 16 Options

Machined Contacts, Sockets & Pins				
Part Number	Description	Size	AWG	Type
AT60-215-1631	Male Contact - Pin, Gold-plated	16	14	Machined
AT62-209-1631	Female Contact - Socket, Gold-plated	16	14	Machined
AT60-215-16141	Male Contact - Pin, Nickel-plated	16	14	Machined
AT62-209-16141	Female Contact - Socket, Nickel-plated	16	14	Machined
AT60-202-1631	Male Contact - Pin, Gold-plated	16	16-20	Machined
AT62-201-1631	Female Contact - Socket, Gold-plated	16	16-20	Machined
AT60-202-16141	Male Contact - Pin, Nickel-plated	16	16-20	Machined
AT62-201-16141	Female Contact - Socket, Nickel-plated	16	16-20	Machined
AT60-202-1631-22	Male Contact - Pin, Gold-plated	16	22-24	Machined
AT62-201-1631-22	Female Contact - Socket, Gold-plated	16	22-24	Machined
AT60-202-16141-22	Male Contact - Pin, Nickel-plated	16	22-24	Machined
AT62-201-16141-22	Female Contact - Socket, Nickel-plated	16	22-24	Machined

Tooling - Machined Contacts		
Part	Part Number	Description
	CA-5D12	Universal Hand Crimp Tool, Size 12/16/20 (Machined contacts only)
	CA-5E12	Pneumatic Crimp Tool, Size 12/16/20 (Machined contacts only)

Contact Removal Tools		
Part	Part Number	Description
	ATRT-100	Used for removal of contacts for A Series™ products
	AT11-310-1605	Contact Removal Tool, Plastic, Size 16
	A114017	Sealing Plug, Size 16, White

Stamped & Formed Contacts, Sockets & Pins				
Part Number	Description	Size	AWG	Type
AT60-14-0144	Male Contact - Pin, Gold-plated	16	14-16	Stamped & Formed
AT62-14-0144	Female Contact - Socket, Gold-plated	16	14-16	Stamped & Formed
AT60-14-0122	Male Contact - Pin, Nickel-plated	16	14-16	Stamped & Formed
AT62-14-0122	Female Contact - Socket, Nickel-plated	16	14-16	Stamped & Formed
AT60-16-0144	Male Contact - Pin, Gold-plated	16	16-18	Stamped & Formed
AT62-16-0144	Female Contact - Socket, Gold-plated	16	16-18	Stamped & Formed
AT60-16-0122	Male Contact - Pin, Nickel-plated	16	16-18	Stamped & Formed
AT62-16-0122	Female Contact - Socket, Nickel-plated	16	16-18	Stamped & Formed
AT60-16-0644	Male Contact - Pin, Gold-plated	16	18-20	Stamped & Formed
AT62-16-0644	Female Contact - Socket, Gold-plated	16	18-20	Stamped & Formed
AT60-16-0622	Male Contact - Pin, Nickel-plated	16	18-20	Stamped & Formed
AT62-16-0622	Female Contact - Socket, Nickel-plated	16	18-20	Stamped & Formed
AT60-16-0844	Male Contact - Pin, Gold-plated	16	20-22	Stamped & Formed
AT62-16-0844	Female Contact - Socket, Gold-plated	16	20-22	Stamped & Formed
AT60-16-0822	Male Contact - Pin, Nickel-plated	16	20-22	Stamped & Formed
AT62-16-0822	Female Contact - Socket, Nickel-plated	16	20-22	Stamped & Formed

Tooling - Stamped & Formed Contacts		
Part	Part Number	Description
	MFX-3950	Crimp Die - Size 16, 18-20AWG (S&F contacts only)
	MFX-3953	Crimp Die - Size 16, 16-18AWG (S&F contacts only)
	MFX-3975	Crimp Die - Size 16, 14-16AWG (S&F contacts only)
	MFX-3990	Crimp Die - Size 16, 20-22AWG (S&F contacts only)
	ATT-16-00	Hand Crimp Tool - Size 16, 14-16AWG (S&F contacts only)
	ATT-16-01	Hand Crimp Tool - Size 16, 18-20AWG (S&F contacts only)
	ATT-1612-03	Hand Crimp Tool - Size 16, 20-22AWG (S&F contacts only)

**Amphenol Sine Systems**  
 44724 Morley Drive  
 Clinton Township, MI 48036 USA  
[www.amphenol-sine.com](http://www.amphenol-sine.com)  
 09/2021