

TOLERANCE UNLESS OTHERWISE SPECIFIED	
.X	±0.25
.XX	±0.13
.XXX	±0.05

THIS IS A C.A.D. GENERATED DRAWING
DO NOT MAKE MANUAL REVISIONS TO MASTER.

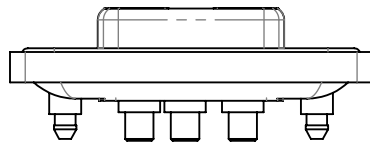

ISSUE NUMBER	
ORIGINAL	①

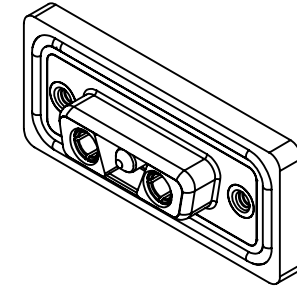
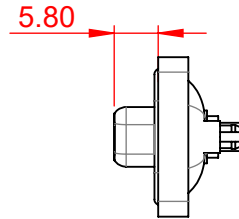
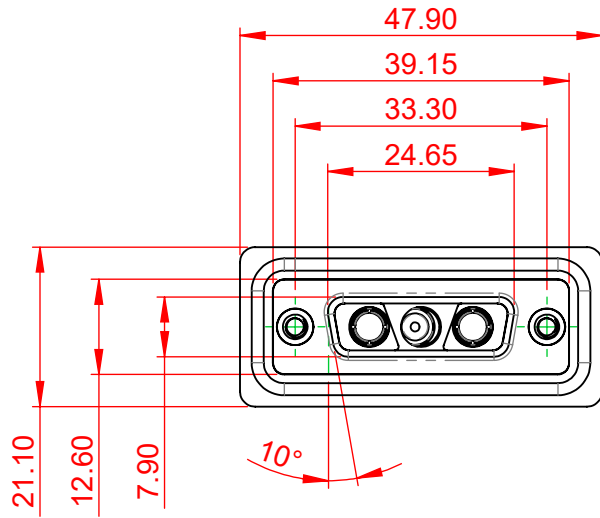

NOTES:

MATERIAL:

HOUSING: THERMOPLASTIC POLYESTER, UL94V-0

SHELL: STEEL, NICKEL PLATED

CONTACT: COPPER ALLOY, GOLD FLASH PLATING

OPERATING TEMPERATURE: -55°C ~ 125°C

SIGNAL CONTACT CURRENT RATING: 5A PER CONTACT

SIGNAL CONTACT RESISTANCE: 10mΩ MAX.

INSULATOR RESISTANCE: 5000MΩ min.

DIELECTRIC

WITHSTANDING VOLTAGE: 1000V AC rms



THIS SERIES FULLY CONFORMS TO
THE EUROPEAN UNION DIRECTIVES
2011/65/EU FOR RoHS COMPLIANCY.



YOUR CONNECTION TO QUALITY & SERVICE

EDAC INC
TORONTO, ONTARIO
CANADA

THESE DRAWINGS AND SPECIFICATIONS
ARE THE PROPERTY OF EDAC INC., AND
SHALL NOT BE REPRODUCED, OR COPIED
OR USED AS THE BASIS FOR THE
MANUFACTURE OR SALE OF APPARATUS
WITHOUT WRITTEN PERMISSION.

COMBINATION D-SUB

SW REFERENCE NO.: 628 COMBO ASSEMBLY	
DRAWN: C.B	DATE: JAN. 01/2019
CHECKED:	DATE:
SCALE: (IN C.A.D. 1:1)	SHEET 1 OF 4
DRAWING NUMBER: 628W3WK3224-4N5	ISSUE
PART NUMBER: 628W3WK3224-4N5	1

TOLERANCE UNLESS OTHERWISE SPECIFIED	
.X	±0.25
.XX	±0.13
.XXX	±0.05

THIS IS A C.A.D. GENERATED DRAWING
DO NOT MAKE MANUAL REVISIONS TO MASTER.



ISSUE NUMBER	
ORIGINAL	①



COMBINATION D-SUB		SW REFERENCE NO.: 628 COMBO ASSEMBLY	
		DRAWN: C.B	DATE: JAN. 01/2019
EDAC TORONTO, ONTARIO CANADA YOUR CONNECTION TO QUALITY & SERVICE		CHECKED:	DATE:
		SCALE: N.T.S	SHEET 2 OF 6
THESE DRAWINGS AND SPECIFICATIONS ARE THE PROPERTY OF EDAC INC., AND SHALL NOT BE REPRODUCED, OR COPIED OR USED AS THE BASIS FOR THE MANUFACTURE OR SALE OF APPARATUS WITHOUT WRITTEN PERMISSION.			DRAWING NUMBER: 628W3WK3224-4N5
			PART NUMBER: 628W3WK3224-4N5
			ISSUE 1



THIS SERIES FULLY CONFORMS TO
THE EUROPEAN UNION DIRECTIVES
2011/65/EU FOR RoHS COMPLIANCY.

TOLERANCE UNLESS OTHERWISE SPECIFIED	
.X	±0.25
.XX	±0.13
.XXX	±0.05

THIS IS A C.A.D. GENERATED DRAWING
DO NOT MAKE MANUAL REVISIONS TO MASTER.



ISSUE NUMBER	①
ORIGINAL	

2W2 / 2WK2



3W3 / 3WK3



5W1 Male/Female



24W7 Male/Female



5W5 Male



8W8 Male



7W2 Male/Female



21W4 Male/Female



5W5 Female



8W8 Female



11W1 Male/Female



27W2 Male/Female



CURRENT RATING / ϕ A

- 10A / 2.2
- 20A / 3.3
- 30A / 3.7
- 40A / 4.2

17W2 Male/Female



21W1 Male/Female



THIS SERIES FULLY CONFORMS TO
THE EUROPEAN UNION DIRECTIVES
2011/65/EU FOR RoHS COMPLIANCY.



YOUR CONNECTION TO QUALITY & SERVICE

COMBINATION D-SUB

EDAC INC
TORONTO, ONTARIO
CANADA

THESE DRAWINGS AND SPECIFICATIONS
ARE THE PROPERTY OF EDAC INC., AND
SHALL NOT BE REPRODUCED, OR COPIED
OR USED AS THE BASIS FOR THE
MANUFACTURE OR SALE OF APPARATUS
WITHOUT WRITTEN PERMISSION.

SW REFERENCE NO.: 628 COMBO ASSEMBLY	
DRAWN: C.B	DATE: JAN. 01/2019
CHECKED:	DATE:
SCALE: N.T.S	SHEET 3 OF 4
DRAWING NUMBER: 628W3WK3224-4N5	ISSUE 1
PART NUMBER: 628W3WK3224-4N5	

TOLERANCE UNLESS OTHERWISE SPECIFIED	
.X	±0.25
.XX	±0.13
.XXX	±0.05

THIS IS A C.A.D. GENERATED DRAWING
DO NOT MAKE MANUAL REVISIONS TO MASTER.



ISSUE NUMBER

ORIGINAL

1

9W4 Male



25W3 Male



9W4 Female



25W3 Female



13W3 Male



36W4 Male

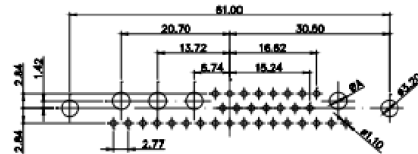

13W3 Female

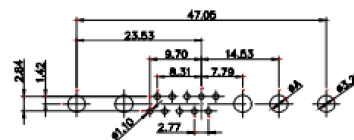

36W4 Female

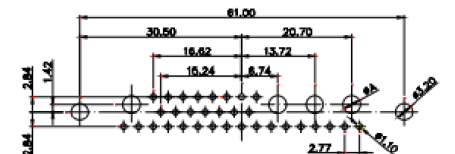

13W6 Male



43W2 Male



13W6 Female



43W2 Female



17W5 Male



47W1 Male



17W5 Female



47W1 Female



THIS SERIES FULLY CONFORMS TO
THE EUROPEAN UNION DIRECTIVES
2011/65/EU FOR RoHS COMPLIANCY.



YOUR CONNECTION TO QUALITY & SERVICE

COMBINATION D-SUB

EDAC INC
TORONTO, ONTARIO
CANADA

THESE DRAWINGS AND SPECIFICATIONS
ARE THE PROPERTY OF EDAC INC., AND
SHALL NOT BE REPRODUCED, OR COPIED
OR USED AS THE BASIS FOR THE
MANUFACTURE OR SALE OF APPARATUS
WITHOUT WRITTEN PERMISSION.

SW REFERENCE NO.: 628 COMBO ASSEMBLY	
DRAWN: C.B	DATE: JAN. 01/2019
CHECKED:	DATE:
SCALE: N.T.S	SHEET 4 OF 4
DRAWING NUMBER: 628W3WK3224-4N5	ISSUE 1
PART NUMBER: 628W3WK3224-4N5	