

OPA1637 Evaluation Module

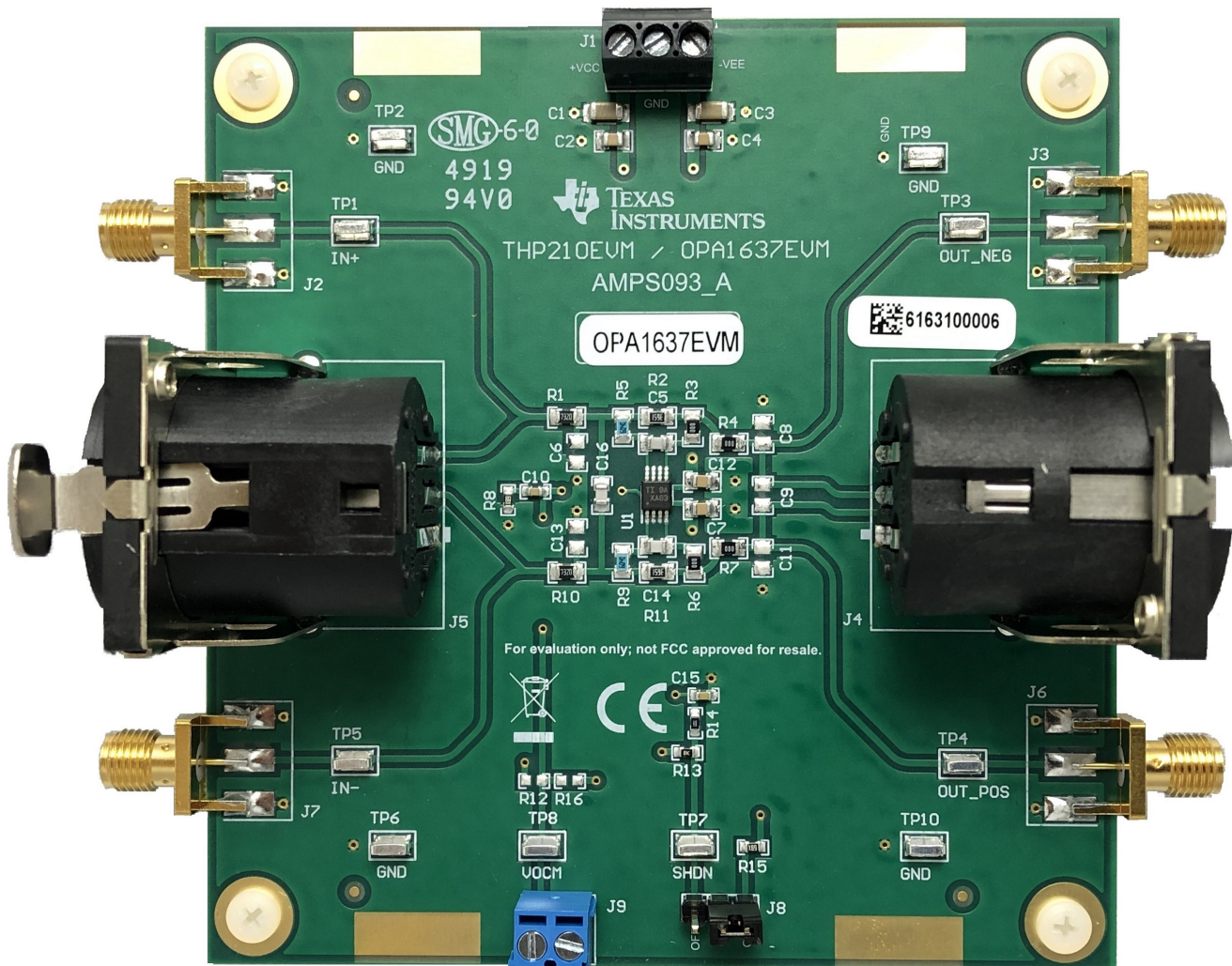

This user's guide contains information and support documentation for the OPA1637 evaluation module (EVM). Included are the circuit description, schematic, and bill of materials of the OPA1637EVM. Throughout this document, the terms evaluation board, evaluation module, and EVM are synonymous with the OPA1637EVM.

Contents

1	Introduction	3
1.1	Related Documentation	3
1.2	Electrostatic Discharge Caution.....	3
2	Schematic, PCB Layout, and Bill of Materials	4
2.1	Schematic.....	4
2.2	PCB Layout.....	4
2.3	Bill of Materials	10

List of Figures

1	OPA1637EVM Schematic	4
2	Top Overlay PCB Layout	5
3	Top Layer PCB Layout.....	6
4	Ground Layer PCB Layout	7
5	Power Layer PCB Layout.....	8
6	Bottom Layer PCB Layout.....	9

List of Tables

1	Related Documentation	3
2	OPA1637EVM Bill of Materials	10

Trademarks

Burr-Brown is a trademark of Texas Instruments.
All other trademarks are the property of their respective owners.

1 Introduction

The OPA1637 is a high-performance, low-noise, low total harmonic distortion (THD), fully differential amplifier that can easily filter and drive fully differential audio signal chains from Texas Instruments. For a full list of electrical characteristics, see the [OPA1637 High-Performance, High-Voltage, Low -Noise, Burr-Brown™ Fully Differential Amplifier data sheet](#).

The OPA1637EVM is configured by default in a second-order, low-pass, Butterworth filter configuration with a gain of 5-V/V and a corner frequency of 30-kHz. Input and output connections are accessible using SMA connectors and XLR audio connectors.

1.1 Related Documentation

The following document provides information regarding Texas Instruments integrated circuits used in the assembly of the OPA1637EVM. This user's guide is available from the TI website under literature number SBOU235. Any letter appended to the literature number corresponds to the document revision that is current at the time of the writing of this document. Newer revisions may be available from the TI website at <http://www.ti.com/>, or call the Texas Instruments Literature Response Center at (800) 477-8924 or the Product Information Center at (972) 644-5580. When ordering, identify the document by both title and literature number.

Table 1. Related Documentation

Device	Literature Number
OPA1637	SBOSA00

1.2 Electrostatic Discharge Caution

Many of the components on the OPA1637EVM are susceptible to damage by electrostatic discharge (ESD). Customers are advised to observe proper ESD handling precautions when unpacking and handling the EVM, including the use of a grounded wrist strap at an approved ESD workstation.

2 Schematic, PCB Layout, and Bill of Materials

This section contains the schematic, bill of materials, and pcb layout for the OPA1637EVM.

2.1 Schematic

Figure 1 illustrates the EVM schematic.

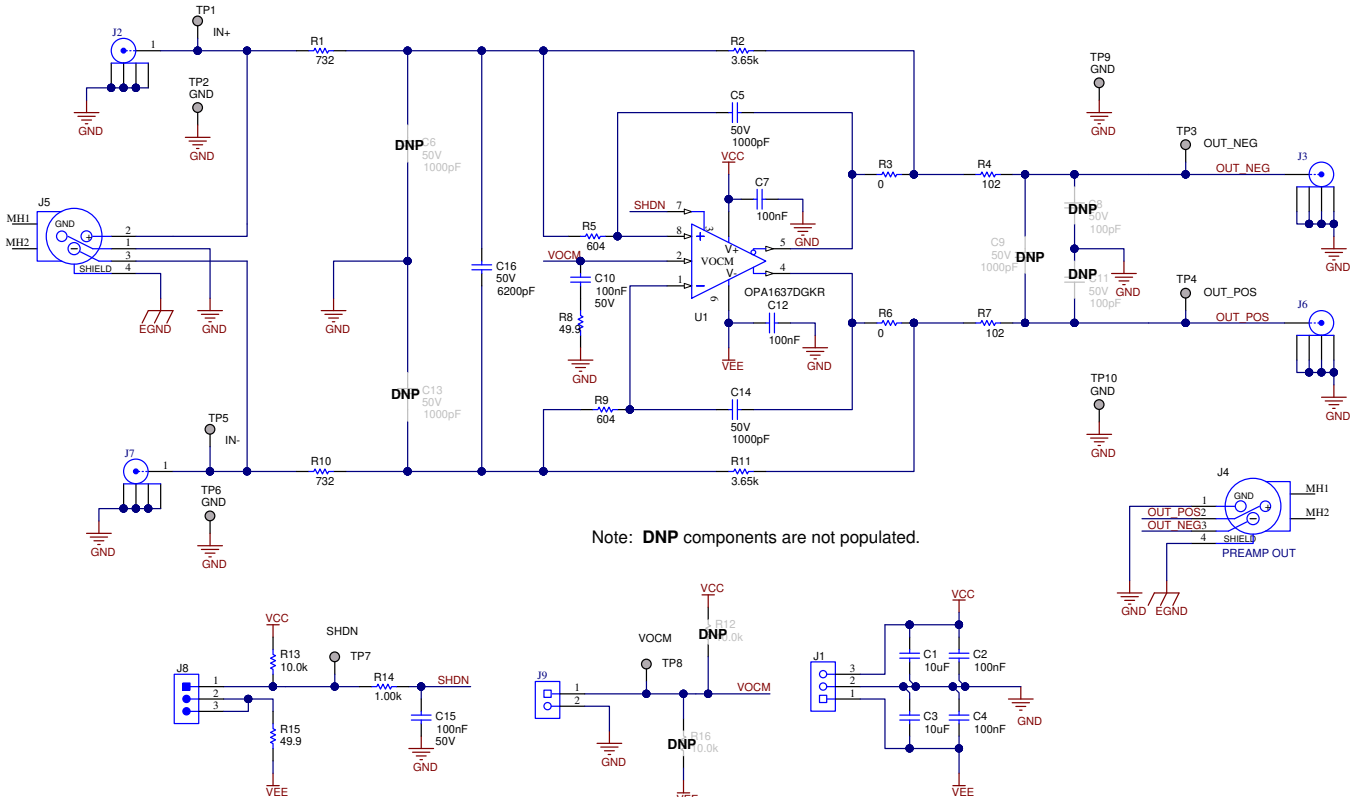

Figure 1. OPA1637EVM Schematic

2.2 PCB Layout

The OPA1637EVM is a four-layer PCB design. Figure 2 to Figure 6 show the PCB layer illustrations.

The top layer consists of all analog signal path traces, and is poured with a solid ground plane. To minimize second and other even-harmonic content, route traces as symmetrically as possible for both positive and negative feedback pathways. Place feedback components in close proximity to the output and input pins of the device. Position decoupling capacitors C7 and C12 on the top layer as close as possible to the power-supply pins.

The second internal layer is a dedicated solid GND plane. Place independent vias at the ground connection of every component to provide a low-impedance path to ground.

The third internal layer routes the power-supply connections.

The fourth layer routes the shutdown pin and VCOM pin connections.

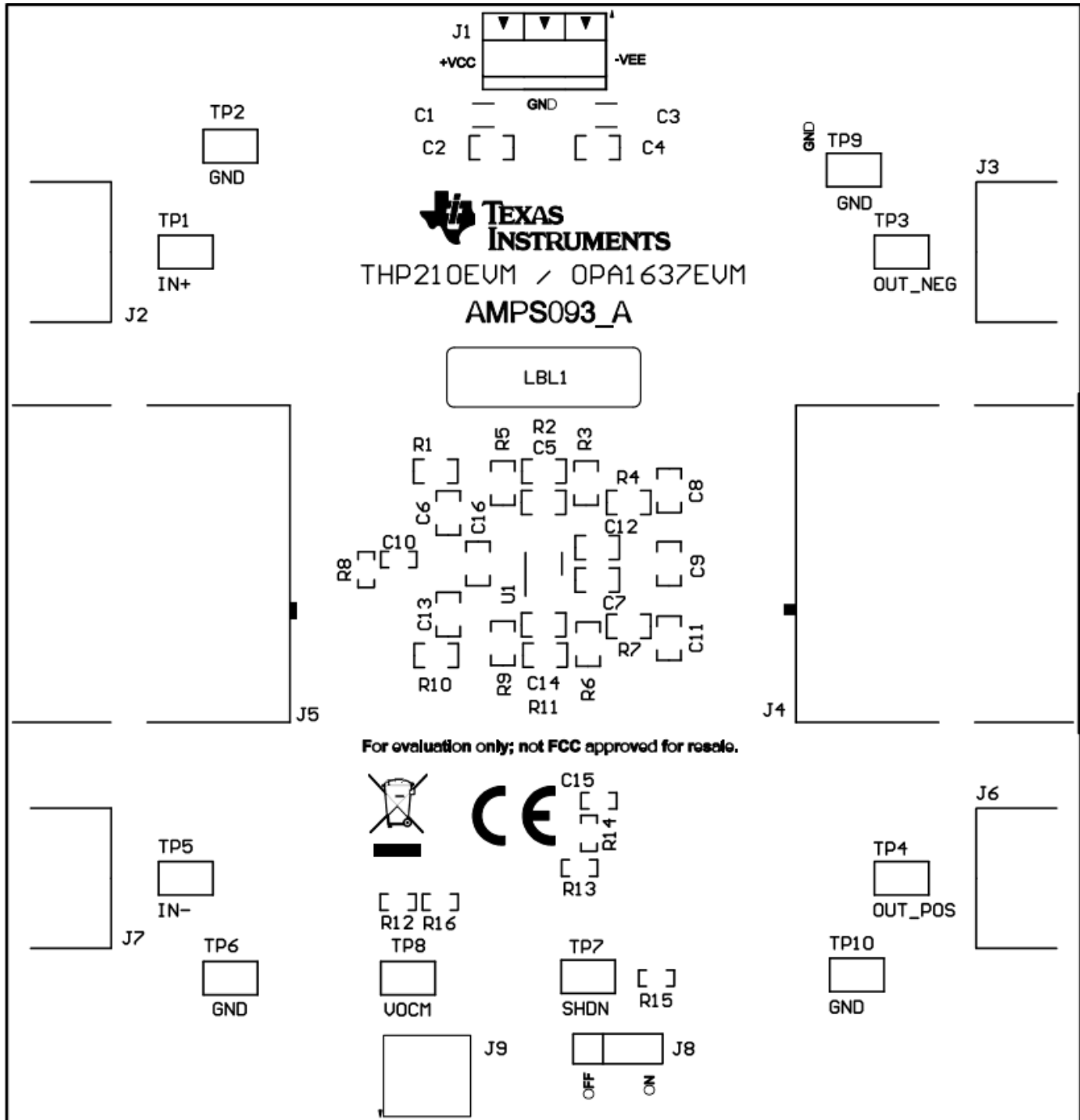

Figure 2. Top Overlay PCB Layout

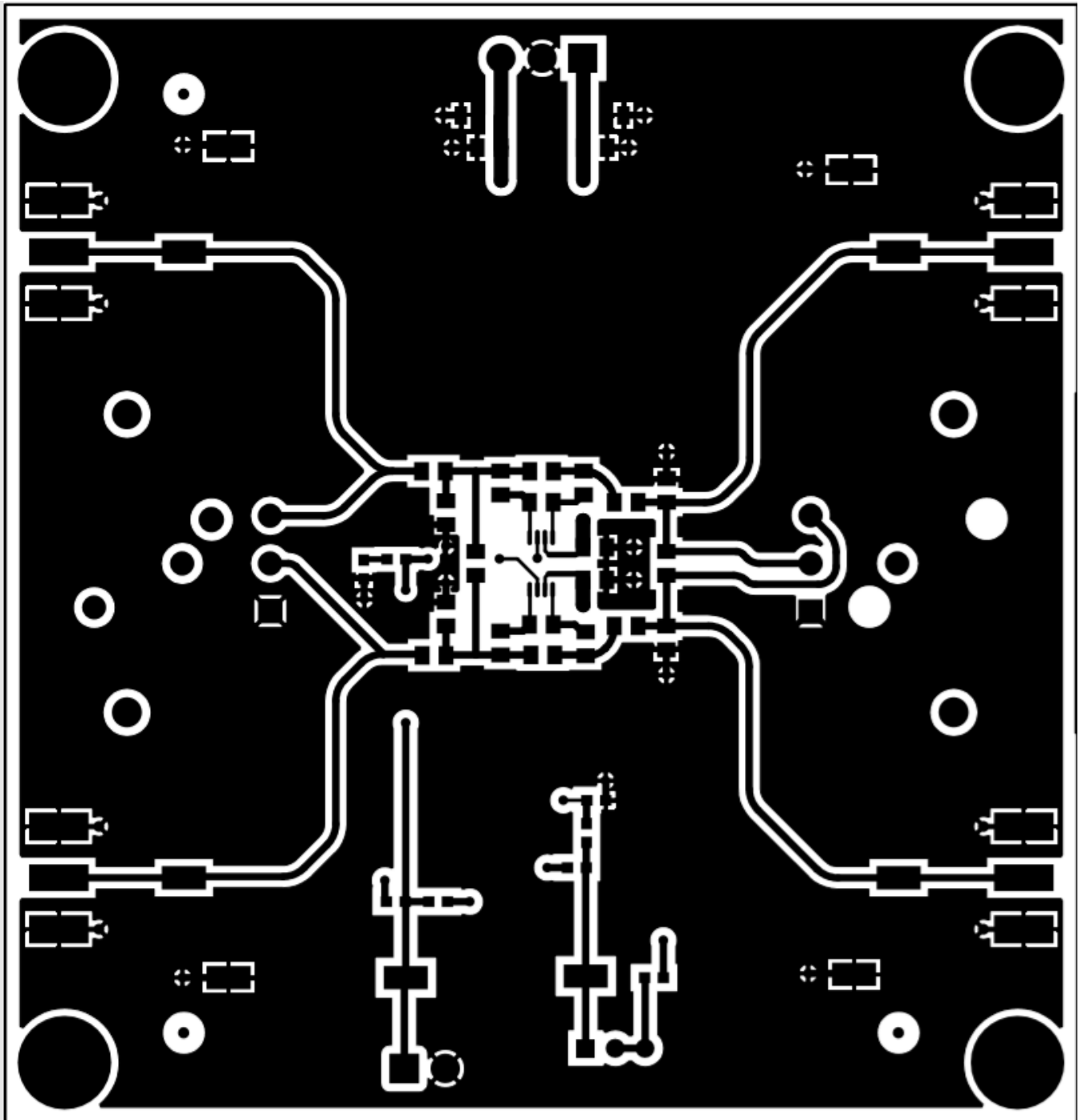

Figure 3. Top Layer PCB Layout

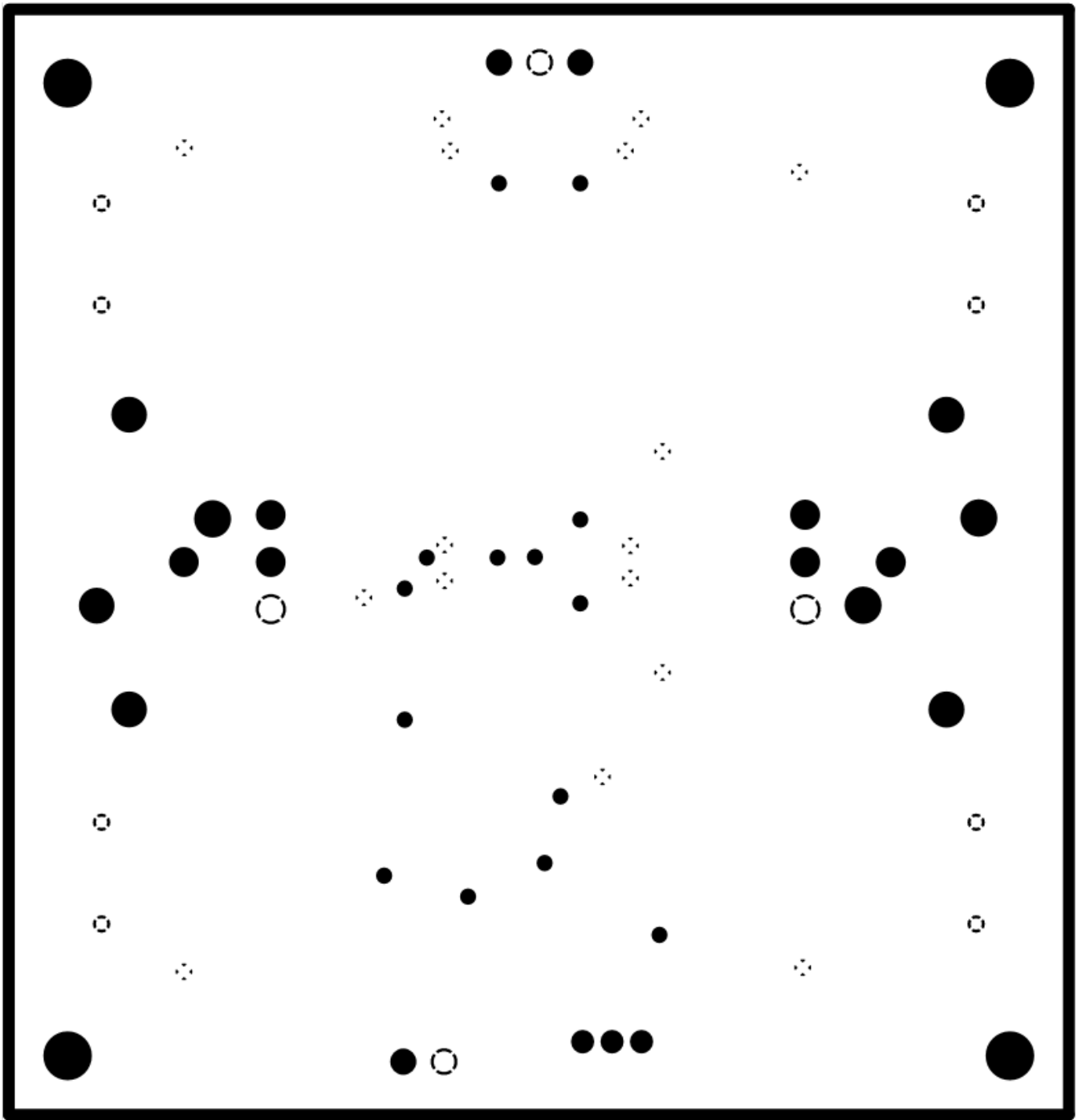

Figure 4. Ground Layer PCB Layout

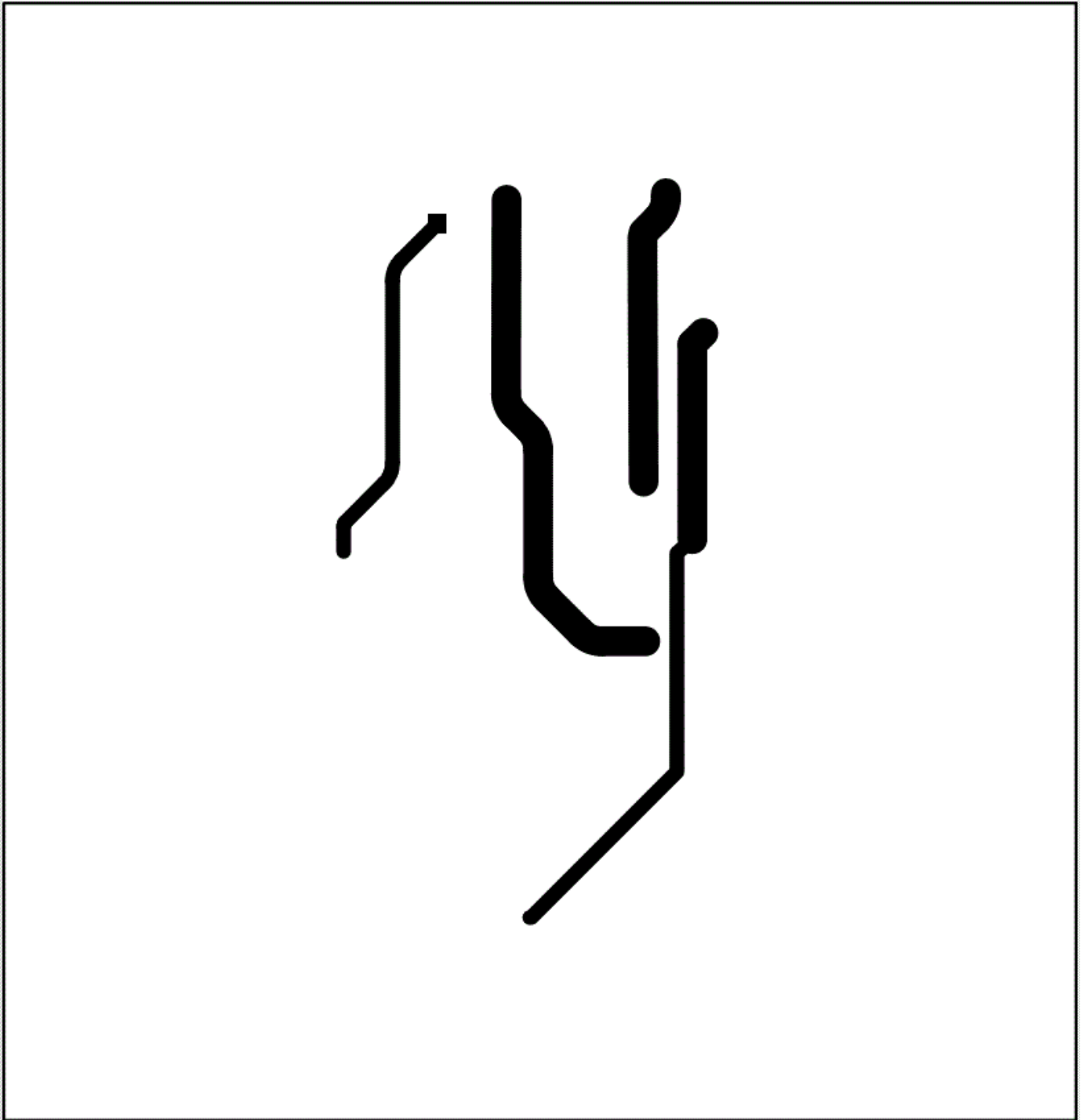

Figure 5. Power Layer PCB Layout

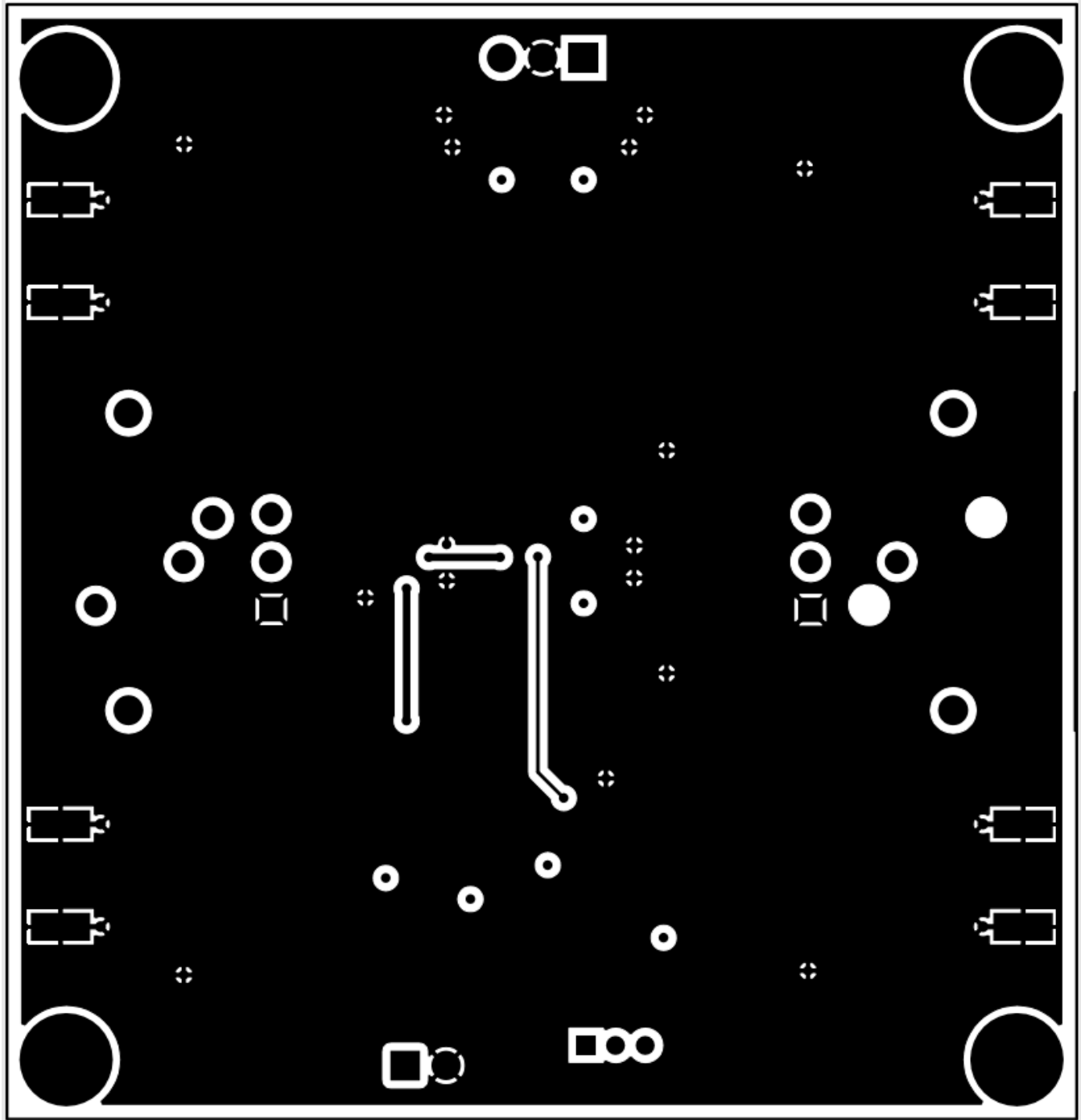

Figure 6. Bottom Layer PCB Layout

2.3 Bill of Materials

Table 2 lists the OPA1637EVM bill of materials (BOM).

Table 2. OPA1637EVM Bill of Materials

Designator	Qty	Value	Description	Package Reference	Part Number	Manufacturer
!PCB1	1		Printed Circuit Board		AMPS093	Any
C1, C3	2	10uF	CAP, CERM, 10 uF, 35 V, +/- 10%, X7R, 1206	1206	C3216X7R1V106K160AC	TDK
C2, C4, C7, C12	2	0.1uF	CAP, CERM, 0.1 uF, 50 V, +/- 10%, X7R, 0805	0805	08055C104KAT2A	AVX
C5, C14	2	1000pF	CAP, CERM, 1000 pF, 50 V, +/- 10%, CoG/NP0, 0805	0805	08055A102KAT2A	AVX
C10, C15	2	0.1uF	CAP, CERM, 0.1 uF, 50 V, +/- 5%, X7R, 0603	0603	C0603C104J5RACTU	Kemet
C16	1	6200pF	CAP, CERM, 6200 pF, 50 V, +/- 5%, CoG/NP0, 080	0805	GRM2195C1H622JA01D	MuRata
H1, H2, H3, H4	4		Machine Screw, Round, #4-40 x 1/4, Nylon, Philips panhead	Screw	NY PMS 440 0025 PH	B&F Fastener Supply
H5, H6, H7, H8	4		Standoff, Hex, 0.5"L #4-40 Nylon	Standoff	1902C	Keystone
J1	1		Terminal Block, 3.5mm Pitch, 3x1, TH	10.5x8.2x6.5mm	ED555/3DS	On-Shore Technology
J2, J3, J6, J7	4		Connector, End launch SMA, 50 ohm, SMT	End Launch SMA	142-0701-801	Cinch Connectivity
J4	1		Receptacle, Male, 3 Position, R/A, TH	Receptacle, Male, 3 Position, R/A, TH	PQG3MRA112	Switchcraft
J5	1		Receptacle, 160mil, 3 Position, R/A, TH	Receptacle, 160mil, 3 Position, R/A, TH	PQG3FRA112	Switchcraft
J8	1		Header, 100mil, 3x1, Gold, TH	PBC03SAAN	PBC03SAAN	Sullins Connector Solutions
J9	1		Terminal Block, 3.5mm Pitch, 2x1, TH	7.0x8.2x6.5mm	ED555/2DS	On-Shore Technology
R1, R10	2	732	RES, 732, 0.1%, 0.125 W, 0805	0805	RT0805BRD07732RL	Yageo America
R2, R11	2	3.65k	RES, 3.65 k, 1%, 0.125 W, AEC-Q200 Grade 0, 0805	0805	CRCW08053K65FKEA	Vishay-Dale
R3, R6	2	0	RES, 0, 0%, W, AEC-Q200 Grade 0, 0805	0805	PMR10EZPJ000	Rohm
R5, R9	2	604	RES, 604, 1%, 0.125 W, AEC-Q200 Grade 0, 0805	0805	CRCW0805604RFKEA	Vishay-Dale
R4, R7	2	102	RES, 102, 1%, 0.125 W, AEC-Q200 Grade 0, 0805	0805	CRCW0805102RFKEA	Vishay-Dale
R8, R15	2	49.9	RES, 49.9, 1%, 0.1 W, AEC-Q200 Grade 0, 0603	0603	CRCW060349R9FKEA	Vishay-Dale
R13	1	10.0k	RES, 10.0 k, 1%, 0.1 W, 0603	0603	ERJ-3EKF1002V	Panasonic
R14	1	1.00k	RES, 1.00 k, 1%, 0.1 W, AEC-Q200 Grade 0, 0603	0603	CRCW06031K00FKEA	Vishay-Dale
SH-J1	1	1x2	Shunt, 100mil, Flash Gold, Black	Closed Top 100mil Shunt	SPC02SYAN	Sullins Connector Solutions
TP1, TP2, TP3, TP4, TP5, TP6, TP7, TP8, TP9, TP10	10		Test Point, Miniature, SMT	Test Point, Miniature, SMT	5019	Keystone
U1	1		OPA1637, high voltage, low noise, low THD, fully differential amplifier	DGK0008A	OPA1637IDGKT	Texas Instruments

Revision History

NOTE: Page numbers for previous revisions may differ from page numbers in the current version.

Changes from Original (December 2019) to A Revision	Page
• Changed EVM image	1
• Changed R4/R7 to 102-Ohms	4
• Changed R4/R7 to 102-Ohms	10

IMPORTANT NOTICE AND DISCLAIMER

TI PROVIDES TECHNICAL AND RELIABILITY DATA (INCLUDING DATA SHEETS), DESIGN RESOURCES (INCLUDING REFERENCE DESIGNS), APPLICATION OR OTHER DESIGN ADVICE, WEB TOOLS, SAFETY INFORMATION, AND OTHER RESOURCES "AS IS" AND WITH ALL FAULTS, AND DISCLAIMS ALL WARRANTIES, EXPRESS AND IMPLIED, INCLUDING WITHOUT LIMITATION ANY IMPLIED WARRANTIES OF MERCHANTABILITY, FITNESS FOR A PARTICULAR PURPOSE OR NON-INFRINGEMENT OF THIRD PARTY INTELLECTUAL PROPERTY RIGHTS.

These resources are intended for skilled developers designing with TI products. You are solely responsible for (1) selecting the appropriate TI products for your application, (2) designing, validating and testing your application, and (3) ensuring your application meets applicable standards, and any other safety, security, regulatory or other requirements.

These resources are subject to change without notice. TI grants you permission to use these resources only for development of an application that uses the TI products described in the resource. Other reproduction and display of these resources is prohibited. No license is granted to any other TI intellectual property right or to any third party intellectual property right. TI disclaims responsibility for, and you will fully indemnify TI and its representatives against, any claims, damages, costs, losses, and liabilities arising out of your use of these resources.

TI's products are provided subject to [TI's Terms of Sale](#) or other applicable terms available either on ti.com or provided in conjunction with such TI products. TI's provision of these resources does not expand or otherwise alter TI's applicable warranties or warranty disclaimers for TI products.

TI objects to and rejects any additional or different terms you may have proposed.

Mailing Address: Texas Instruments, Post Office Box 655303, Dallas, Texas 75265
Copyright © 2022, Texas Instruments Incorporated