

Data sheet | Item number: 789-1341

Relay module; Nominal input voltage: 24 VDC; 1 changeover contact;
Limiting continuous current: 12 A; with manual operation; Red status
indicator; Module width: 18 mm; 2,50 mm²

www.wago.com/789-1341

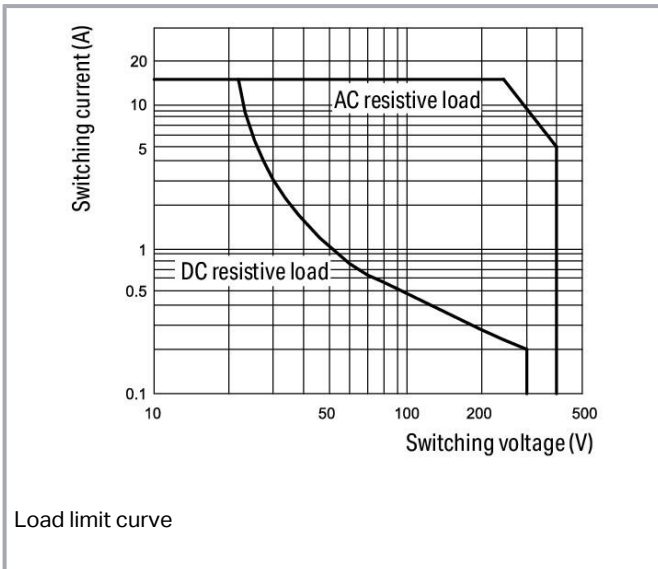
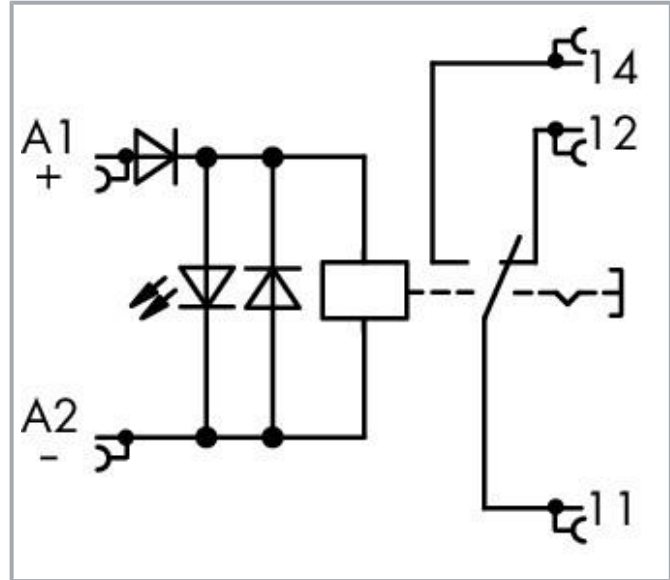

Data Notes

Note

Subject to changes. Please also observe the further product documentation!

WAGO GmbH & Co. KG
Hansastr. 27
32423 Minden
Phone: +49571 887-0 | Fax: +49571 887-169
Email: info.de@wago.com | Web: www.wago.com

Do you have any questions about our products?
We are always happy to take your call at +49 (571) 887-44222.



To protect the relay coils and contacts, inductive loads must be dampened with an effective protection circuit.

Technical data

Control Circuit

Nominal input voltage U_N	DC 24 V
Input voltage range	$\pm 10\%$
Nominal input current at U_N	17 mA

Load circuit

Number of changeover/switchover contacts	1
Contact material (relay)	AgNi
Limiting continuous current	12 A
Inrush current (resistive) max.	(AC) 30 A / 0.02 s; (AC) 24 A / 4 s
Switching voltage (max.)	AC 250 V
Switching power (resistive) max.	AC 3000 VA; DC (see load limit curve)
Recommended minimum load	12 V / 10 mA
Pull-in time (typ.)	15 ms
Drop-out time (typ.)	8 ms
Bounce time (typ.)	6 ms
Mechanical life	5×10^6 switching operations

Signaling

Status indicator	Red LED
------------------	---------

Safety and protection

Rated voltage	250 V
Rated surge voltage	4 kV
Pollution degree	2
Dielectric strength (control/load circuit) (AC, 1 min)	3.5 kVrms
Dielectric strength (open contact) (AC, 1 min)	1 kVrms
Protection type	IP20

Subject to changes. Please also observe the further product documentation!



Connection data

Connection technology	CAGE CLAMP®
Solid conductor	0.2 ... 2.5 mm ² / 24 ... 14 AWG
Fine-stranded conductor	0.2 ... 2.5 mm ² / 24 ... 14 AWG
Strip length	9 ... 10 mm / 0.35 ... 0.39 inches

Physical data

Width	17.5 mm / 0.689 inches
Height	90 mm / 3.543 inches
Depth from upper-edge of DIN-rail	55 mm / 2.165 inches

Mechanical data

Mounting type	DIN-35 rail
---------------	-------------

Material Data

Fire load	0.732 MJ
Weight	50.8 g

Environmental requirements

Ambient temperature (operation at U _N)	-25 ... +50 °C
Ambient temperature (storage)	-40 ... +70 °C
Processing temperature	-25 ... +50 °C

Standards and specifications

Standards/specifications	EN 60664-1
--------------------------	------------

Commercial data

Product Group	6 (INTERFACE ELECTRONIC)
eCl@ss 10.0	27-14-23-09
eCl@ss 9.0	27-14-23-09
ETIM 8.0	EC001437
ETIM 7.0	EC001437
PU (SPU)	10 (1) pcs
Packaging type	box
Country of origin	DE

Subject to changes. Please also observe the further product documentation!

GTIN	4050821386728
Customs tariff number	85364900990

Environmental Product Compliance

CAS-No.	7439-92-1 79-94-7
REACH Candidate List Substance	2,2',6,6'-tetrabromo-4,4'-isopropylidenediphenol Lead
RoHS Compliance Status	Compliant,With Exemption
RoHS Exemption	6(c) 7(a) 7(c)-I 7(c)-II
SCIP notification number (Bulgaria)	5cf6c72e-7f41-417b-b92d-3f6f266fbfee
SCIP notification number (Czech Republic)	08bfecbe-d802-4595-87a4-e46bf334dc13





Approvals / Certificates

General approvals











Logo	Approval	Additional Approval Text	Certificate name
	EAC Brjansker Zertifizierungsstelle	TP TC 004/2011	EAC RU C-DE.AM02. B.00122 /19

Optional accessories

Marking accessories

Marking devices			
	Item no.: 210-110 Fiber-tip pen		www.wago.com/210-110
Marker			
	Item no.: 2009-145 Mini-WSB Inline; for Smart Printer; 1700 pieces on roll; stretchable 5 - 5.2 mm; plain; snap-on type; white		www.wago.com/2009-145
	Item no.: 248-451 Mini-WSB marking card; as card; MARKED; K11 - K20 (10x); not stretchable; Horizontal marking; snap-on type; white		www.wago.com/248-451
	Item no.: 248-455 Mini-WSB marking card; as card; MARKED; U 100 (10x); not stretchable; Horizontal marking; snap-on type; white		www.wago.com/248-455

Subject to changes. Please also observe the further product documentation!

	Item no.: 248-450 Mini-WSB marking card; as card; MARKED; K1 - K10 (10x); not stretchable; Horizontal marking; snap-on type; white	www.wago.com/248-450
	Item no.: 248-452 Mini-WSB marking card; as card; MARKED; K (100x); not stretchable; Horizontal marking; snap-on type; white	www.wago.com/248-452
	Item no.: 248-453 Mini-WSB marking card; as card; MARKED; U1, ... U10 (10x); not stretchable; Horizontal marking; snap-on type; white	www.wago.com/248-453
	Item no.: 248-454 Mini-WSB marking card; as card; MARKED; U11 - U20 (10x); not stretchable; Horizontal marking; snap-on type; white	www.wago.com/248-454
	Item no.: 248-566 Mini-WSB marking card; as card; MARKED; 1 ... 50 (2x); not stretchable; Horizontal marking; snap-on type; white	www.wago.com/248-566
	Item no.: 248-501 Mini-WSB marking card; as card; not stretchable; plain; snap-on type; white	www.wago.com/248-501
	Item no.: 248-504 Mini-WSB marking card; as card; MARKED; 21 ... 30 (10x); not stretchable; Horizontal marking; snap-on type; white	www.wago.com/248-504
	Item no.: 248-503 Mini-WSB marking card; as card; MARKED; 11 ... 20 (10x); not stretchable; Horizontal marking; snap-on type; white	www.wago.com/248-503
	Item no.: 248-506 Mini-WSB marking card; as card; MARKED; 41 ... 50 (10x); not stretchable; Horizontal marking; snap-on type; white	www.wago.com/248-506
	Item no.: 248-502 Mini-WSB marking card; as card; MARKED; 1 ... 10 (10x); not stretchable; Horizontal marking; snap-on type; white	www.wago.com/248-502

Jumpers

Jumper

	Item no.: 789-112 Jumper; 12-way; silver-colored	www.wago.com/789-112
--	--	--

Tool

Operating tool

	Item no.: 210-720 Operating tool; Blade: 3.5 x 0.5 mm; with a partially insulated shaft; multicoloured	www.wago.com/210-720
--	--	--



Ferrule

Ferrule

	Item no.: 216-241 Ferrule; Sleeve for 0.5 mm ² / 20 AWG; insulated; electro-tin plated; electrolytic copper; gastight crimped; acc. to DIN 46228, Part 4/09.90; white	www.wago.com/216-241
---	--	--

Subject to changes. Please also observe the further product documentation!



	Item no.: 216-242 Ferrule; Sleeve for 0.75 mm ² / 18 AWG; insulated; electro-tin plated; electrolytic copper; gastight crimped; acc. to DIN 46228, Part 4/09.90; gray	www.wago.com/216-242
	Item no.: 216-243 Ferrule; Sleeve for 1 mm ² / AWG 18; insulated; electro-tin plated; electrolytic copper; gastight crimped; acc. to DIN 46228, Part 4/09.90; red	www.wago.com/216-243
	Item no.: 216-244 Ferrule; Sleeve for 1.5 mm ² / AWG 16; insulated; electro-tin plated; electrolytic copper; gastight crimped; acc. to DIN 46228, Part 4/09.90; black	www.wago.com/216-244

Downloads Documentation

Bid Text

789-1341 docx - Datei	2019 Feb 20	docx 17.2 kB	Download
789-1341 X81 - Datei	2019 Feb 19	xml 4.6 kB	Download

Instruction Leaflet

		pdf 1.3 MB	Download
--	--	---------------	----------

Additional Information

Disposal and Recycling Electrical and electronic equipment, Batteries, Packaging	V 1.1.0 2022 Aug 18	pdf 2.2 MB	Download
---	------------------------	---------------	----------

CAD/CAE-Data

CAE data

EPLAN Data Portal 789-1341		URL	Download
WSCAD Universe 789-1341		URL	Download
ZUKEN Portal 789-1341		URL	Download

CAD data

2D/3D Models 789-1341		URL	Download
-----------------------	--	-----	----------

Subject to changes. Please also observe the further product documentation!

Environmental Product Compliance

Compliance Search

Environmental Product Compliance 789-1341

[URL](#)

[Download](#)

Relay module; Nominal input voltage: 24 VDC; 1 changeover contact; Limiting continuous current: 12 A; with manual operation; Red status indicator; Module width: 18 mm; 2,50 mm²

Installation Notes

Conductor termination

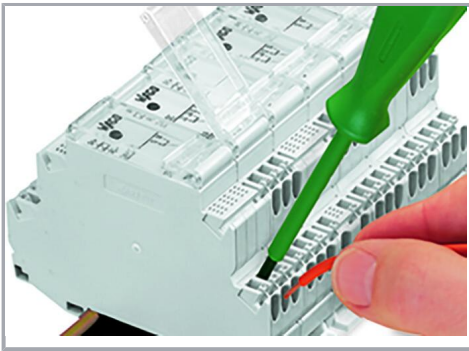

Inserting a conductor.

Commoning

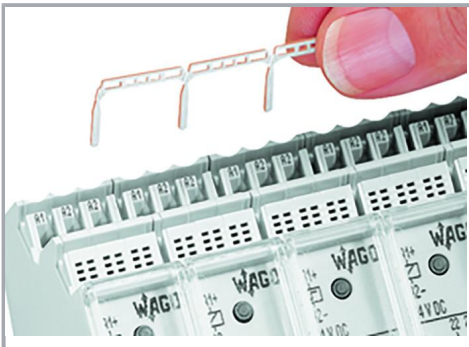

Easy commoning via adjacent jumpers.

Marking

Subject to changes. Please also observe the further product documentation!

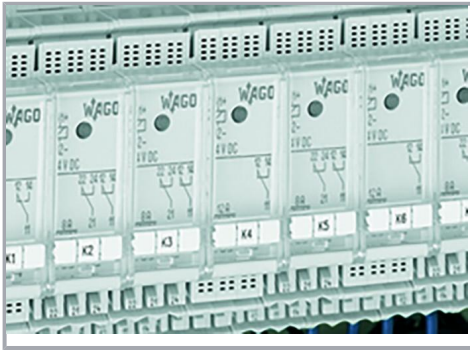

Marking via Mini-WSB Quick Marking System.

Subject to changes. Please also observe the further product documentation!

WAGO GmbH & Co. KG
Hansastr. 27
32423 Minden
Phone: +49571 887-0 | Fax: +49571 887-169
Email: info.de@wago.com | Web: www.wago.com

Do you have any questions about our products?
We are always happy to take your call at +49 (571) 887-44222.