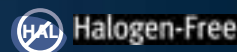


# EPC2100 – Enhancement-Mode GaN Power Transistor Half-Bridge

$V_{DS}$ , 30 V

$R_{DS(on)}$ , 8.2 mΩ (Q1), 2.1 mΩ (Q2)

$I_D$ , 10 A (Q1), 40 A (Q2)



Gallium Nitride's exceptionally high electron mobility and low temperature coefficient allows very low  $R_{DS(on)}$ , while its lateral device structure and majority carrier diode provide exceptionally low  $Q_G$  and zero  $Q_{RR}$ . The end result is a device that can handle tasks where very high switching frequency, and low on-time are beneficial as well as those where on-state losses dominate.

Maximum Ratings				
DEVICE	PARAMETER		UNIT	
Q1	$V_{DS}$	Drain-to-Source Voltage (Continuous)	30	V
		Drain-to-Source Voltage (up to 10,000 5 ms pulses at 150°C)	36	
	$I_D$	Continuous ( $T_A = 25^\circ\text{C}$ , $R_{\theta JA} = 92^\circ\text{C/W}$ )	10	A
		Pulsed ( $25^\circ\text{C}$ , $T_{PULSE} = 300 \mu\text{s}$ )	100	
	$V_{GS}$	Gate-to-Source Voltage	6	V
		Gate-to-Source Voltage	-4	
	$T_J$	Operating Temperature	-40 to 150	°C
$T_{STG}$	Storage Temperature	-40 to 150		
Q2	$V_{DS}$	Drain-to-Source Voltage (Continuous)	30	V
		Drain-to-Source Voltage (up to 10,000 5 ms pulses at 150°C)	36	
	$I_D$	Continuous ( $T_A = 25^\circ\text{C}$ , $R_{\theta JA} = 22^\circ\text{C/W}$ )	40	A
		Pulsed ( $25^\circ\text{C}$ , $T_{PULSE} = 300 \mu\text{s}$ )	400	
	$V_{GS}$	Gate-to-Source Voltage	6	V
		Gate-to-Source Voltage	-4	
	$T_J$	Operating Temperature	-40 to 150	°C
$T_{STG}$	Storage Temperature	-40 to 150		

Thermal Characteristics ( $T_J = 25^\circ\text{C}$ unless otherwise stated)			
PARAMETER		TYP	UNIT
$R_{\theta JC}$	Thermal Resistance, Junction-to-Case	0.4	°C/W
$R_{\theta JB}$	Thermal Resistance, Junction-to-Board	2.5	
$R_{\theta JA}$	Thermal Resistance, Junction-to-Ambient (Note 1)	42	

Note 1:  $R_{\theta JA}$  is determined with the device mounted on one square inch of copper pad, single layer 2 oz copper on FR4 board. See [https://epc-co.com/epc/documents/product-training/Appnote\\_Thermal\\_Performance\\_of\\_eGaN\\_FETs.pdf](https://epc-co.com/epc/documents/product-training/Appnote_Thermal_Performance_of_eGaN_FETs.pdf) for details



EPC2100 eGaN® ICs are supplied only in passivated die form with solder bumps  
Die Size: 6.05 mm x 2.3 mm

### Applications

- High Frequency DC-DC
- Point-of-Load (POL) Converters

### Benefits

- High Frequency Operation
- Ultra High Efficiency
- High Density Footprint

Static Characteristics ( $T_J = 25^\circ\text{C}$  unless otherwise stated)

DEVICE	PARAMETER		TEST CONDITIONS	MIN	TYP	MAX	UNIT
Q1	$BV_{DSS}$	Drain-to-Source Voltage	$V_{GS} = 0\text{ V}, I_D = 0.3\text{ mA}$	30			V
	$I_{DSS}$	Drain-Source Leakage	$V_{DS} = 24\text{ V}, V_{GS} = 0\text{ V}$		0.004	0.2	mA
	$I_{GSS}$	Gate-to-Source Forward Leakage	$V_{GS} = 5\text{ V}$		0.007	3	mA
		Gate-to-Source Reverse Leakage	$V_{GS} = -4\text{ V}$		0.004	0.2	mA
	$V_{GS(TH)}$	Gate Threshold Voltage	$V_{DS} = V_{GS}, I_D = 4\text{ mA}$	0.8	1.3	2.5	V
	$R_{DS(on)}$	Drain-Source On Resistance	$V_{GS} = 5\text{ V}, I_D = 25\text{ A}$		6	8.2	m $\Omega$
	$V_{SD}$	Source-Drain Forward Voltage	$I_S = 0.5\text{ A}, V_{GS} = 0\text{ V}$		1.8		V
Q2	$BV_{DSS}$	Drain-to-Source Voltage	$V_{GS} = 0\text{ V}, I_D = 1\text{ mA}$	30			V
	$I_{DSS}$	Drain-Source Leakage	$V_{DS} = 24\text{ V}, V_{GS} = 0\text{ V}$		0.015	0.8	mA
	$I_{GSS}$	Gate-to-Source Forward Leakage	$V_{GS} = 5\text{ V}$		0.03	9	mA
		Gate-to-Source Reverse Leakage	$V_{GS} = -4\text{ V}$		0.015	0.8	mA
	$V_{GS(TH)}$	Gate Threshold Voltage	$V_{DS} = V_{GS}, I_D = 16\text{ mA}$	0.8	1.3	2.5	V
	$R_{DS(on)}$	Drain-Source On Resistance	$V_{GS} = 5\text{ V}, I_D = 25\text{ A}$		1.5	2.1	m $\Omega$
	$V_{SD}$	Source-Drain Forward Voltage	$I_S = 0.5\text{ A}, V_{GS} = 0\text{ V}$		1.7		V

## Dynamic Characteristics

DEVICE	PARAMETER		TEST CONDITIONS	MIN	TYP	MAX	UNIT
Q1	$C_{ISS}$	Input Capacitance	$V_{DS} = 15\text{ V}, V_{GS} = 0\text{ V}$		395	475	pF
	$C_{RSS}$	Reverse Transfer Capacitance			15		
	$C_{OSS}$	Output Capacitance			290	435	
	$C_{OSS(ER)}$	Effective Output Capacitance, Energy Related (Note 2)	$V_{DS} = 0\text{ to }15\text{ V}, V_{GS} = 0\text{ V}$		371		
	$C_{OSS(TR)}$	Effective Output Capacitance, Time Related (Note 3)			404		
	$Q_G$	Total Gate Charge	$V_{DS} = 15\text{ V}, V_{GS} = 5\text{ V}, I_D = 25\text{ A}$		3.6	4.9	nC
	$Q_{GS}$	Gate-to-Source Charge	$V_{DS} = 15\text{ V}, I_D = 25\text{ A}$		1.3		
	$Q_{GD}$	Gate-to-Drain Charge			0.6		
	$Q_{G(TH)}$	Gate Charge at Threshold			0.9		
	$Q_{OSS}$	Output Charge	$V_{DS} = 15\text{ V}, V_{GS} = 0\text{ V}$		6.1	9.2	
	$Q_{RR}$	Source-Drain Recovery Charge			0		
Q2	$C_{ISS}$	Input Capacitance	$V_{DS} = 15\text{ V}, V_{GS} = 0\text{ V}$		1630	1960	pF
	$C_{RSS}$	Reverse Transfer Capacitance			64		
	$C_{OSS}$	Output Capacitance			1370	2060	
	$C_{OSS(ER)}$	Effective Output Capacitance, Energy Related (Note 2)	$V_{DS} = 0\text{ to }15\text{ V}, V_{GS} = 0\text{ V}$		1740		
	$C_{OSS(TR)}$	Effective Output Capacitance, Time Related (Note 3)			1900		
	$Q_G$	Total Gate Charge	$V_{DS} = 15\text{ V}, V_{GS} = 5\text{ V}, I_D = 25\text{ A}$		15	19	nC
	$Q_{GS}$	Gate-to-Source Charge	$V_{DS} = 15\text{ V}, I_D = 25\text{ A}$		4.8		
	$Q_{GD}$	Gate-to-Drain Charge			2.7		
	$Q_{G(TH)}$	Gate Charge at Threshold			3.4		
	$Q_{OSS}$	Output Charge	$V_{DS} = 15\text{ V}, V_{GS} = 0\text{ V}$		29	44	
	$Q_{RR}$	Source-Drain Recovery Charge			0		

Note 2:  $C_{OSS(ER)}$  is a fixed capacitance that gives the same stored energy as  $C_{OSS}$  while  $V_{DS}$  is rising from 0 to 50%  $BV_{DSS}$ .

Note 3:  $C_{OSS(TR)}$  is a fixed capacitance that gives the same charging time as  $C_{OSS}$  while  $V_{DS}$  is rising from 0 to 50%  $BV_{DSS}$ .

Figure 1a (Q1): Typical Output Characteristics at 25°C

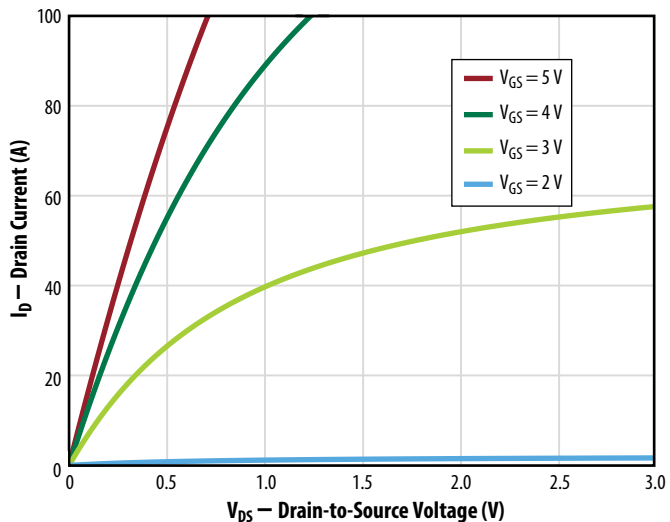


Figure 1b (Q2): Typical Output Characteristics at 25°C

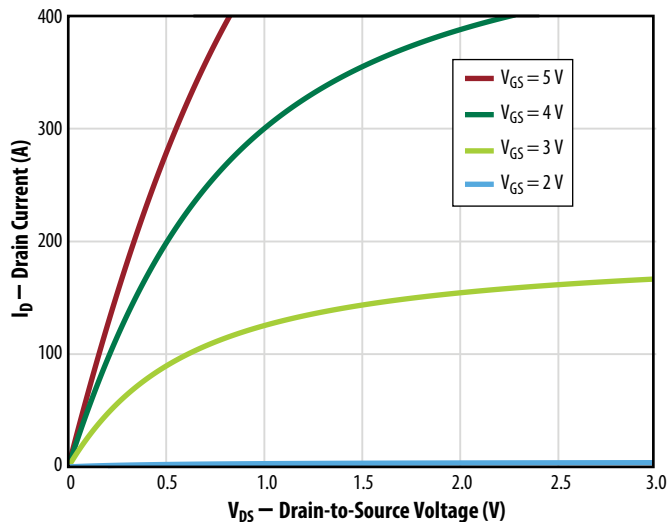


Figure 2a (Q1): Transfer Characteristics

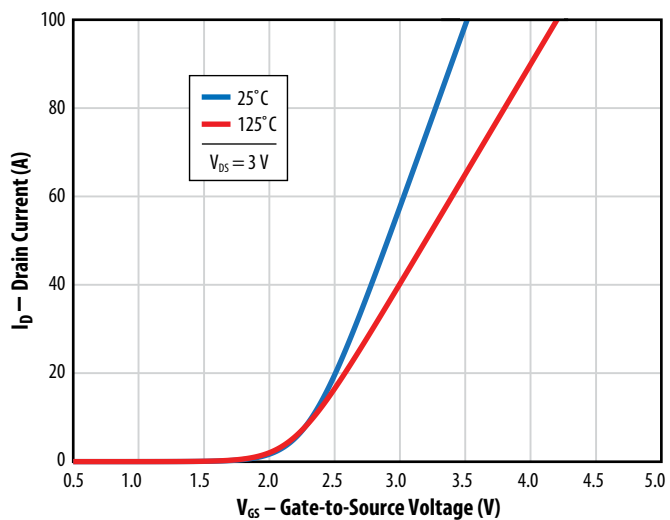


Figure 2b (Q2): Transfer Characteristics

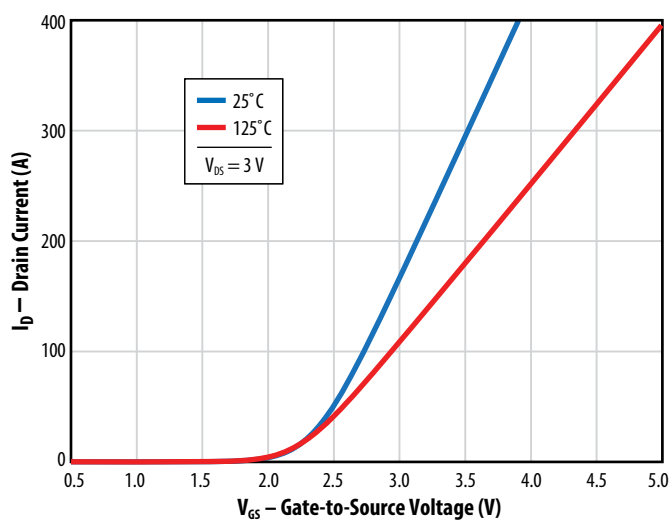


Figure 3a (Q1):  $R_{DS(on)}$  vs.  $V_{GS}$  for Various Drain Currents

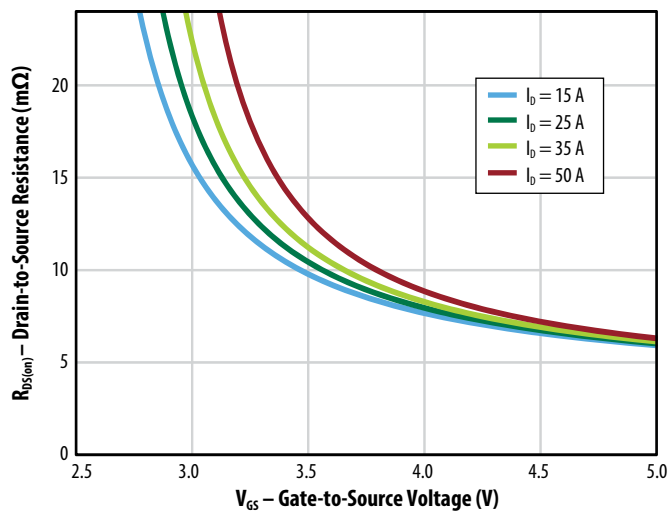


Figure 3b (Q2):  $R_{DS(on)}$  vs.  $V_{GS}$  for Various Drain Currents

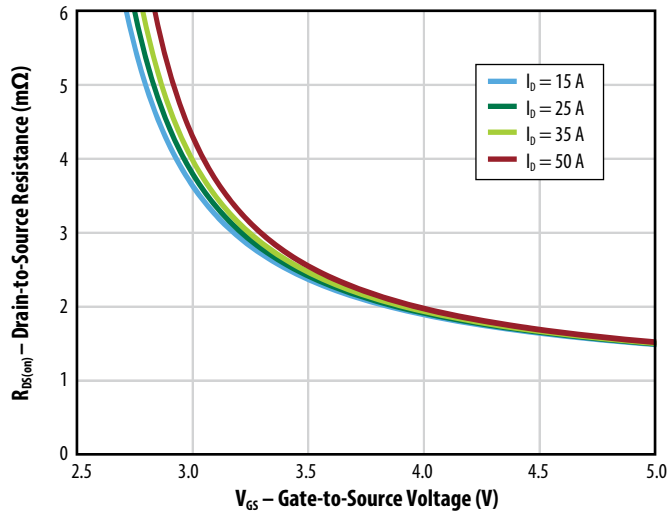


Figure 4a (Q1):  $R_{DS(on)}$  vs.  $V_{GS}$  for Various Temperatures

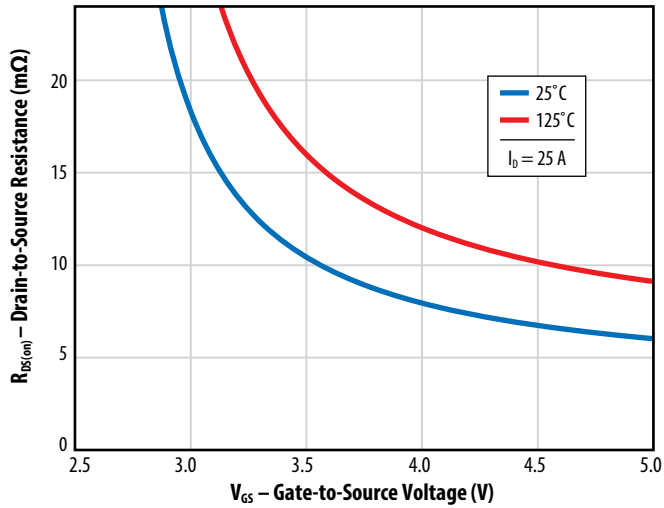


Figure 4b (Q2):  $R_{DS(on)}$  vs.  $V_{GS}$  for Various Temperatures

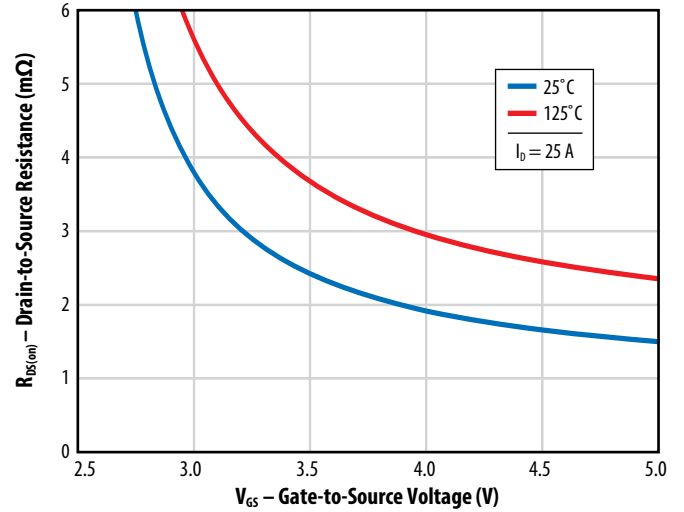


Figure 5a (Q1): Capacitance (Linear Scale)

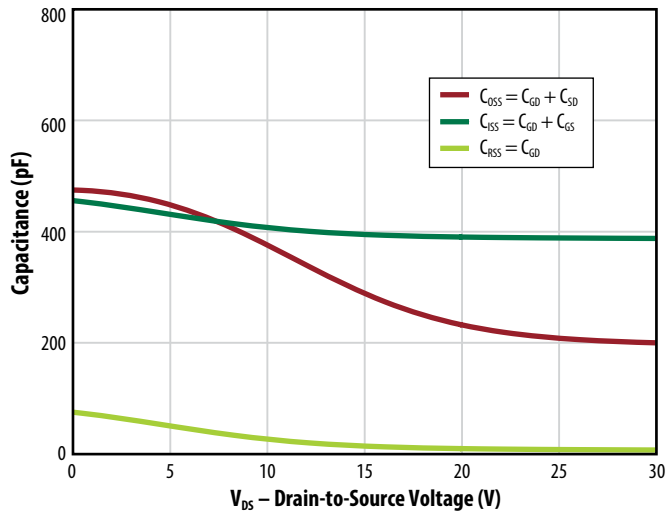


Figure 5b (Q1): Capacitance (Log Scale)

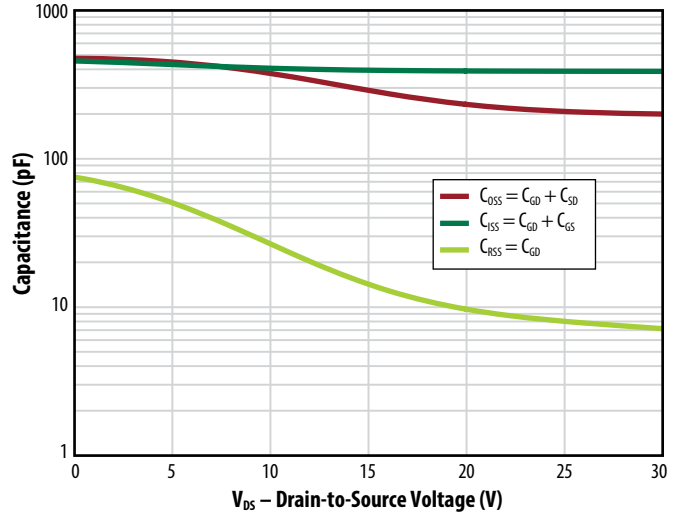


Figure 5c (Q2): Capacitance (Linear Scale)

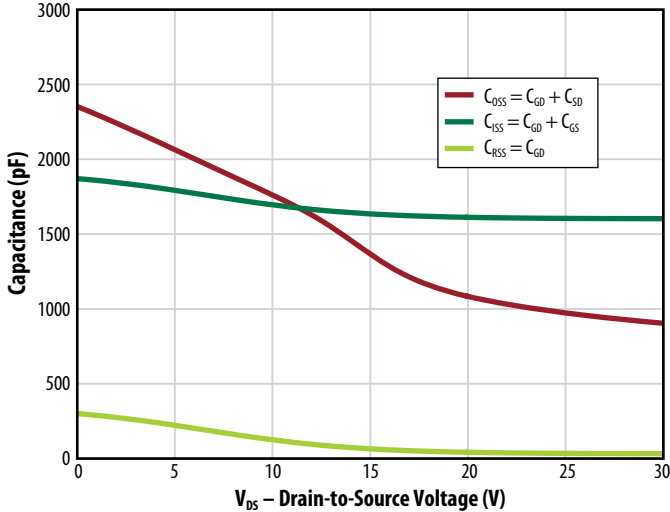


Figure 5d (Q2): Capacitance (Log Scale)

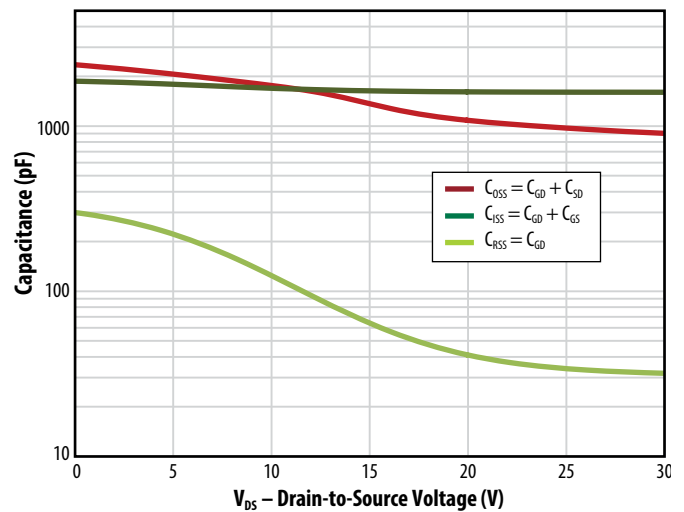


Figure 6a (Q1): Output Charge and  $C_{OSS}$  Stored Energy

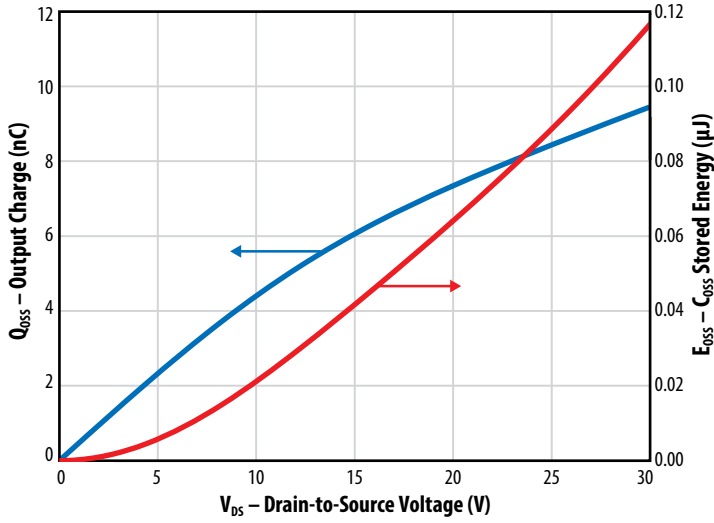


Figure 6b (Q2): Output Charge and  $C_{OSS}$  Stored Energy

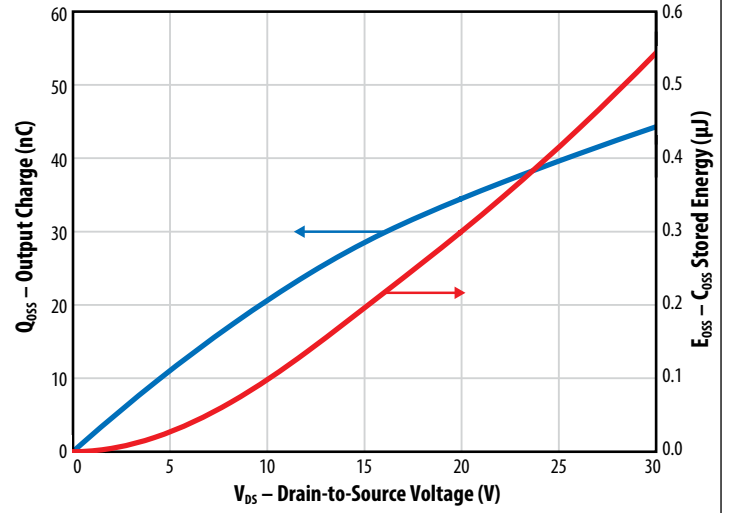


Figure 7a (Q1): Gate Charge

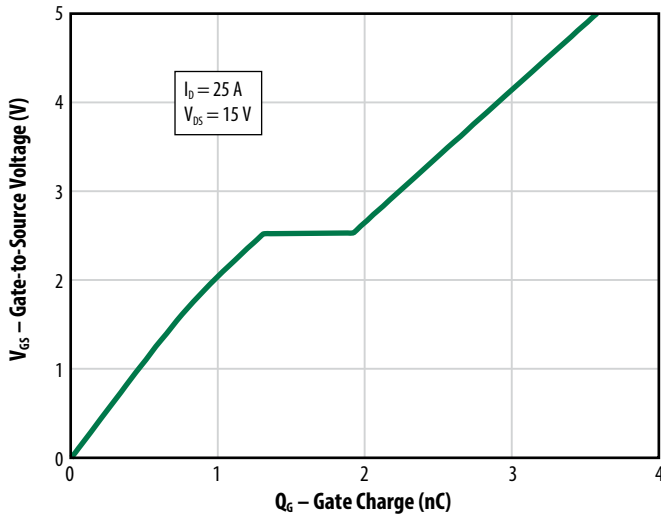


Figure 7b (Q2): Gate Charge

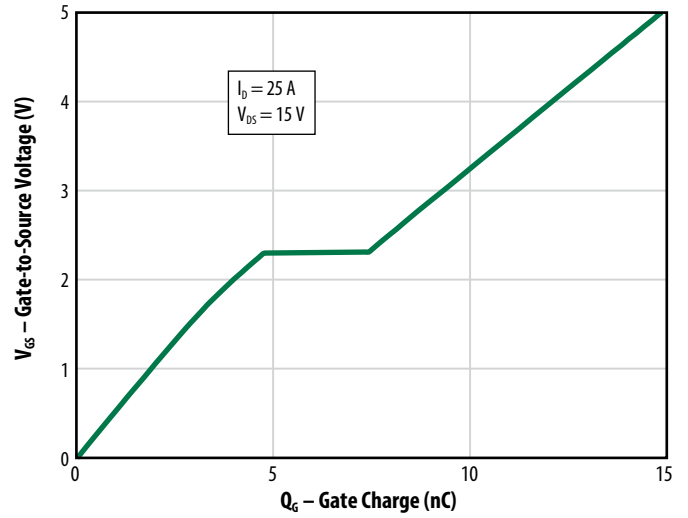


Figure 8a (Q1): Reverse Drain-Source Characteristics

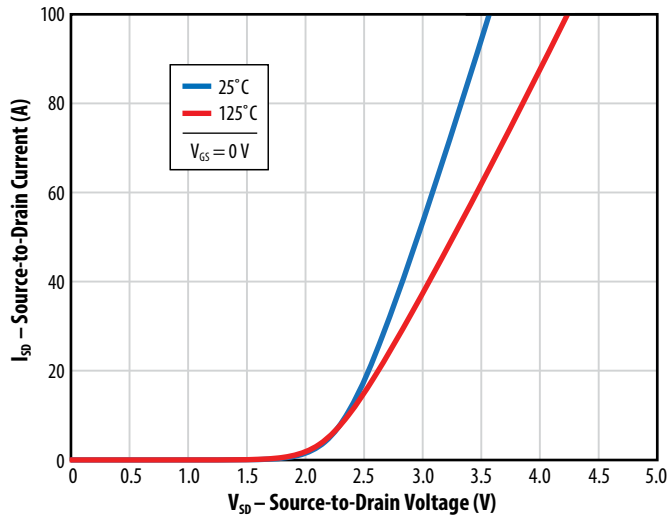
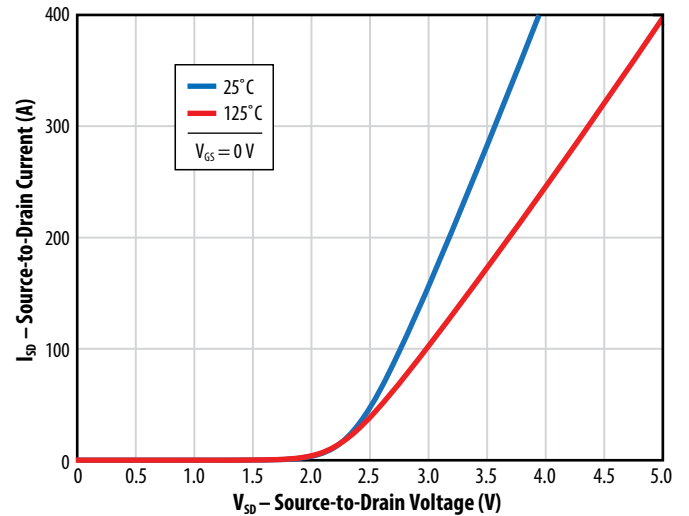
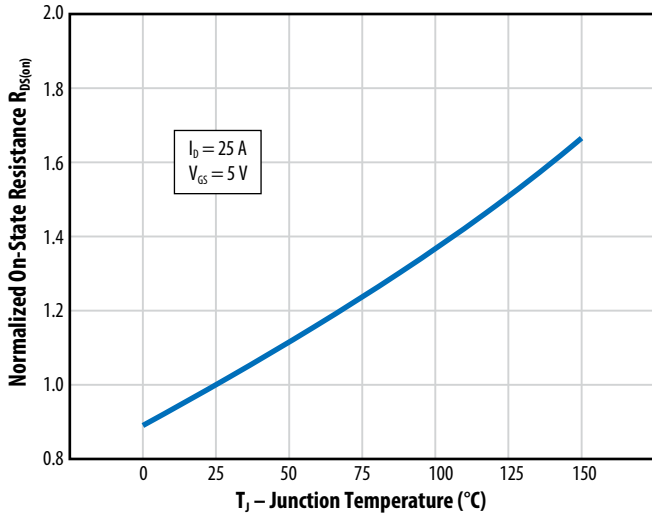


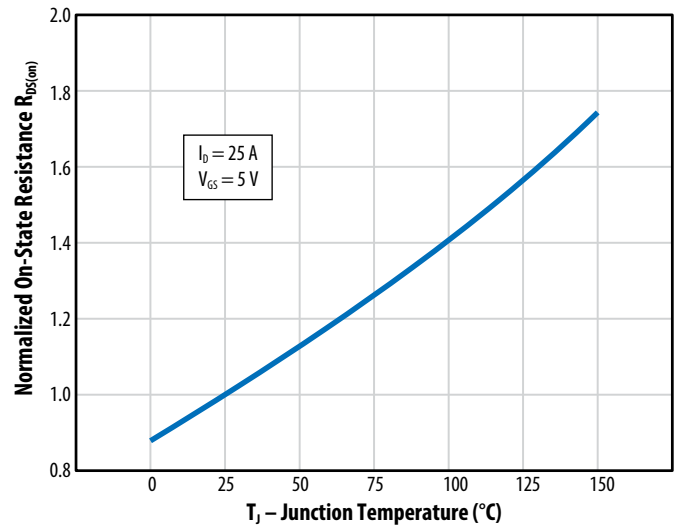
Figure 8b (Q2): Reverse Drain-Source Characteristics



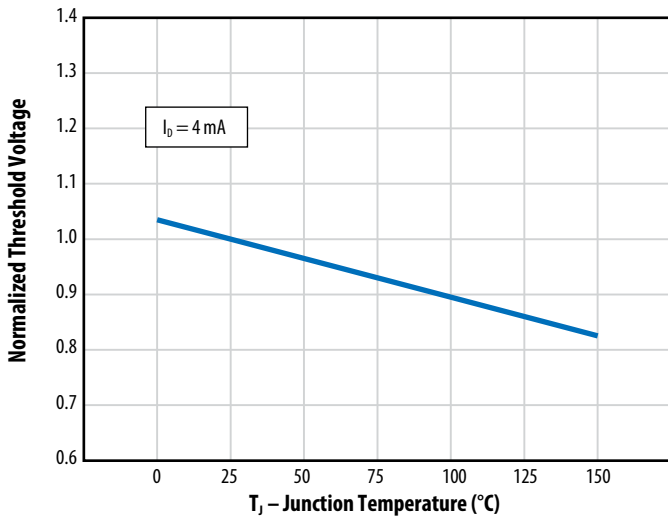
**Figure 9a (Q1):**  
Normalized On-State Resistance vs. Temperature



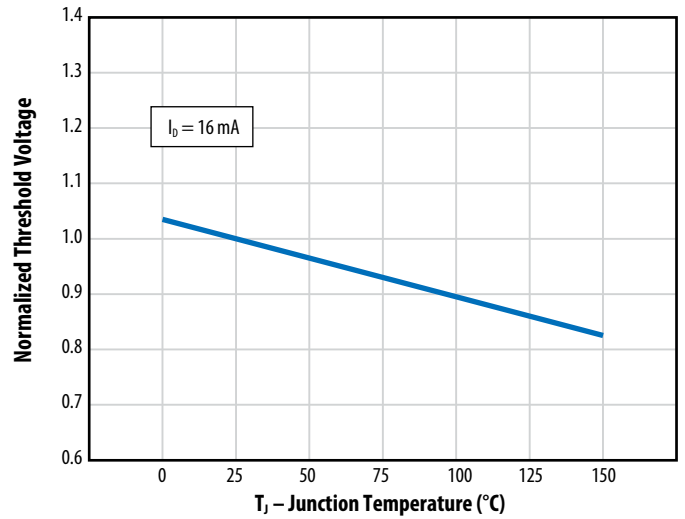
**Figure 9b (Q2):**  
Normalized On-State Resistance vs. Temperature



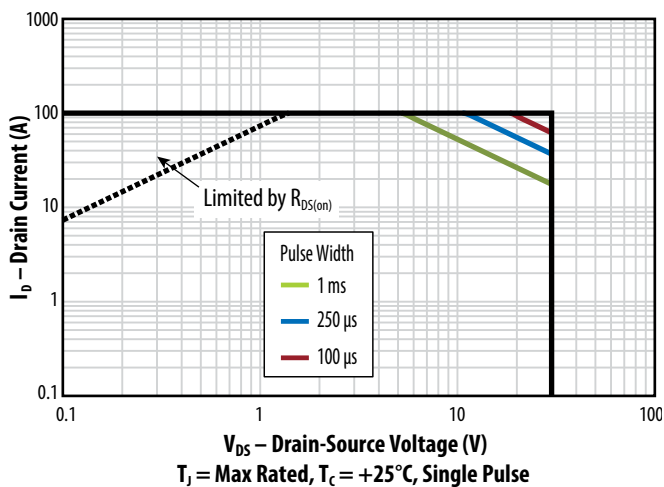
**Figure 10a (Q1):**  
Normalized Threshold Voltage vs. Temperature



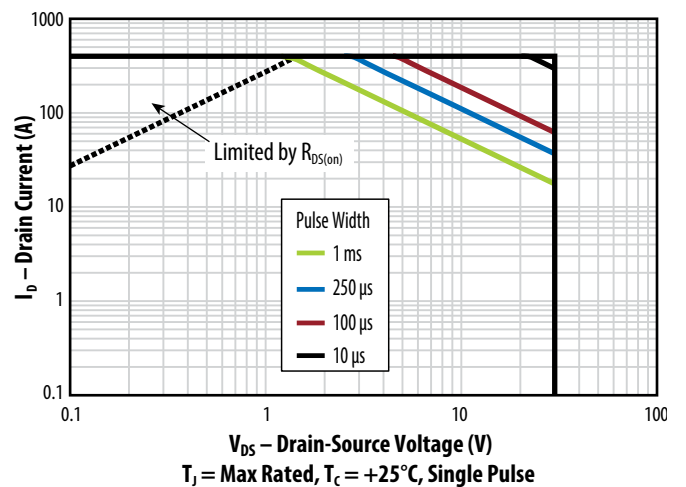
**Figure 10b (Q2):**  
Normalized Threshold Voltage vs. Temperature



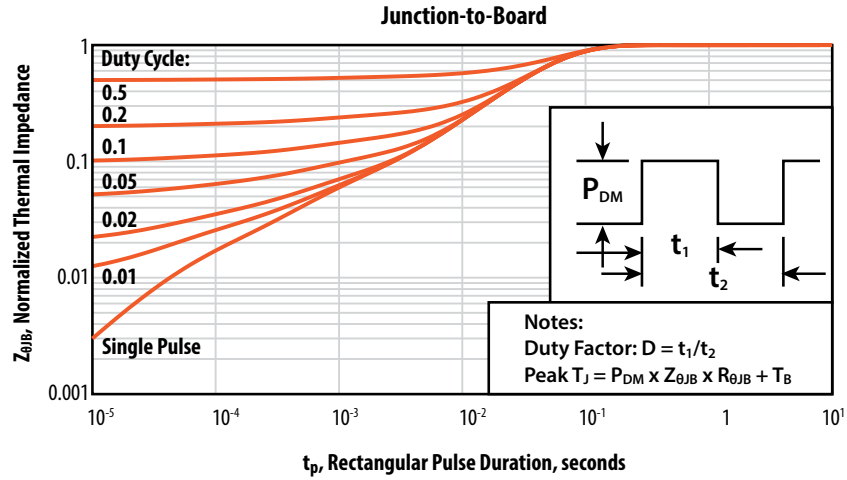
**Figure 11a (Q1): Safe Operating Area**



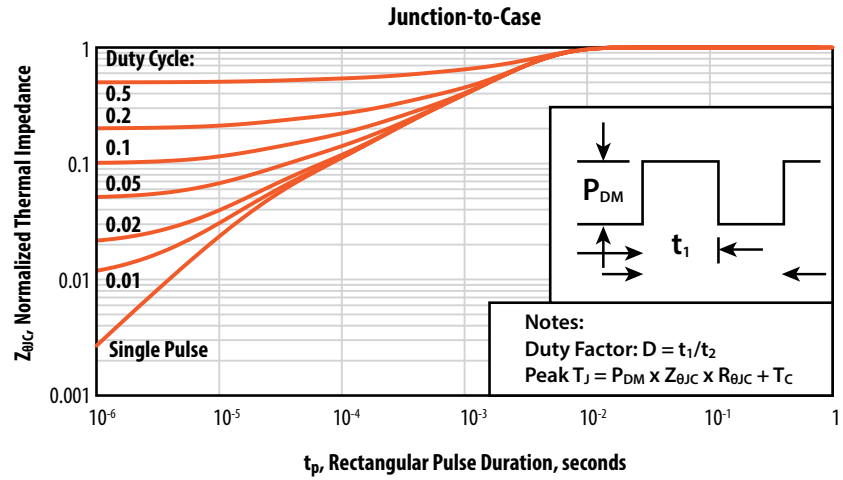
**Figure 11b (Q2): Safe Operating Area**



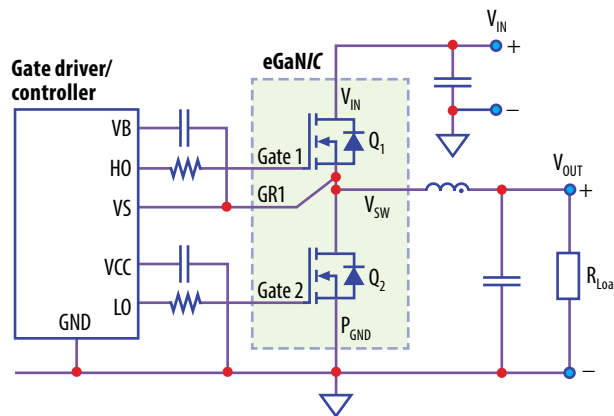
**Figure 12a**  
Transient Thermal  
Response Curves



**Figure 12b**  
Transient Thermal  
Response Curves

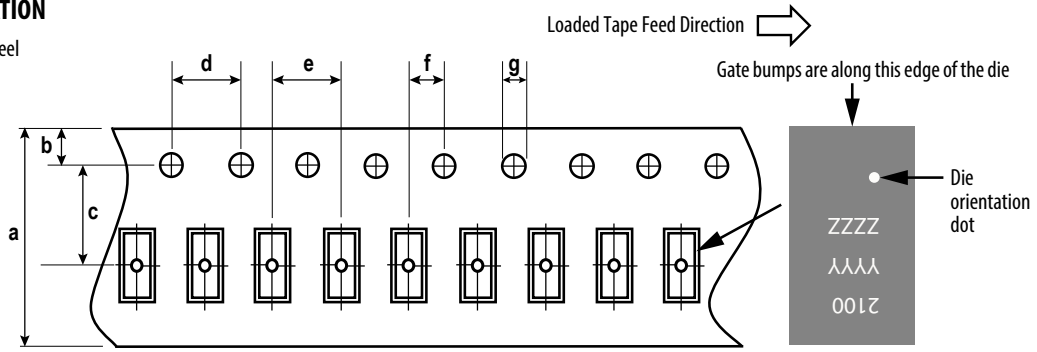
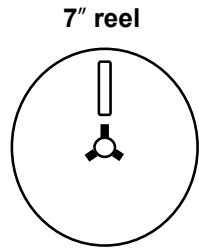


**Figure 13**  
Typical Application Circuit



**TAPE AND REEL CONFIGURATION**

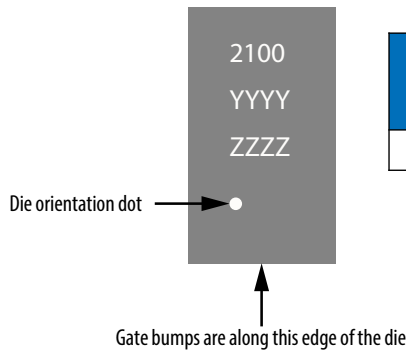
4mm pitch, 12mm wide tape on 7" reel



EPC2100 (note 1)			
Dimension (mm)	target	min	max
a	12.00	11.70	12.30
b	1.75	1.65	1.85
c (see note)	5.50	5.45	5.55
d	4.00	3.90	4.10
e	4.00	3.90	4.10
f (see note)	2.00	1.95	2.05
g	1.50	1.50	1.60

Note 1: MSL 1 (moisture sensitivity level 1) classified according to IPC/JEDEC industry standard.  
 Note 2: Pocket position is relative to the sprocket hole measured as true position of the pocket, not the pocket hole.

**DIE MARKINGS**

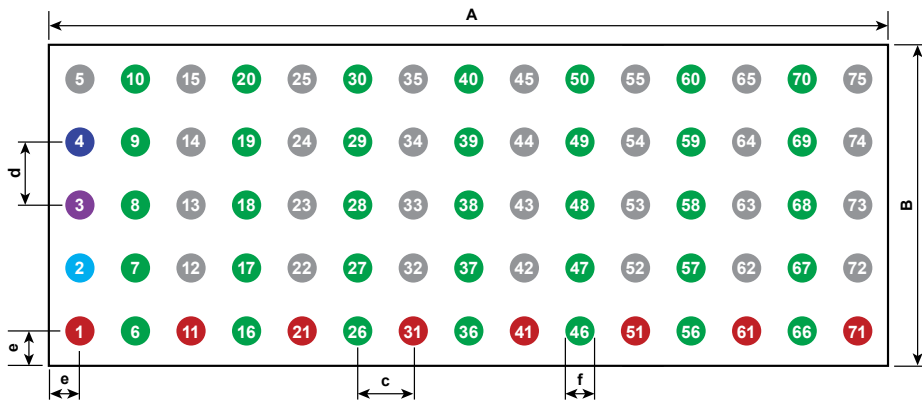


Part Number	Laser Markings		
	Part # Marking Line 1	Lot_Date Code Marking Line 2	Lot_Date Code Marking Line 3
EPC2100	2100	YYYY	ZZZZ



**DIE OUTLINE**

Solder Bump View



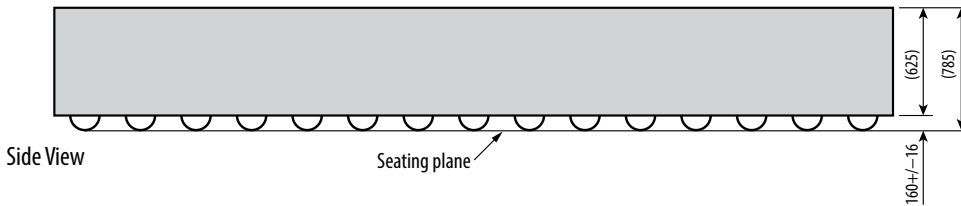
DIM	MIN	Nominal	MAX
A	6020	6050	6080
B	2270	2300	2330
c	400	400	400
d	450	450	450
e	210	225	240
f	187	208	240

Pad 2 is Gate1 (high side); Pad 4 is Gate2 (low side); Pad 3 is HS Gate Return;

Pads 5, 12, 13, 14, 15, 22, 23, 24, 25, 32, 33, 34, 35, 42, 43, 44, 45, 52, 53, 54, 55, 62, 63, 64, 65, 72, 73, 74, 75 are Ground;

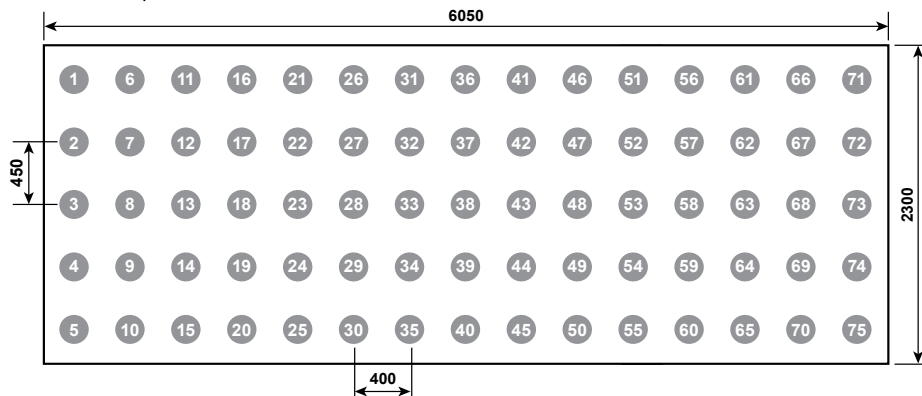
Pads 1, 11, 21, 31, 41, 51, 61, 71 are  $V_{IN}$ ;

Pads 6, 7, 8, 9, 10, 16, 17, 18, 19, 20, 26, 27, 28, 29, 30, 36, 37, 38, 39, 40, 46, 47, 48, 49, 50, 56, 57, 58, 59, 60, 66, 67, 68, 69, 70 are Switch Node



**RECOMMENDED LAND PATTERN**

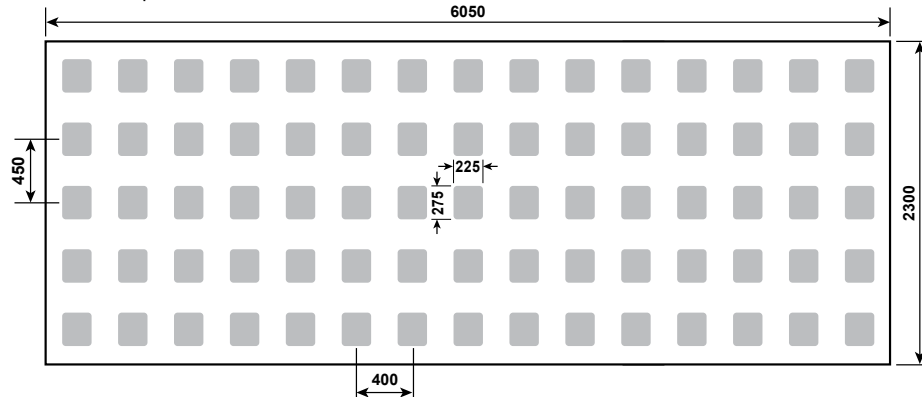
(measurements in  $\mu\text{m}$ )



The land pattern is solder mask defined. Suggest SMD Pads at  $200 +20/-10 \mu\text{m}$ .  $190 \mu\text{m}$  minimum.

**RECOMMENDED STENCIL DRAWING**

(measurements in  $\mu\text{m}$ )



Recommended stencil should be 4 mil ( $100 \mu\text{m}$ ) thick, must be laser cut, openings per drawing.

Intended for use with SAC305 Type 4 solder, reference 88.5% metals content.

Additional assembly resources available at: <https://epc-co.com/epc/DesignSupport/AssemblyBasics.aspx>

Efficient Power Conversion Corporation (EPC) reserves the right to make changes without further notice to any products herein to improve reliability, function or design. EPC does not assume any liability arising out of the application or use of any product or circuit described herein; neither does it convey any license under its patent rights, nor the rights of others.

eGaN® is a registered trademark of Efficient Power Conversion Corporation.  
EPC Patent Listing: [epc-co.com/epc/AboutEPC/Patents.aspx](https://epc-co.com/epc/AboutEPC/Patents.aspx)

Information subject to change without notice.

Revised August 2019