

**NPN Silicon AF Transistor**

- For general AF applications
- High collector current
- High current gain
- Low collector-emitter saturation voltage
- Pb-free (RoHS compliant) package
- Qualified according AEC Q101



Type	Marking	Pin Configuration						Package
		1 = B	2 = E	3 = C	-	-	-	
BC817K-16	6As	1 = B	2 = E	3 = C	-	-	-	SOT23
BC817K-16W	6As	1 = B	2 = E	3 = C	-	-	-	SOT323
BC817K-25	6Bs	1 = B	2 = E	3 = C	-	-	-	SOT23
BC817K-25W	6Bs	1 = B	2 = E	3 = C	-	-	-	SOT323
BC817K-40	6Cs	1 = B	2 = E	3 = C	-	-	-	SOT23
BC817K-40W	6Cs	1 = B	2 = E	3 = C	-	-	-	SOT323
BC818K-16W	6Es	1 = B	2 = E	3 = C	-	-	-	SOT323
BC818K-40	6Gs	1 = B	2 = E	3 = C	-	-	-	SOT23

**Maximum Ratings**

Parameter	Symbol	Value	Unit
Collector-emitter voltage BC817... BC818...	$V_{CEO}$	45 25	V
Collector-base voltage BC817... BC818...	$V_{CBO}$	50 30	
Emitter-base voltage	$V_{EBO}$	5	
Collector current	$I_C$	500	mA
Peak collector current	$I_{CM}$	1000	
Base current	$I_B$	100	
Peak base current	$I_{BM}$	200	
Total power dissipation- $T_S \leq 115\text{ °C}$ , BC817K, BC818K $T_S \leq 130\text{ °C}$ , BC817KW, BC818KW	$P_{tot}$	500 250	mW
Junction temperature	$T_j$	150	°C
Storage temperature	$T_{stg}$	-65 ... 150	

**Thermal Resistance**

Parameter	Symbol	Value	Unit
Junction - soldering point <sup>1)</sup> BC817K, BC818K BC817KW, BC818KW	$R_{thJS}$	$\leq 70$ $\leq 80$	K/W

<sup>1</sup>For calculation of  $R_{thJA}$  please refer to Application Note AN077 (Thermal Resistance Calculation)

**Electrical Characteristics at  $T_A = 25^\circ\text{C}$ , unless otherwise specified**

Parameter	Symbol	Values			Unit
		min.	typ.	max.	
<b>DC Characteristics</b>					
Collector-emitter breakdown voltage $I_C = 10\text{ mA}$ , $I_B = 0$ , BC817... $I_C = 10\text{ mA}$ , $I_B = 0$ , BC818...	$V_{(BR)CEO}$	45 25	- -	- -	V
Collector-base breakdown voltage $I_C = 10\text{ }\mu\text{A}$ , $I_E = 0$ , BC817... $I_C = 10\text{ }\mu\text{A}$ , $I_E = 0$ , BC818...	$V_{(BR)CBO}$	50 30	- -	- -	-
Emitter-base breakdown voltage $I_E = 10\text{ }\mu\text{A}$ , $I_C = 0$	$V_{(BR)EBO}$	5	-	-	V
Collector-base cutoff current $V_{CB} = 25\text{ V}$ , $I_E = 0$ $V_{CB} = 25\text{ V}$ , $I_E = 0$ , $T_A = 150^\circ\text{C}$	$I_{CBO}$	- -	- -	0.1 50	$\mu\text{A}$
Emitter-base cutoff current $V_{EB} = 4\text{ V}$ , $I_C = 0$	$I_{EBO}$	-	-	100	nA
DC current gain <sup>1)</sup> $I_C = 100\text{ mA}$ , $V_{CE} = 1\text{ V}$ , $h_{FE}$ -grp.16 $I_C = 100\text{ mA}$ , $V_{CE} = 1\text{ V}$ , $h_{FE}$ -grp.25 $I_C = 100\text{ mA}$ , $V_{CE} = 1\text{ V}$ , $h_{FE}$ -grp.40 $I_C = 500\text{ mA}$ , $V_{CE} = 1\text{ V}$ , all $h_{FE}$ -grps.	$h_{FE}$	100 160 250 40	160 250 350 -	250 400 630 -	-
Collector-emitter saturation voltage <sup>1)</sup> $I_C = 500\text{ mA}$ , $I_B = 50\text{ mA}$	$V_{CEsat}$	-	-	0.7	V
Base emitter saturation voltage <sup>1)</sup> $I_C = 500\text{ mA}$ , $I_B = 50\text{ mA}$	$V_{BEsat}$	-	-	1.2	

<sup>1)</sup>Pulse test:  $t < 300\mu\text{s}$ ;  $D < 2\%$

**Electrical Characteristics** at  $T_A = 25^\circ\text{C}$ , unless otherwise specified

Parameter	Symbol	Values			Unit
		min.	typ.	max.	
<b>AC Characteristics</b>					
Transition frequency $I_C = 50\text{ mA}, V_{CE} = 5\text{ V}, f = 100\text{ MHz}$	$f_T$	-	170	-	MHz
Collector-base capacitance $V_{CB} = 10\text{ V}, f = 1\text{ MHz}$	$C_{cb}$	-	3	-	pF
Emitter-base capacitance $V_{EB} = 0.5\text{ V}, f = 1\text{ MHz}$	$C_{eb}$	-	40	-	

**DC current gain  $h_{FE} = f(I_C)$**

$V_{CE} = 1\text{ V}$

$h_{FE}\text{-grp.16}$

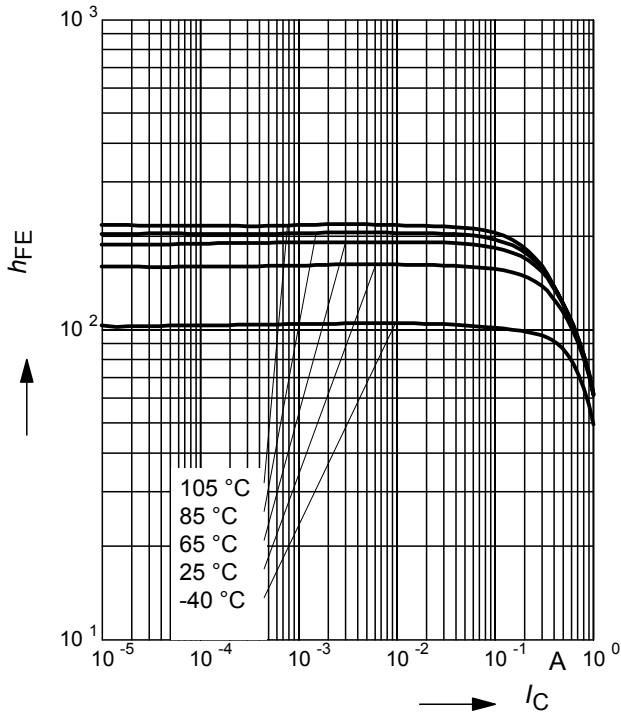

**DC current gain  $h_{FE} = f(I_C)$**

$V_{CE} = 1\text{ V}$

$h_{FE}\text{-grp.25}$

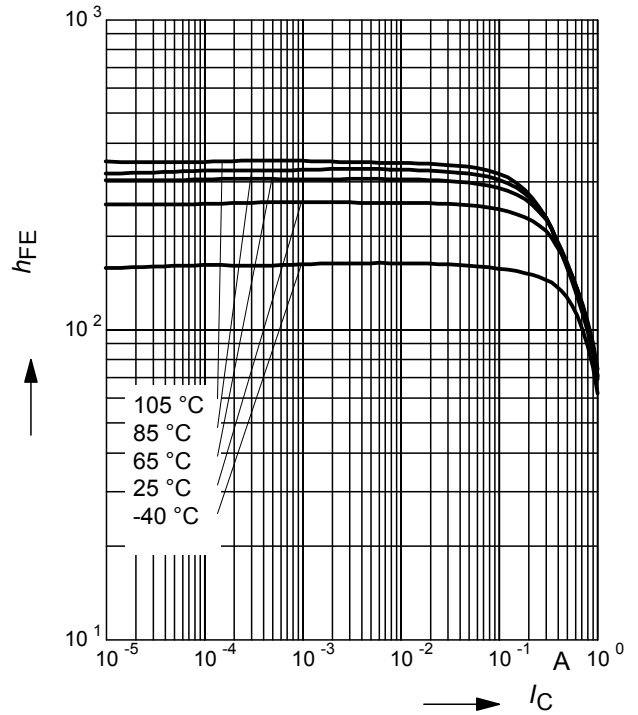

**DC current gain  $h_{FE} = f(I_C)$**

$V_{CE} = 1\text{ V}$

$h_{FE}\text{-grp.40}$

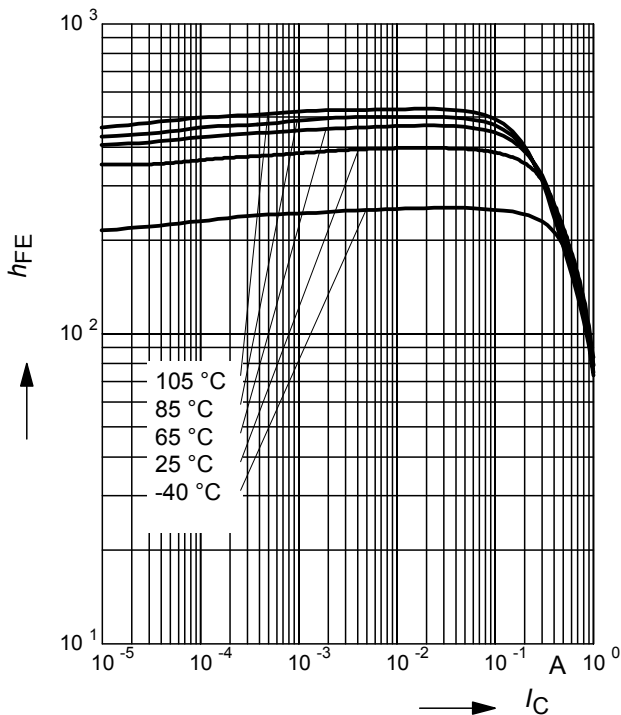

**Collector-emitter saturation voltage**

$I_C = f(V_{CEsat}), h_{FE} = 10$

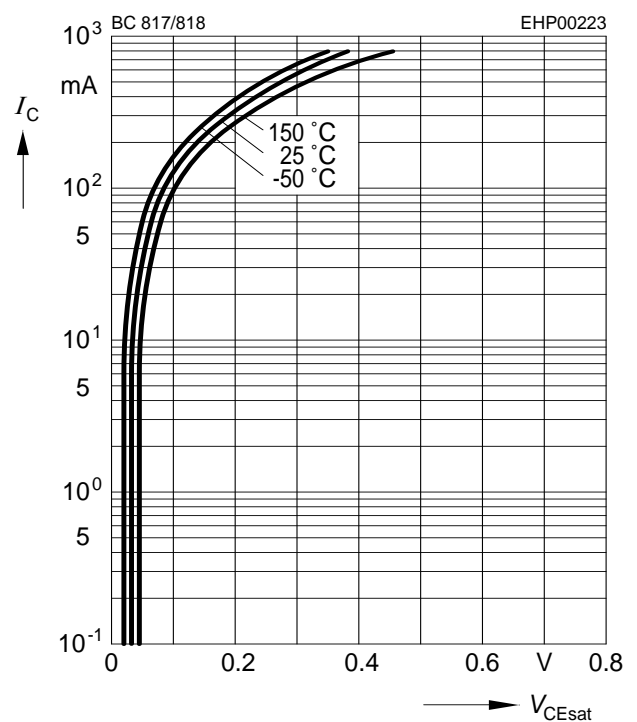

**Base-emitter saturation voltage**

$I_C = f(V_{BEsat}), h_{FE} = 10$

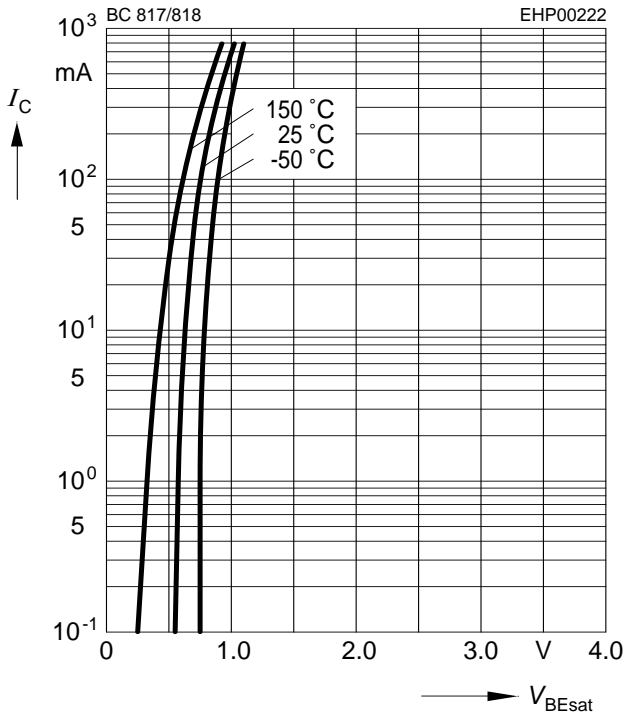

**Collector cutoff current  $I_{CBO} = f(T_A)$**

$V_{CBO} = 25 V$

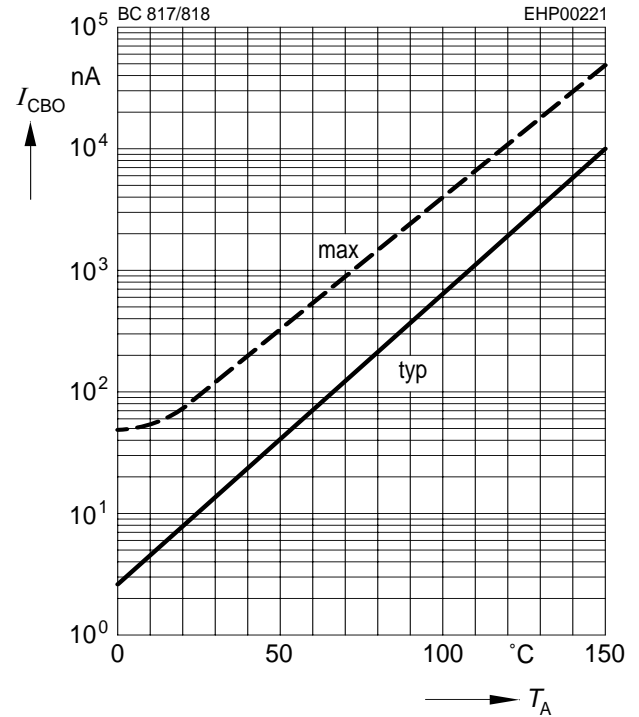

**Transition frequency  $f_T = f(I_C)$**

$V_{CE} = \text{parameter in V}, f = 2 \text{ GHz}$

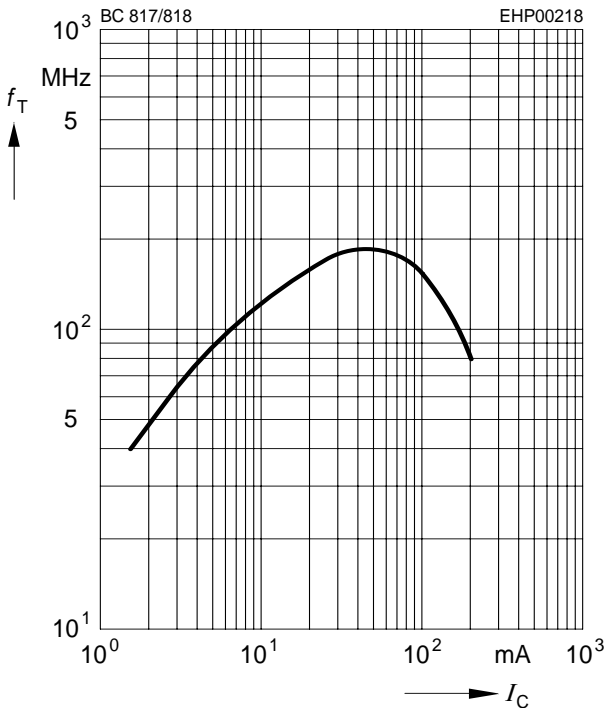

**Collector-base capacitance  $C_{cb} = f(V_{CB})$**

**Emitter-base capacitance  $C_{eb} = f(V_{EB})$**

BC817K, BC818K

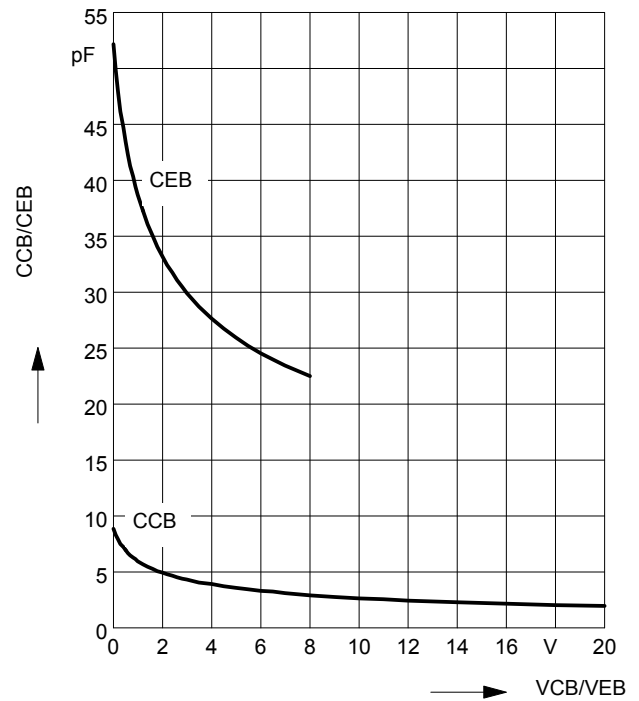

**Total power dissipation  $P_{tot} = f(T_S)$**

BC817K, BC818K

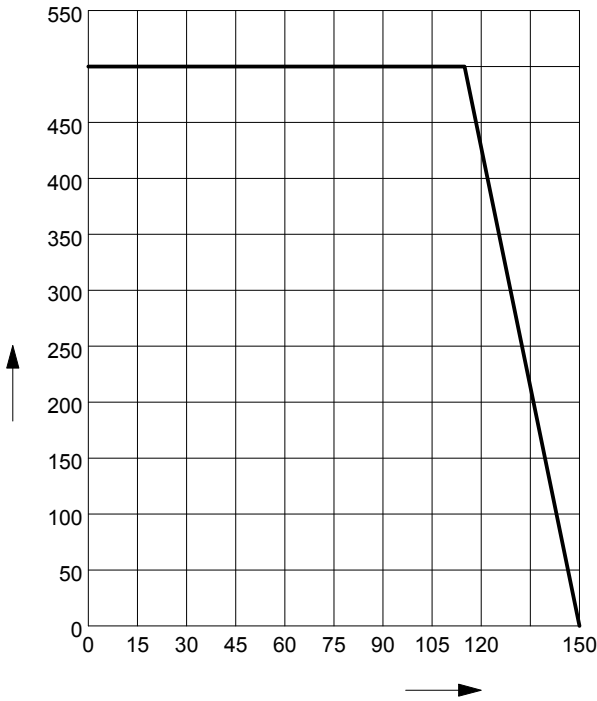

**Total power dissipation  $P_{tot} = f(T_S)$**

BC817KW, BC818KW

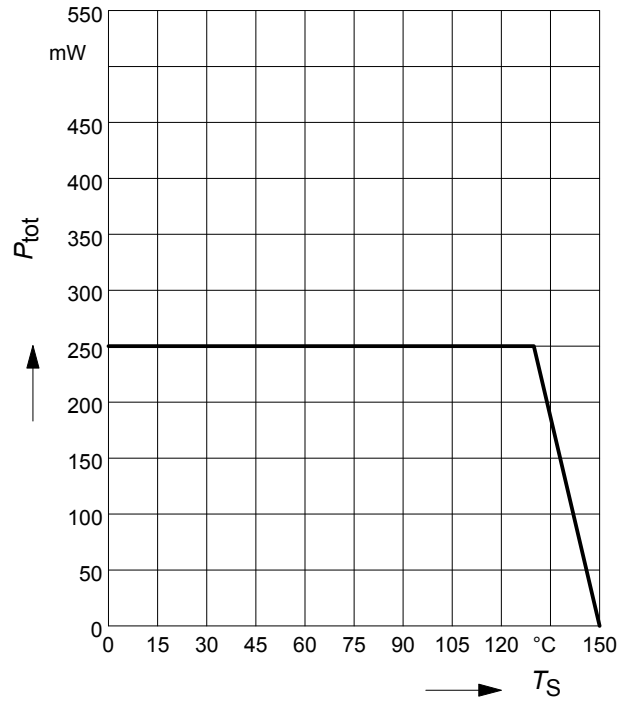

**Permissible Pulse Load  $R_{thJS} = f(t_p)$**

BC817K, BC818K

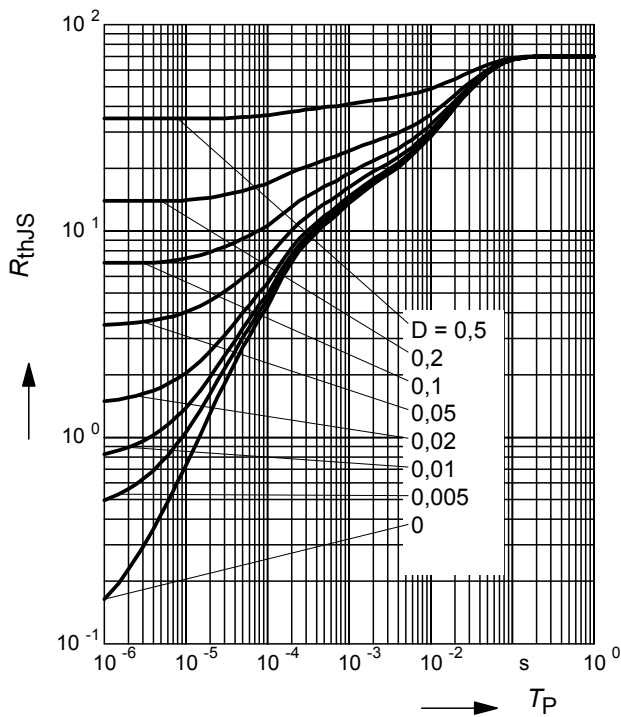

**Permissible Pulse Load**

$P_{totmax}/P_{totDC} = f(t_p)$

BC817K, BC818K

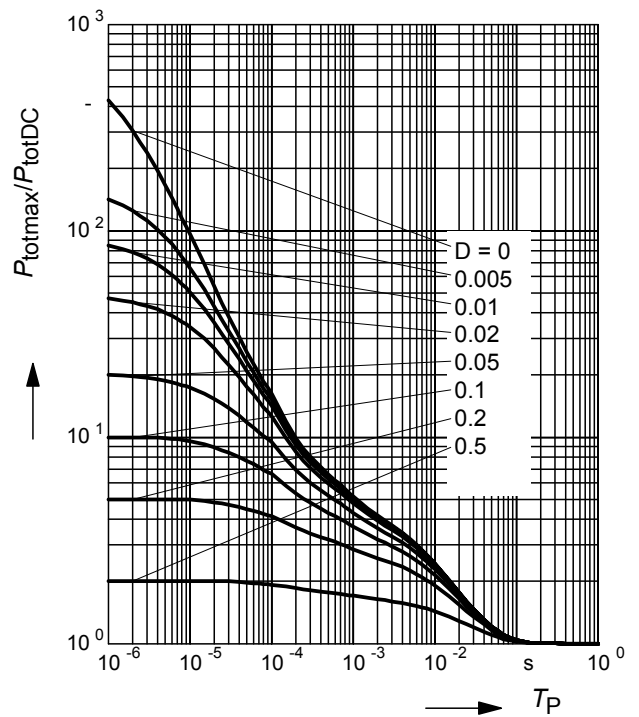

**Permissible Puls Load  $R_{thJS} = f(t_p)$**

BC817KW, BC818KW

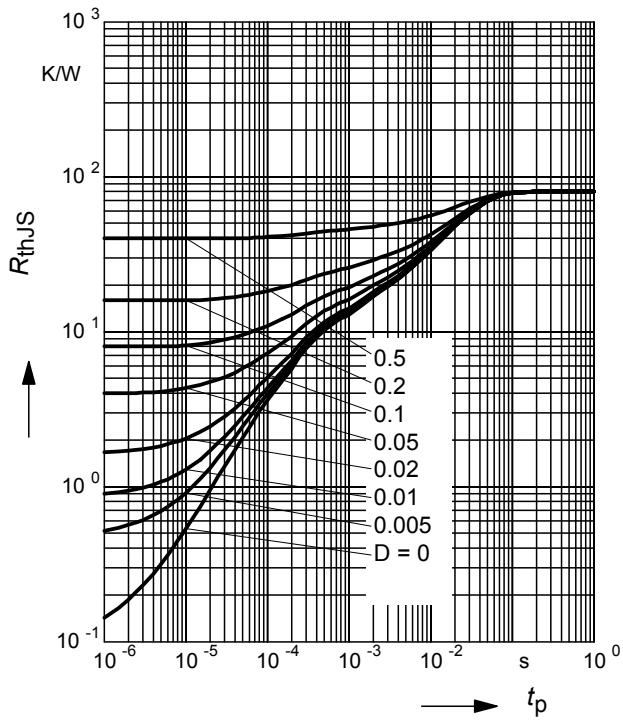

**Permissible Pulse Load**

$P_{totmax}/P_{totDC} = f(t_p)$

BC817KW, BC818KW

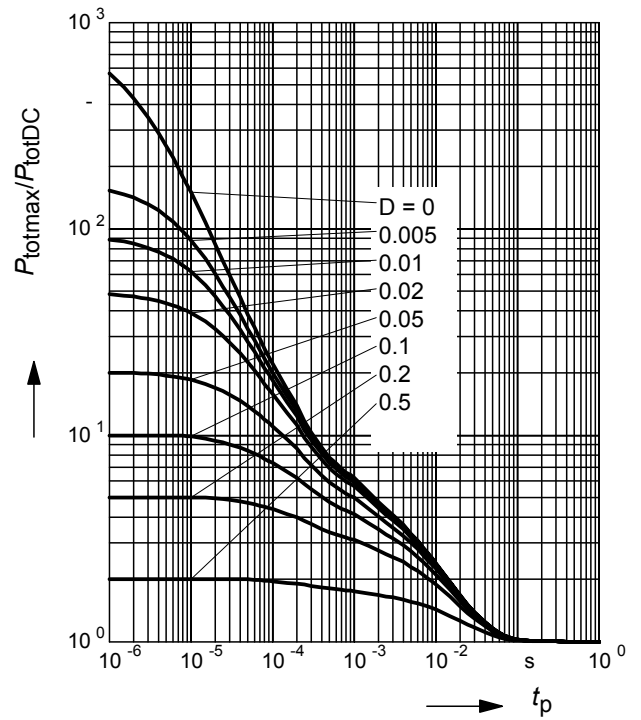



Package Outline



1) Lead width can be 0.6 max. in dambar area

Foot Print

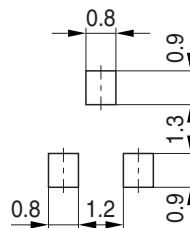

Marking Layout (Example)

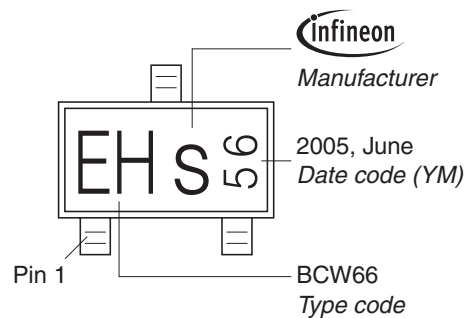

Standard Packing

Reel  $\varnothing$ 180 mm = 3.000 Pieces/Reel  
 Reel  $\varnothing$ 330 mm = 10.000 Pieces/Reel

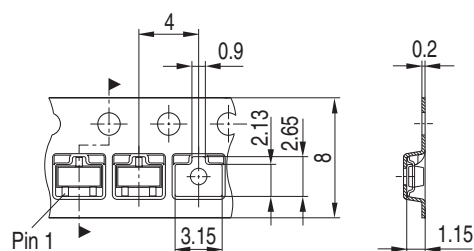

Package Outline

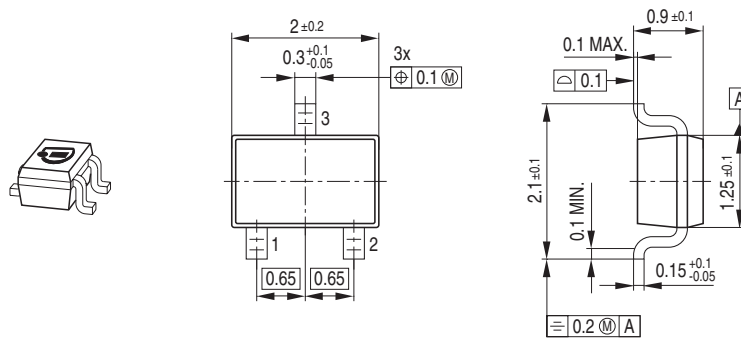

Foot Print



Marking Layout (Example)



Standard Packing

Reel  $\varnothing$ 180 mm = 3.000 Pieces/Reel  
 Reel  $\varnothing$ 330 mm = 10.000 Pieces/Reel

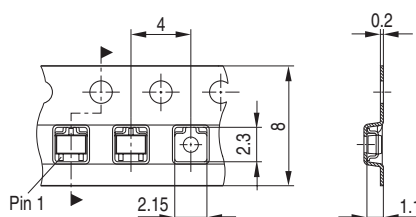

**Edition 2009-11-16**

**Published by  
Infineon Technologies AG  
81726 Munich, Germany**

**© 2009 Infineon Technologies AG  
All Rights Reserved.**

### **Legal Disclaimer**

The information given in this document shall in no event be regarded as a guarantee of conditions or characteristics. With respect to any examples or hints given herein, any typical values stated herein and/or any information regarding the application of the device, Infineon Technologies hereby disclaims any and all warranties and liabilities of any kind, including without limitation, warranties of non-infringement of intellectual property rights of any third party.

### **Information**

For further information on technology, delivery terms and conditions and prices, please contact the nearest Infineon Technologies Office ([www.infineon.com](http://www.infineon.com)).

### **Warnings**

Due to technical requirements, components may contain dangerous substances. For information on the types in question, please contact the nearest Infineon Technologies Office.

Infineon Technologies components may be used in life-support devices or systems only with the express written approval of Infineon Technologies, if a failure of such components can reasonably be expected to cause the failure of that life-support device or system or to affect the safety or effectiveness of that device or system. Life support devices or systems are intended to be implanted in the human body or to support and/or maintain and sustain and/or protect human life. If they fail, it is reasonable to assume that the health of the user or other persons may be endangered.