

# UWPA, UWPM



## Long-range wireless gateway: endpoint adapter and master concentrator



### Description

UWPA is an endpoint adapter that provides LoRa® or LoRaWAN® communication to an RS485 Carlo Gavazzi meter. UWPM is a master concentrator that permits UWP 3.0 to gather data from multiple UWPA.

### Benefits

- **Long range communication.** Up to 10 km range in open air, 1 km in typical applications.
- **Low operating expenses.** Wireless solution (EU 868 MHz ISM band and US 915 MHz ISM band) with no SIM card or annual fees.
- **Easy and fast configuration** via free software.
- **Easy commissioning and diagnostics** thanks to the push button for communication test.
- **Security.** Embedded end-to-end AES128 encryption.
- **Reliable communication** thanks to high-performance antenna, interferences/obstacles immunity and downlink server acknowledge.
- **Compatibility.** It permits to interface a Carlo Gavazzi meter and analyser with standard third-party LoRaWAN® networks or with UWP 3.0 platform.

### Applications

Energy efficiency monitoring and energy cost allocation, sub-metering in large buildings, big facilities, farms and city areas are the best use cases for long range wireless Carlo Gavazzi systems. Thanks to LoRa®/LoRaWAN® long communication range, security and robustness, wireless networks can be easily set-up, without high expenses due to the use of SIM cards or repeaters.

### Main functions

- LoRa®/LoRaWAN® communication for a RS485 Carlo Gavazzi meter and analyser (UWPA)
- Plug'n play commissioning of a long-range wireless monitoring system based on UWP 3.0 (UWPA+UWPM)
- Integration of pulse output meters (electricity, gas and water) in combination with VMU-MC/OC.

Architecture (private UWP network)

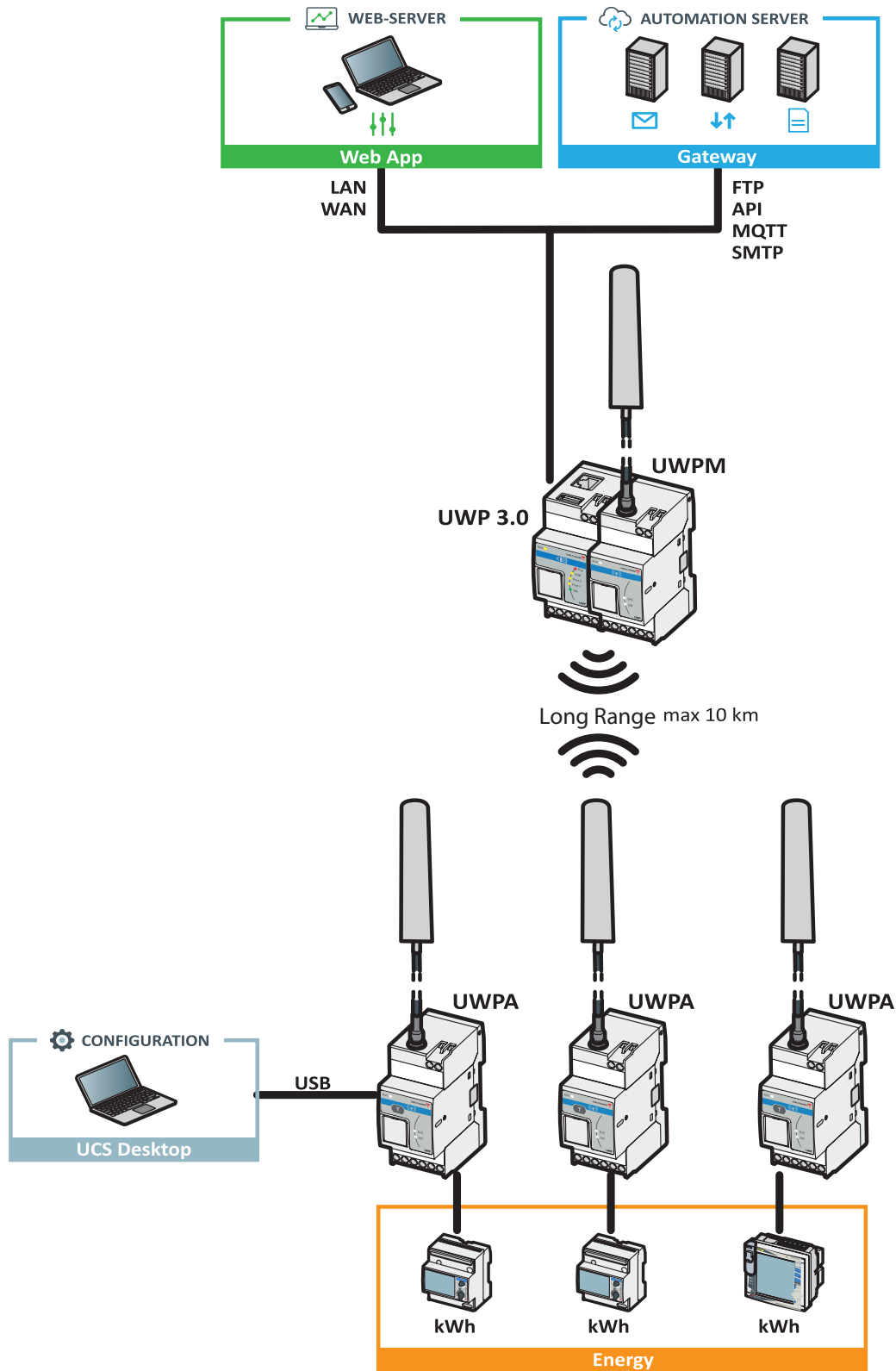

## Architecture (LoRaWAN® network)

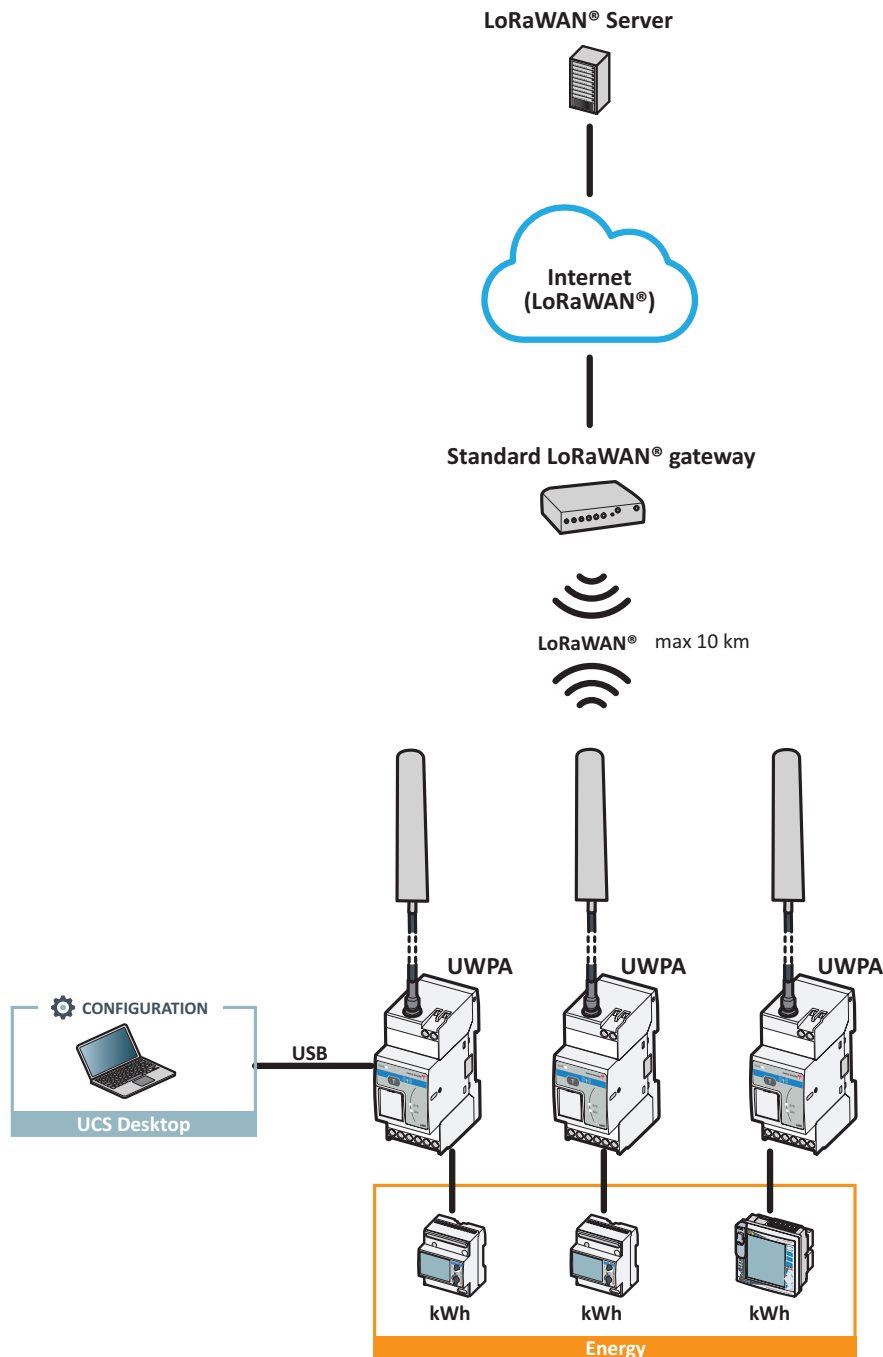

## Main features

- Compatibility with generic LoRaWAN® Gateways/Servers/Networks (UWPA)
- Full ownership of data with no need to rely on any wireless/cloud operator (UWPA+UWPM)
- EU 868 MHz ISM band communication
- US 915 MHz ISM band communication
- Up to 50 UWPA per UWPM (max. 3 UWPM per UWP 3.0)

**UCS (Universal configuration software) specifications**

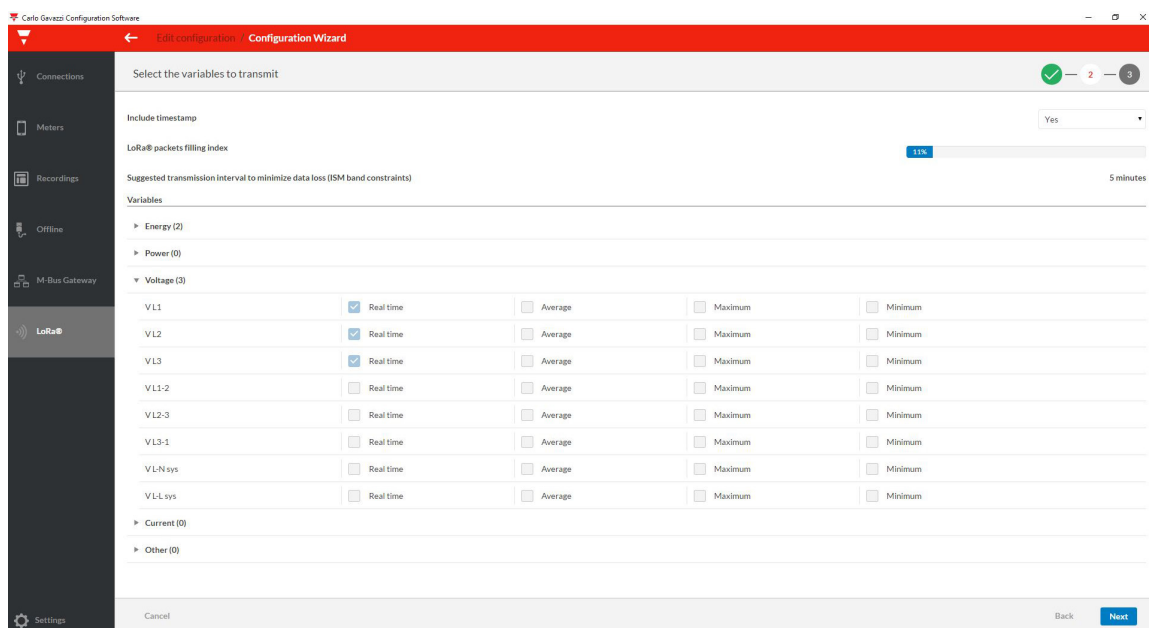
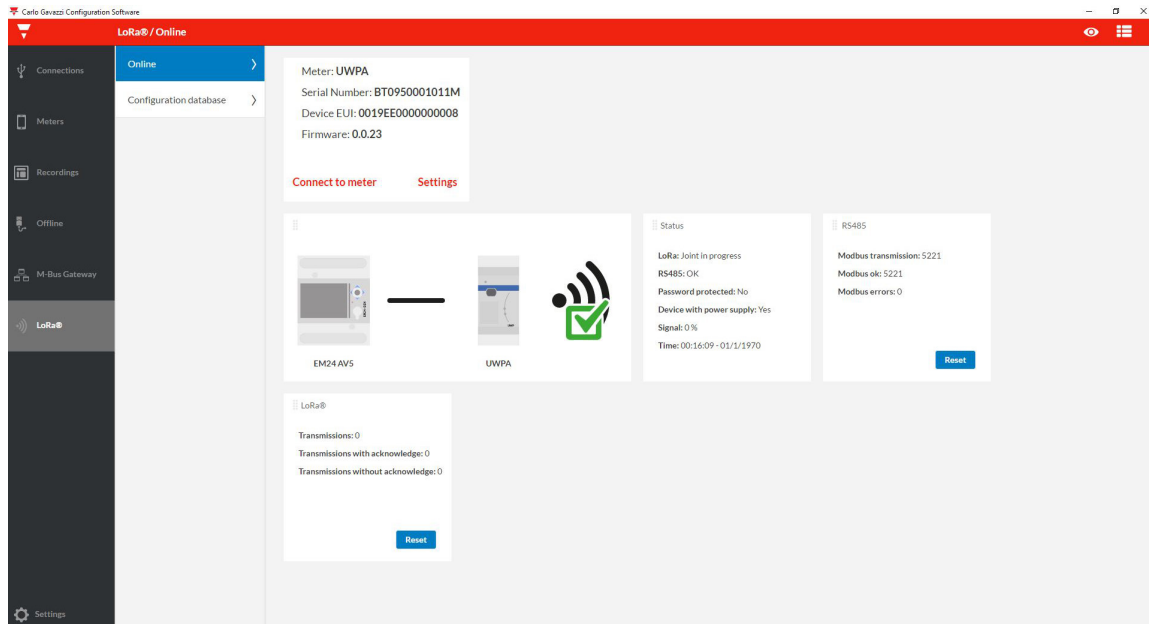

- Free software, compatible with Windows® PCs
- Intuitive user interface
- The same software for configuring UWPA and a Carlo Gavazzi meter
- UWPA password management for protecting your LoRa®/LoRaWAN® network
- Configurations database for helping system integrators
- Real time diagnostics and datalogging
- Export of .csv or Excel files from the configured devices list for an easy integration into LoRaWAN® network
- Export of the configured devices file for the UWP network to import into UWP 3.0

# UWPA



## Wireless endpoint gateway



### Main features

- Gateway from RS485 to LoRa®/LoRaWAN® for Carlo Gavazzi meters (one meter for each UWPA)
- USB port for easy set-up via UCS Software
- Universal power supply
- Configurable LoRaWAN® communication
- OTAA or ABP authentication
- Long communication range (10 km in open air, from 200 m to 3 km in typical applications)
- Communication interval from 5 min to 24 h
- Remote diagnostics via LoRa® RF technology communication
- LED indication of operating status

### Description

UWPA is a device to be connected to a Carlo Gavazzi meter via RS485. The resulting system transmits measured data either to standard third-party LoRaWAN® systems or to the UWPM concentrator using LoRa® technology.

### Applications

Energy efficiency monitoring and energy cost allocation, sub-metering in large buildings, big facilities, farms and city areas are the best use cases for long range wireless Carlo Gavazzi systems. Thanks to LoRa®/LoRaWAN® long communication range, security and robustness, wireless networks can be easily set-up, without high expenses due to the use of SIM cards or repeaters.

### Main functions

- LoRa®/LoRaWAN® communication for RS485 Carlo Gavazzi meters and analyzers
- Plug'n play commissioning of a LoRa®-based monitoring system based on UWP 3.0 (in combination with UWPM)
- Compatibility with standard third-party LoRaWAN® Gateways/Servers/Networks
- Full ownership of data with no need to rely on any wireless/cloud operator (in combination with UWPM)
- Local diagnostics thanks to micro-USB connection and dashboard displaying the status in UCS software
- Communication test via push button

## Structure

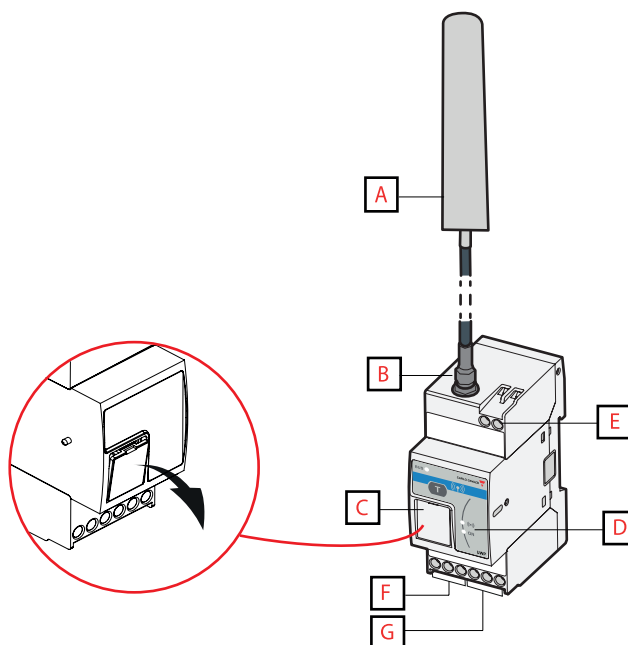

Area	Description
A	High-performance antenna
B	Antenna connector
C	USB port
D	LEDs: Green: Power supply Yellow: RS485 Blue: LoRa®
E	Power supply connection block
F	Terminals for RS485 connection to meter
G	Terminals for RS485 termination

## Special functions

- Meter auto scan via RS485
- Powered by USB for setting up without an external power supply
- Password protected configuration
- The same software (UCS) to configure both UWPA and connected device
- Adapter firmware upgrade: user can select the firmware file and activate the firmware upgrade procedure
- Clock synchronization with server time via wireless downlink

 LED indication

Colour	Status LED	Description
Green	ON	Power supply OK
	OFF	No Power supply
	Fast Blinking	Hardware failure
Yellow	ON	Communication in progress without errors
	OFF	Communication disabled
	Slow blinking	Meter auto scan in progress
	Fast blinking	Not valid meters or communication error
Blue	ON	Push button disabled to comply with ISM band restrictions on duty cycle
	OFF	LoRa® RF technology communication disabled or network joint successfully executed (waiting for the next communication)
	Slow blinking	Communication in progress
	Fast blinking	Network joint not executed or communication failed

# Features

## General

<b>Material</b>	Noryl, self-extinguishing V-0 (UL 94)
<b>Protection degree</b>	Front: IP50 Terminals: IP20 Antenna: IP65
<b>Terminals</b>	Cable Section: 1.5 mm <sup>2</sup> Torque: from 0.4 to 0.8 Nm
<b>Mounting</b>	DIN rail
<b>Dimensions</b>	2-DIN module
<b>Weight (packaging included)</b>	520 g
<b>Antenna cable length</b>	2 m
<b>Antenna dimensions</b>	See picture 2

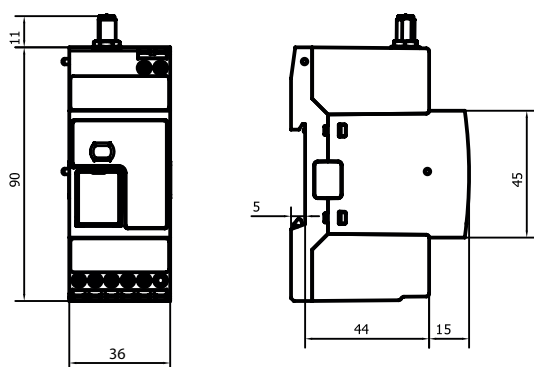

Fig. 1 UWPA dimensions

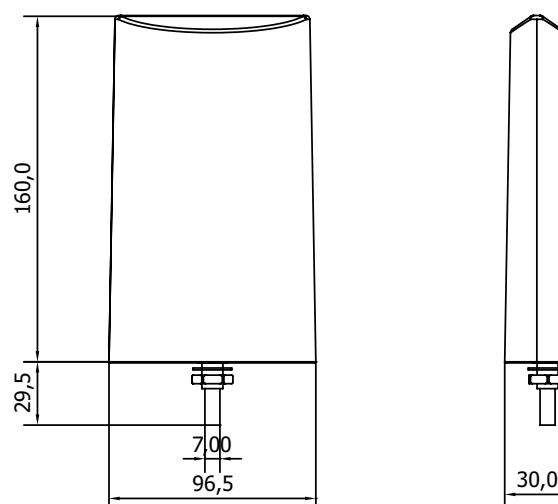

Fig. 2 High-performance antenna dimensions

## Power supply

<b>Power supply</b>	24 V dc +/-20% 115-240 V ac 50/60 Hz +/-10%
<b>Consumption</b>	DC: 1.3 W max. AC: 5.5 VA max.
<b>Connector</b>	Screw terminals

## Environmental specifications

<b>Operating temperature</b>	-25° to +55°
<b>Storage temperature</b>	-30° to +70°

NOTE: R.H. < 90% non-condensing



**Input and output insulation**

	Power supply	RS485	USB
Power supply	-	4 kV VRMS	4 kV VRMS
RS485	4 kV VRMS	-	0.5 kV VRMS
USB	4 kV VRMS	0.5 kV VRMS	-

# Communication

## ▶ RS485 port

<b>Communication type</b>	Multidrop, bidirectional (static and dynamic variables)
<b>Connection type</b>	Screw terminals 3 wires
<b>Protocol</b>	Modbus RTU
<b>Data</b>	All
<b>Data format</b>	1 start bit, 8 data bits, Parity (None/ Odd/ Even), 1 or 2 stop bit
<b>Configuration parameters</b>	Modbus address (from 1 to 247) Baud rate: 4.8 / 9.6 / 19.2 / 38.4 / 57.6 / 115.2 kbps Parity (None/ Odd/ Even) Stop bit (1 or 2)
<b>Maximum number of connected devices</b>	1 meter x 1 UWPA



## ▶ USB port

<b>Type</b>	USB2.0/USB3.0
<b>Connection type</b>	Micro-USB
<b>Protocol</b>	JBUS/Modbus compatible
<b>Configuration parameters</b>	Modbus address (from 1 to 247) Baud rate: 4.8 / 9.6 / 19.2 / 38.4 / 57.6 / 115.2 kbps Parity (None/ Odd/ Even) Stop bit (1 or 2)

## ▶ LoRa® and LoRaWAN®

<b>Protocol</b>	LoRa® (private UWP network, in combination with UWPM) or LoRaWAN® (LoRaWAN® network)
<b>Configuration parameters</b>	Transmission interval Authentication type (ABP or OTAA) Appkey or Appskey and Nwkskey
<b>Frequency</b>	EU 868 MHz ISM band US 915 MHz ISM band
<b>Encryption</b>	Embedded end-to-end AES128 encryption
<b>Transmission interval</b>	Configurable from 5 min to 24 h
<b>Antenna</b>	Included high performance antenna (SMA connector, cable length 2m)
<b>Test function</b>	Push button command for diagnostic or commissioning purposes

## Connection Diagrams

 0.4-0.8 Nm  
 1.5 mm<sup>2</sup>

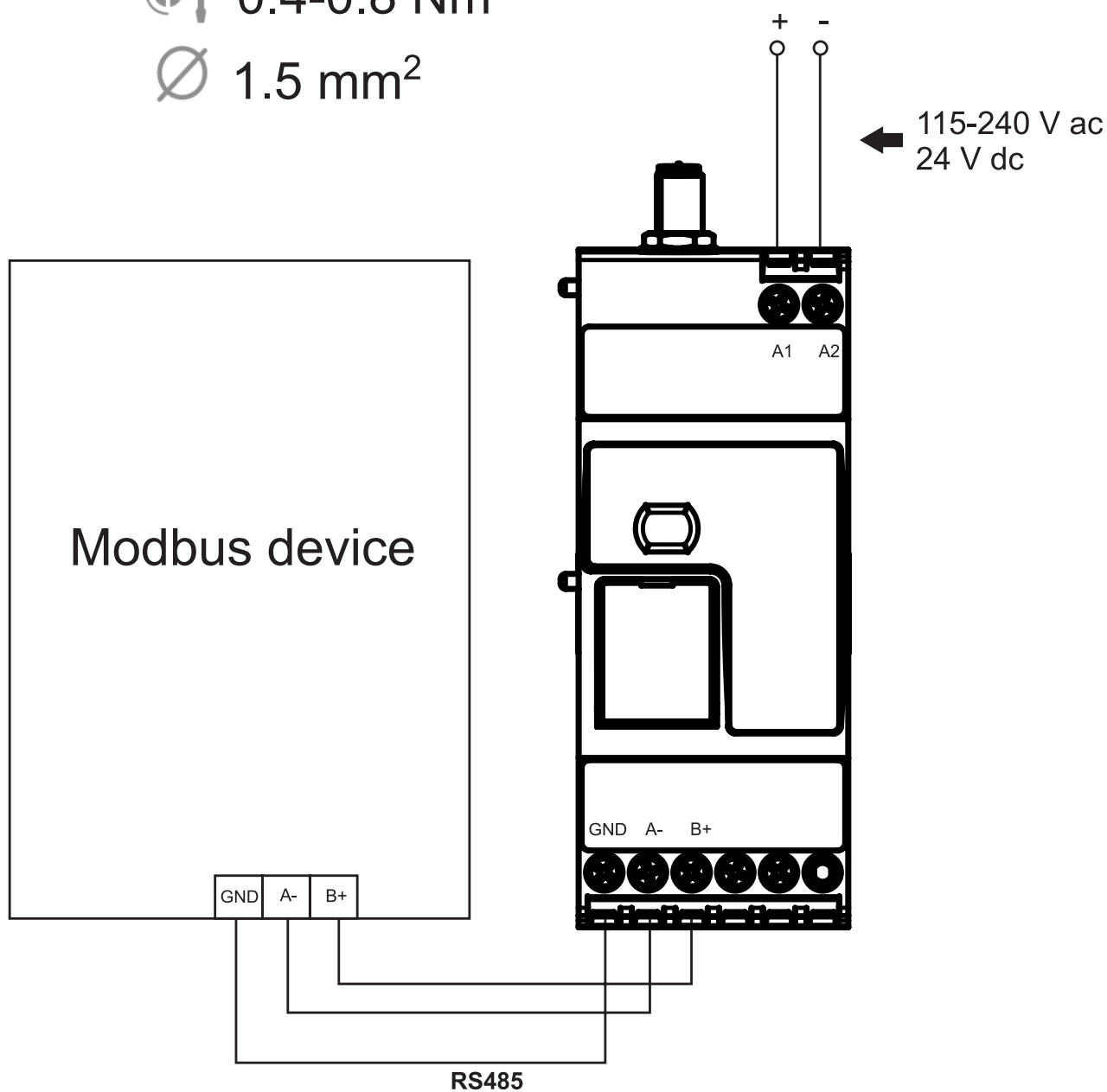

## References







### Further reading

Document	Where to find it
Guidelines	<a href="http://www.productselection.net/Pdf/UK/UWP-A-M-Guidelines.pdf">www.productselection.net/Pdf/UK/UWP-A-M-Guidelines.pdf</a>
Instruction manual	<a href="http://www.productselection.net/MANUALS/UK/UWPA_im.pdf">www.productselection.net/MANUALS/UK/UWPA_im.pdf</a>
	<a href="http://www.productselection.net/MANUALS/UK/UWPA_USA_im.pdf">www.productselection.net/MANUALS/UK/UWPA_USA_im.pdf</a>

### CARLO GAVAZZI compatible components

Purpose	Component name/code key	Notes
Energy analyzers	EM24 (family), EM210 (family), EM50	See relevant datasheet
Energy meters	EM100-300 (family)	See relevant datasheet
Power quality analyzers	WM20-30-40 (family), CPA (family)	See relevant datasheet
Power transducers	ET100-300 (family)	See relevant datasheet
Pulse concentrator	VMU-MC / OC	See relevant datasheet
Power analyzer	WM15	See relevant datasheet

**Conformity**

<b>Directives</b>	For UWPA1US1L1X	<ul style="list-style-type: none"> <li>• 2014/53/EU (RED)</li> <li>• 2011/65/EU + 2015/863/EU (RoHS)</li> </ul>
	For UWPA1US1L2X	<ul style="list-style-type: none"> <li>• FCC Rules Part 15</li> <li>• ISED compliance statements: ICES-003 / NMB 003</li> <li>• Radio compliance for Mexico: NOM-208-SCFI-2016</li> <li>• 2011/65/EU + 2015/863/EU (RoHS)</li> <li>• 2014/35/EU (LVD)</li> </ul>
<b>Standards</b>	<ul style="list-style-type: none"> <li>• Electromagnetic compatibility (EMC) - Immunity EN61000-6-2</li> <li>• Electromagnetic compatibility (EMC) - Emission EN61000-6-3</li> <li>• EN60950-1</li> <li>• ETSI EN 300 220-1</li> <li>• ETSI EN 300 220-2</li> <li>• EN62479</li> <li>• UL standard compliance: 60950-1</li> <li>• Electrical safety for Mexico: NOM-019-SCFI-1998</li> </ul>	
<b>Approvals</b>	UWPA1US1L1X and UWPA1US1L2X	  
	UWPA1US1L2X only	  
<b>Certifications</b>	LoRaWAN Certified <sup>CM</sup>	

# UWPM



## Master concentrator gateway

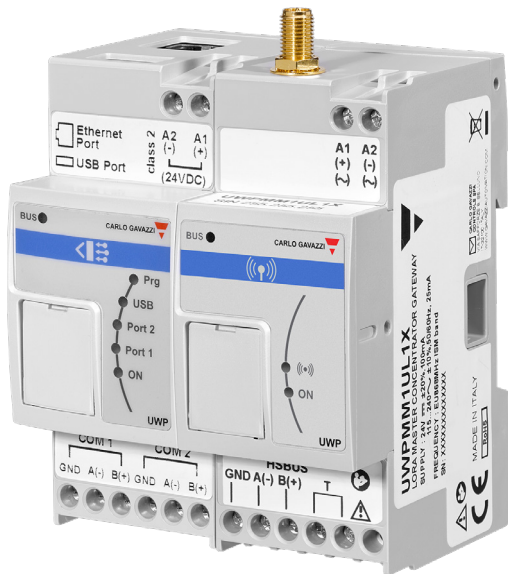

### Main features

- Wireless solution with no SIM card (ISM band)
- Data concentrator for up to 50 UWPA endpoints
- Long communication range (up to 10 km in open air)
- Fast commissioning
- Robust and secure communication
- Compatible with Carlo Gavazzi UWP 3.0 platform
- High-performance antenna

### Description

UWPM is a master concentrator that permits UWP 3.0 to gather data from multiple UWPA. This allows setting-up and operating a secure and robust wireless data network in the ISM band.

### Applications

Energy efficiency monitoring and energy cost allocation, sub-metering in large buildings, big facilities, farms and city areas are the best use cases for LoRa®-based Carlo Gavazzi systems. Thanks to LoRa® long communication range, security and robustness, wireless networks can be easily set-up, without any expenses due to the use of SIM cards or repeaters.

### Main functions

- Plug'n play commissioning of a wireless monitoring system based on UWP 3.0 (in combination with UWPA)
- Full ownership of data with no need to rely on any wireless/cloud operator (in combination with UWPA)

**Structure**

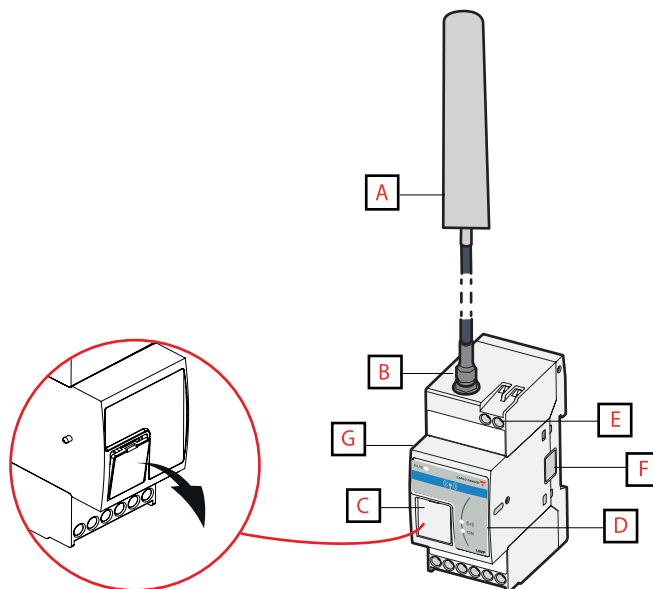

Area	Description
A	High-performance antenna
B	Antenna connector
C	USB port
D	LEDs: Green: Power supply Yellow: HSBUS Blue: LoRa®
E	Power supply connection block
F	Right-side female HSBUS connector for additional modules
G	Left-side male HSBUS connector for UWP 3.0

**Special functions**

- Fully integrated with UWP 3.0 platform
- Data gathered by UWPM can be logged, displayed, transmitted to other systems thanks to UWP 3.0 powerful capabilities

**LED indication**

Colour	Status LED	Description
Green	ON	Power supply OK
	OFF	No Power supply
	Fast Blinking	Hardware failure
Yellow	ON	HSBUS communication in progress without errors
	OFF	HSBUS communication error
	Fast blinking	
Blue	Slow blinking	Receiving message
	Fast blinking	The message is not valid or has been sent by a UWPA not included into the configuration

# Features

## General

<b>Material</b>	Noryl, self-extinguishing V-0 (UL 94)
<b>Protection degree</b>	Front: IP50 Terminals: IP20
<b>Terminals</b>	Cable Section: 1.5 mm <sup>2</sup> Torque: from 0.4 to 0.8 Nm
<b>Mounting</b>	DIN rail
<b>Dimensions</b>	2-DIN module
<b>Weight (packaging included)</b>	520 g
<b>Antenna cable length</b>	2 m
<b>Antenna dimensions</b>	See picture 2

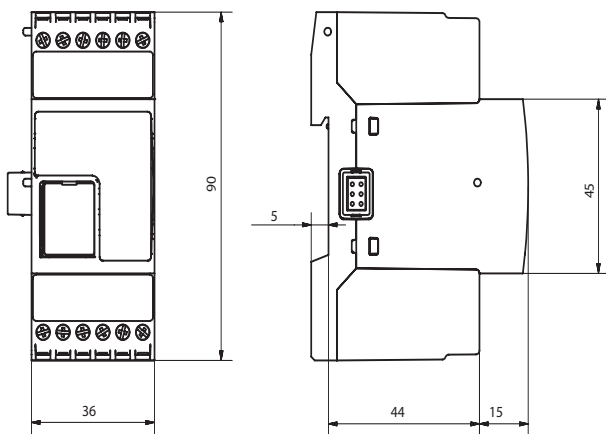

Fig. 3 UWPM dimensions

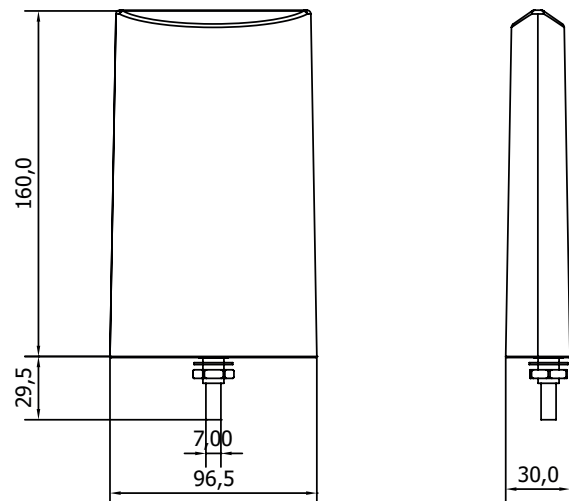

Fig. 4 High-performance antenna dimensions

## Power supply

<b>Power supply</b>	24 V dc +/-20% 115-240 V ac 50/60 Hz +/-10%
<b>Consumption</b>	DC: 1.3 W max. AC: 5.5 VA max.
<b>Connector</b>	Screw terminals

## Environmental specifications

<b>Operating temperature</b>	-25° to +55°
<b>Storage temperature</b>	-30° to +70°

NOTE: R.H. < 90% non-condensing



# Communication

## ▶ Long-range wireless

<b>Protocol</b>	LoRa® (private UWP network, in combination with UWPA)
<b>Configuration parameters</b>	Managed UWPA devices and variables by means of UCS file import
<b>Frequency</b>	EU 868 MHz ISM band US 915 MHz ISM band
<b>Encryption</b>	Embedded end-to-end AES128 encryption
<b>Antenna</b>	Included high performance antenna (SMA connector, cable length 2m)
<b>Diagnostics</b>	Signal strength UWPA status
<b>UWPA number</b>	Maximum: 50 UWPA per UWPM. The number may change according to the transmission interval and the interferences.

## ▶ HSBUS

<b>Bus type</b>	RS485 high speed bus
<b>Protocol</b>	Internal proprietary protocol
<b>Number of slaves</b>	Max. 3 per UWP 3.0
<b>Connection type</b>	By local bus (left and right connectors) or terminals GND, A(-), B(+) T1, T2: terminalization inputs

## ▶ UWPA per UWPM and transmission parameters

### 1 package (max. 8 variables\*)

Transmission interval	Maximum number of UWPA per UWPM	UCS parameters	
		Spreading factor	Retry
5 min	10	SF11	1
10 min	10	SF12	1
	50	SF11	2
15 min	50	SF12	2

### 2 packages (max. 16 variables\*)

Transmission interval	Maximum number of UWPA per UWPM	UCS parameters	
		Spreading factor	Retry
10	10	SF11	1
15	10	SF12	1
30 min	10	SF12	1
	50	SF11	2



		UCS parameters	
Transmission interval	Maximum number of UWPA per UWPM	Spreading factor	Retry
1 h	50	SF12	2

**3 packages (max. 24 variables\*)**

		UCS parameters	
Transmission interval	Maximum number of UWPA per UWPM	Spreading factor	Retry
15 min	10	SF11	1
30 min	10	SF12	1
1 h	50	SF12	2

*\*The maximum number of variables for each package depends on their format. The indicated value refers to the real time variables (such as voltage, current, power); with hour counter variables (such as energy) that value has to be halved.*

*Note: The SF11 spreading factor, unlike the SF12, reduces the distance and the resilience to interferences of the signal. This reduction is more evident with spreading factors inferior to SF11.*



**Frequencies (Europe model UWPM1UL1X)**

Name	Type	Channel (MHz)	Bandwidth (MHz)	Band	Band duty cycle (%)
FA	Base	868.100	125	M-B1	1
FB	Base	868.300	125	M-B1	1
FC	Base	868.500	125	M-B1	1
F1	Custom	869.900	125	R-B4	1
F2	Custom	867.100	125	L-B0	1
F3	Custom	867.300	125	L-B0	1
F4	Custom	867.500	125	L-B0	1

**Frequencies (US model UWPM1UL2X)**

Name	Type	Channel (MHz)	Bandwidth (MHz)
F64	Standard	903.000	500
F65	Standard	904.600	500
F66	Standard	906.200	500
F67	Standard	907.800	500
F68	Standard	909.400	500
F69	Standard	911.000	500
F70	Standard	912.600	500

## Connection Diagrams

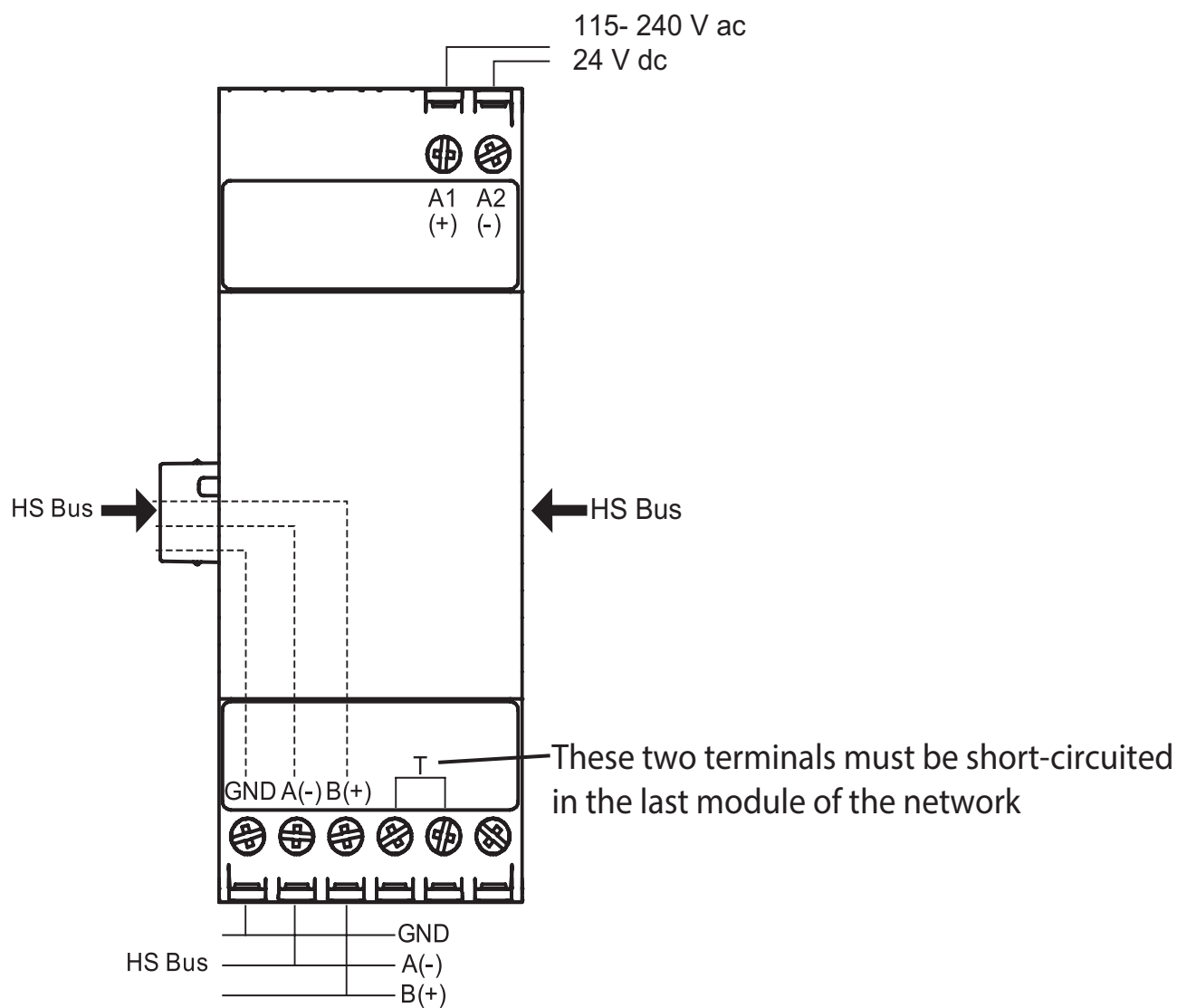

## References





### Further reading

Document	Where to find it
Guidelines	<a href="http://www.productselection.net/Pdf/UK/UWP-A-M-Guidelines.pdf">www.productselection.net/Pdf/UK/UWP-A-M-Guidelines.pdf</a>
Instruction manual	<a href="http://www.productselection.net/MANUALS/UK/UWPM_im.pdf">www.productselection.net/MANUALS/UK/UWPM_im.pdf</a>

### CARLO GAVAZZI compatible components

Purpose	Component name/code key	Notes
Universal web platform	UWP 3.0	See relevant datasheet
Europe wireless endpoint gateway	UWPA	See relevant datasheet

### Conformity

<b>Directives</b>	For UWPM1UL1X	<ul style="list-style-type: none"> <li>• 2014/53/EU (RED)</li> <li>• 2011/65/EU + 2015/863/EU (RoHS)</li> </ul>
	For UWPM1UL2X	<ul style="list-style-type: none"> <li>• FCC Rules Part 15</li> <li>• ISED compliance statements: ICES-003 / NMB 003</li> <li>• Radio compliance for Mexico: NOM-208-SCFI-2016</li> <li>• 2011/65/EU + 2015/863/EU (RoHS)</li> <li>• 2014/35/EU (LVD)</li> </ul>
<b>Standards</b>	<ul style="list-style-type: none"> <li>• Electromagnetic compatibility (EMC) - Immunity EN61000-6-2</li> <li>• Electromagnetic compatibility (EMC) - Emission EN61000-6-3</li> <li>• EN60950-1</li> <li>• ETSI EN 300 220-1</li> <li>• ETSI EN 300 220-2</li> <li>• EN62479</li> <li>• UL standard compliance: 60950-1</li> <li>• Electrical safety for Mexico: NOM-019-SCFI-1998</li> </ul>	
<b>Approvals</b>	UWPM1UL1X and UWPM1UL2X	 
	UWPM1UL2X only	 

## How to order

### UWPA

Code	Description
<b>UWPAM1US1L1X</b>	Europe wireless endpoint gateway
<b>UWPAM1US1L2X</b>	USA wireless endpoint gateway

### UWPM

Code	Description
<b>UWPMM1UL1X</b>	Europe master concentrator gateway
<b>UWPMM1UL2X</b>	USA master concentrator gateway

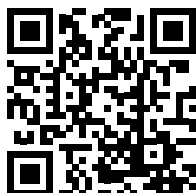

COPYRIGHT ©2021  
Content subject to change. Download the PDF: [www.productselection.net](http://www.productselection.net)