

GPS3 click™

1. Introduction

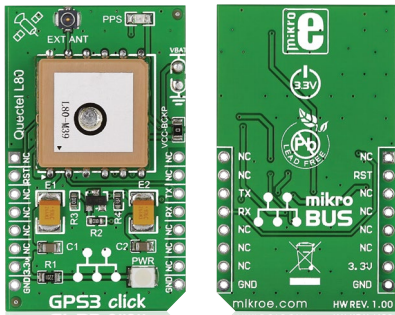

GPS3 click™ carries **Quoctel's L80**, a high-sensitivity ultra slim **GPS module** with a patch antenna. With it, you can add GPS functionality to your design without the need for an external antenna (although the click™ board has a connector for one should you require it). An onboard red LED will blink to indicate successful satellite acquisition. GPS3 click™ communicates with the target board through **mikroBUS™** UART (RX, TX) and RST lines. The board is designed to use a 3.3V power supply.

2. Soldering the headers

Before using your click™ board, make sure to solder 1x8 male headers to both left and right side of the board. Two 1x8 male headers are included with the board in the package.

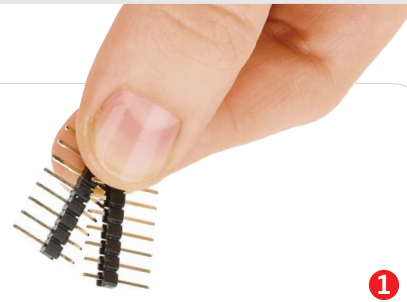

1

2

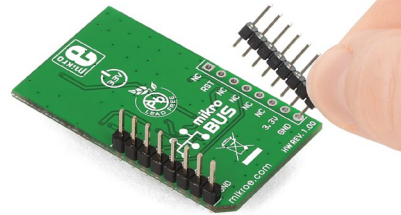

Turn the board upside down so that the bottom side is facing you upwards. Place shorter pins of the header into the appropriate soldering pads.

3

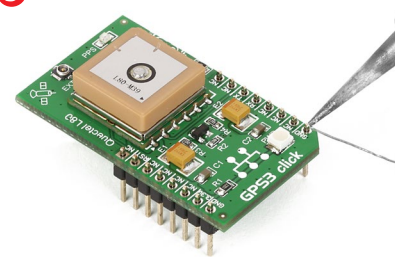

Turn the board upward again. Make sure to align the headers so that they are perpendicular to the board, then solder the pins carefully.

3. Plugging the board in

Once you have soldered the headers your board is ready to be placed into the desired mikroBUS™ socket. Make sure to align the cut in the lower-right part of the board with the markings on the silkscreen at the mikroBUS™ socket. If all the pins are aligned correctly, push the board all the way into the socket.

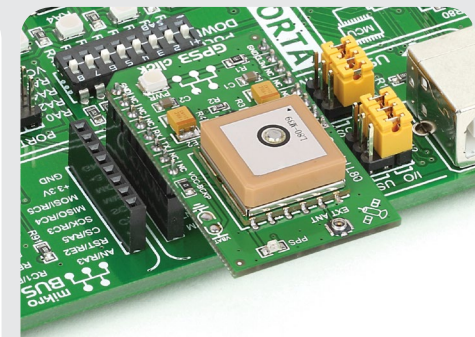
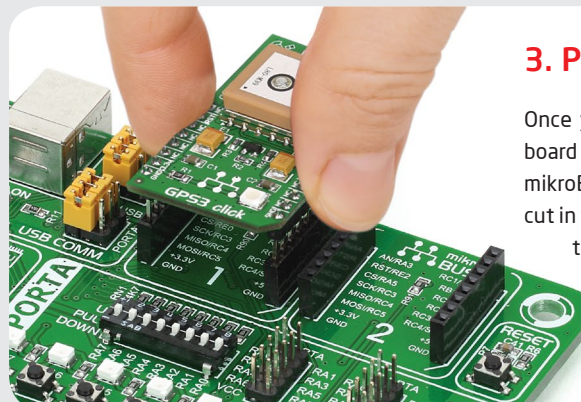

4. Essential features

The L80 module aboard GPS3 click™ incorporates several technologies that enhance the GPS performance. **EASY™** Technology ensures that L80 can calculate and predict orbits automatically using data stored in its internal flash memory. **AlwaysLocate™** technology adaptively adjusts the on/off time to balance between positioning accuracy and power consumption. The **Automatic antenna switching** function enables switching between the internal patch antenna and the external active antenna, keeping positioning during the switching process.



5. GPS3 click™ board schematic

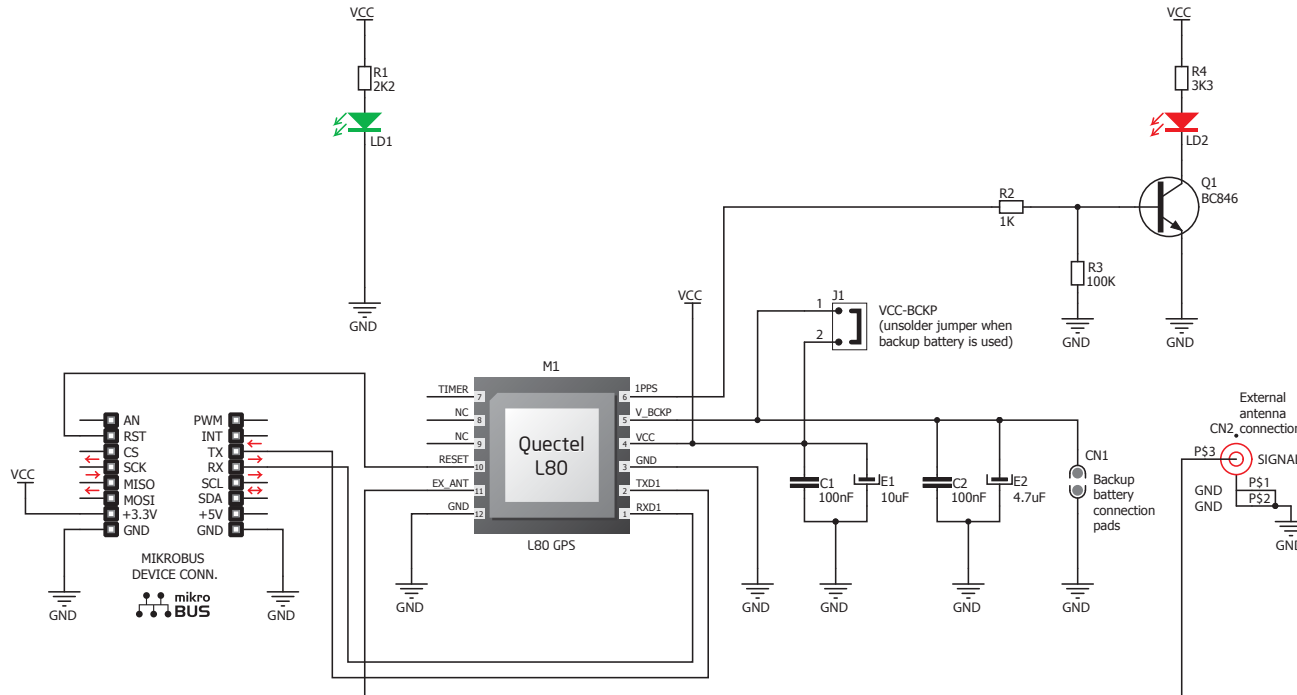

6. External antenna connector

GPS3 click™ has a connector for an external active antenna that could be used alongside, or instead of the patch antenna that's already on the module. To get one, search for "GPS antenna" at www.mikroe.com/store



7. Code examples

Once you have done all the necessary preparations, it's time to get your click™ board up and running. We have provided examples for mikroC™, mikroBasic™ and mikroPascal™ compilers on our **Libstock** website. Just download them and you are ready to start.



8. Support

MikroElektronika offers **free tech support** (www.mikroe.com/support) until the end of the product's lifetime, so if something goes wrong, we're ready and willing to help!