

Technical Information

Liquipoint T FTW31, FTW32

Conductive

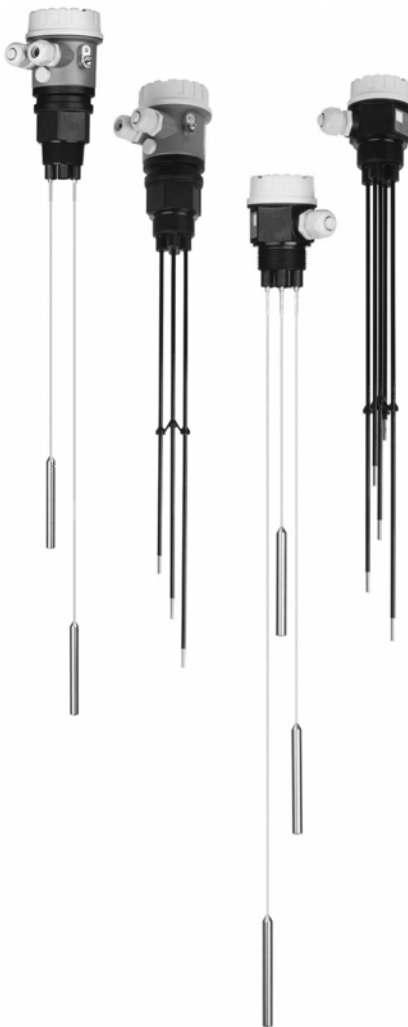

Point level switch for multiple point detection in conductive liquids

Applications

The Liquipoint T is used for point level measurement in conductive liquids (from 10 $\mu\text{S}/\text{cm}$). Depending on the number of measuring points (up to 5 rods or ropes), measuring tasks such as overflow protection, dry running protection, two-point control of pumps or multiple point detection can be implemented.

Your benefits

- Detect up to five point levels with one probe
- Two-point control and additional MAX and MIN detection
- Option between rod or rope version for optimum adaptation to the application
- Flexible instrumentation:
 - with built-in electronic insert, either transistor (PNP) or relay output
 - for connection to a separate transmitter power supply unit
- No adjustment required; standard setting for the most common conductive liquids
- No moving parts in the tank:
 - long service life
 - reliable operation with no wear or blockages
- WHG approval
- Easy adaptation to different conductivities

Table of contents

Function and system design	3	Mechanical construction	17
Measuring principle	3	Weights	17
Measuring system	3	Material	17
		Fitted electrodes	18
Input	5	Human interface	19
Measured variable	5	Operating elements	19
Measuring range (application)	5	Display elements	19
Input signal	5		
Output	5	Certificates and approvals	20
Electronic insert FEW52 (DC-PNP)	5	CE mark	20
Electronic insert FEW54 (relay)	6	Overfill protection	20
Electronic insert FEW58 (NAMUR)	8	Other standards and guidelines	20
Cable monitoring	8	RoHS	20
		RCM-Tick marking	20
Power supply	9	Ex-approvals	20
Compact instrument version with FEW52	9	Type of protection	20
Compact instrument version with FEW54	10		
Compact instrument version with FEW58	11	Ordering information	21
Separate instrumentation for probes with two rods or ropes with cable monitoring	11	Ordering information	21
Separate instrumentation for probes with three rods or ropes with cable monitoring	12	Accessories	21
Separate instrumentation for probes with five rods or ropes with cable monitoring	12	Liquipoint T	21
Cable entry	13	Documentation	22
Cable specifications	13	Operating Instructions	22
		Certificates	22
Performance characteristics	13		
Reference operating conditions	13		
Measuring error	13		
Non-repeatability	13		
Hysteresis	13		
Switch-on delay	13		
Influence of ambient temperature	13		
Installation	13		
Mounting location	13		
Orientation of probes	14		
Example applications	14		
Environment	15		
Ambient temperature range	15		
Storage temperature	15		
Climate class	15		
Degree of protection	15		
Shock resistance	15		
Vibration resistance (at min. rod length)	15		
Electromagnetic compatibility	15		
Process	16		
Conductivity	16		
Limiting medium pressure range	16		
Environment	16		

Function and system design

Measuring principle

An alternating voltage exists between the probe rods. As soon as a conductive liquid creates a connection between the ground probe rod and, for example, the MAX probe rod, a measurable current flows and the Liquipoint T switches.

With point level detection, the device switches back as soon as the liquid clears the MIN probe.

With two-point control, the device does not switch back until the MAX and MIN probe is cleared.

Using alternating voltage prevents corrosion of the probe rods and electrolytic destruction of the product.

The material used for the tank walls is not relevant for measurement because the system is designed as a closed, potential-free circuit between the probe rods and the electronics.

There is absolutely no danger if the probe rods are touched during operation.

Measuring system

Probes without an integrated electronic insert (separate instrument version) for one- or two-point detection

The measuring system consists of:

- FTW31, FTW32 with two/three rods or ropes
- One or two Nivotester FTW325
- Control units, switches or signal transmitters, e.g. process control systems PLC, relays, etc.

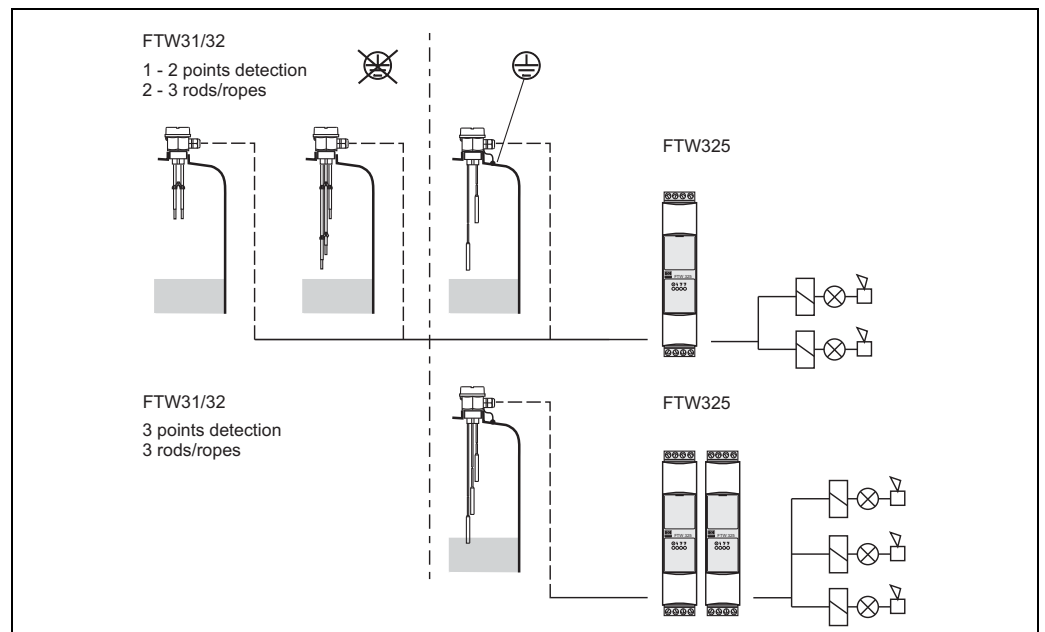

Switch points, depending on the tank material

Probes without integrated electronic insert for multiple point detection

The measuring system consists of:

- FTW31, FTW32 with five rods or ropes
- Two or three Nivotester FTW325
- Control units, switches or signal transmitters, e.g. process control systems PLC, relays, etc.

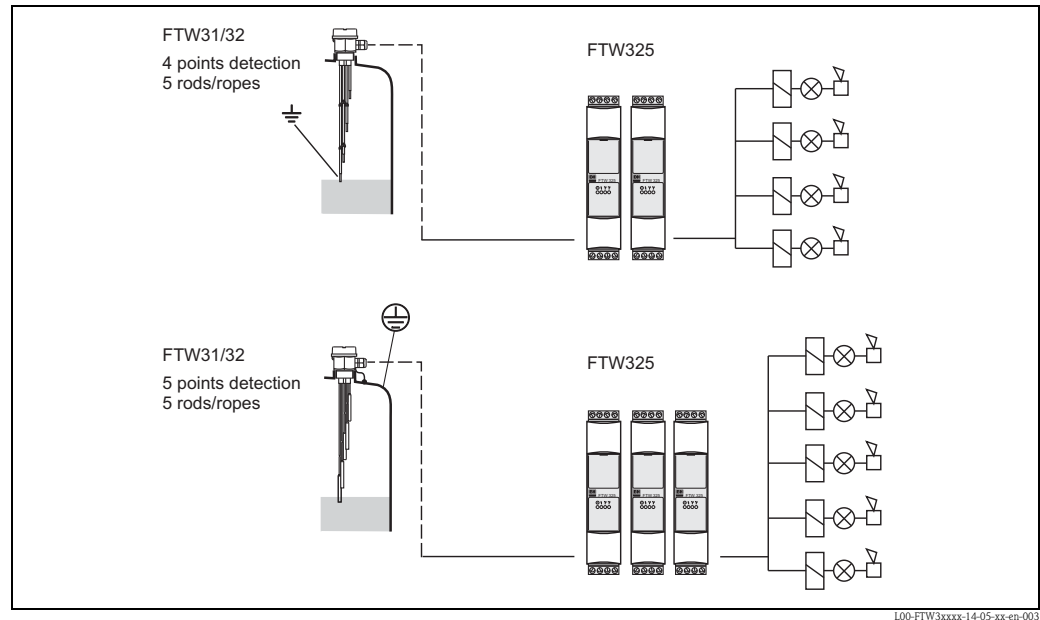

Switch points, depending on the tank material

Probes with integrated electronic insert (compact instrument version)

The measuring system consists of:

- FTW31 with rods or FTW32 with ropes and an electronic insert
- Control units, switches or signal transmitters, e.g. process control systems PLC, relays, etc.

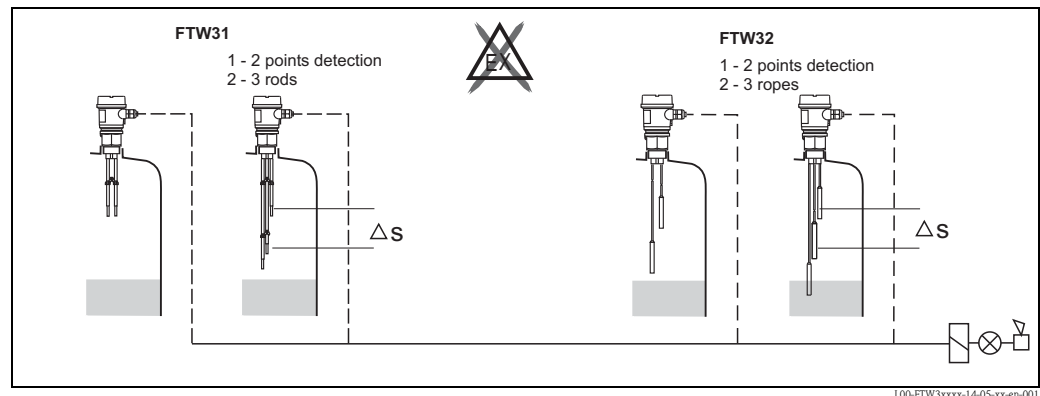

Independent of the tank material



Note!

The compact instrument version with three rods or ropes is always operated in ΔS mode.

Input

Measured variable	Resistance change between two conductors caused by the presence or absence of a conductive liquid.
Measuring range (application)	The measuring range is dependent on the mounting location of the probes. Rod probes can have a max. length of 4 m (13 ft), and rope probes can have a max. length of 15 m (49 ft).
Input signal	Probes covered => a measurable current is flowing between the probes. Probes uncovered => there is no measurable current flowing between the probes.

Output

Electronic insert FEW52 (DC-PNP)







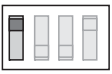
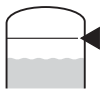

Output signal

Three-wire direct current version

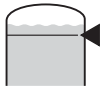
Preferred in conjunction with programmable logic controllers (PLC).

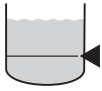
Positive signal at the switch output of the electronics (PNP).

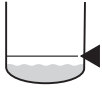
The output is blocked after the point level is reached.

Fail-safe mode	Switch point	Output signal	rd
MAX 		^{*1} $L+$ $1 \xrightarrow{I_L} 3$	^{*3} 
		^{*2} $1 \xrightarrow{< 100 \mu A} 3$	^{*4} 
MIN 		$L+$ $1 \xrightarrow{I_L} 3$	
		$+ < 100 \mu A$ $1 \xrightarrow{} 3$	

L00-FTW3xxxx-15-05-xx-en-001

^{*1} = Load current (connected); ^{*2} Residual current (disconnected); ^{*3} LED not lit; ^{*4} LED lit
See also "Output signal" → 5.

If the probe is covered and the red LED flashes continuously, the sensitivity setting is too high. To ensure a safe switch status even if the conductivity of the medium varies slightly, reduce the sensitivity setting.

Fail-safe mode

Selecting the correct fail-safe mode ensures that the output always runs in quiescent current fail-safe.

- **MAX fail-safe mode (MAX):** The output voltage is 0 V if the switch point is exceeded (probe covered), a fault occurs or the power supply fails.
- **MIN fail-safe mode (MIN):** The output voltage is 0 V if the switch point is undershot (probe uncovered), a fault occurs or the power supply fails.

Switching delay

A switching delay of 2.0 s can be activated or deactivated via a DIL switch.

If the switching delay is set to 0 s, the device switches after approx. 0.3 s.

Sensitivity

The device operates in one of four sensitivity levels (100 Ω, 1 kΩ, 10 kΩ or 100 kΩ). The sensitivity level is set using two DIL switches (SENS). Setting on delivery: 100 kΩ (maximum sensitivity).

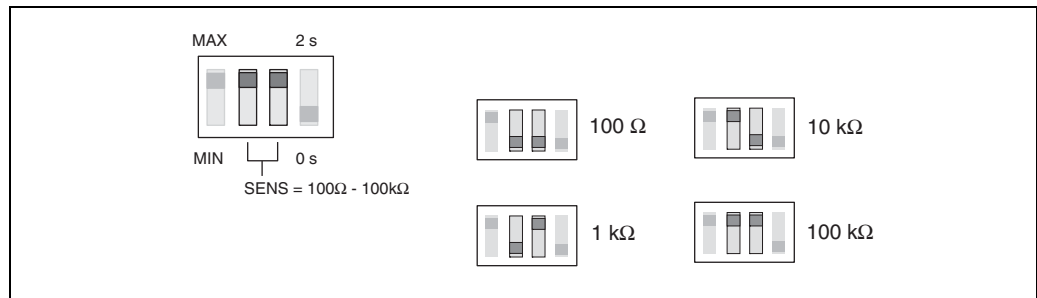

L00-FTW3xxxx-15-05-xx-xx-001

Signal on alarm

In the event of a power failure or a damaged probe: < 100 μA

Load

- Load is switched via a transistor (PNP).
- Cycled overload and short-circuit protection, continuous ≤200 mA (short-circuit proof)
- Residual voltage at transistor at I_{max}: <2.9 V

Electronic insert FEW54 (relay)

Output signal

AC/DC connection with relay output

Both relay contacts switch simultaneously.

Fail-safe mode	Switch point	Output signal	rd
MAX 		*1 3 4 5 6 7 8	*3
		*2 3 4 5 6 7 8	*4
MIN 		*1 3 4 5 6 7 8	*3
		*2 3 4 5 6 7 8	*4

L00-FTW3xxxx-15-05-xx-xx-002

*1 = Relay energized; *2 Relay de-energized; *3 LED not lit; *4 LED lit
See also "Power supply" → 9.

If the probe is covered and the red LED flashes continuously, the sensitivity setting is too high. To ensure a safe switch status even if the conductivity of the medium varies slightly, reduce the sensitivity level.

Fail-safe mode

Selecting the correct fail-safe mode ensures that the relay always runs in quiescent current fail-safe.

- **MAX safety (MAX):** The relay de-energizes when the switch point is exceeded. (probe covered), a fault occurs or the power supply fails.
- **MIN safety (MIN):** The relay de-energizes when the switch point is undershot. (probe uncovered), a fault occurs or the power supply fails.

Sensitivity

The device operates in one of four sensitivity levels (100 Ω, 1 kΩ, 10 kΩ or 100 kΩ).

The sensitivity level is set using 2 DIL switches (SENS).

Setting on delivery: 100 kΩ (maximum sensitivity)

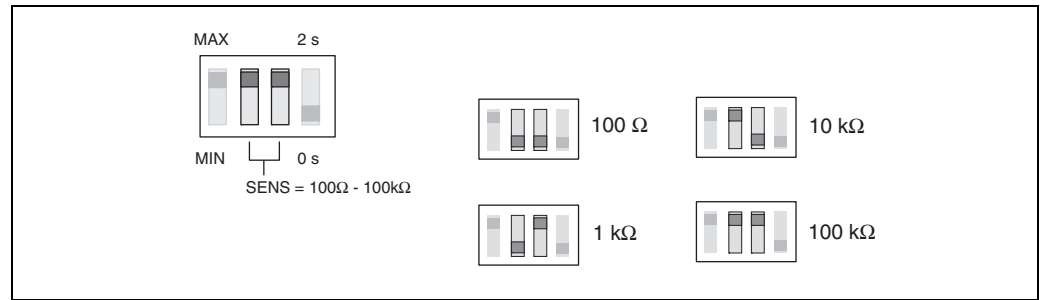

Switching delay

A switching delay of 2.0 s can be activated or deactivated via a DIL switch.

If the switching delay is set to 0 s, the device switches after approx. 0.3 s.

Signal on alarm

Output signal in the event of a power failure or a damaged probe: relay de-energized.

Load

Loads are switched via 2 potential-free change-over contacts.

I~ max. 4 A, U~ max. 253 V;

P~ max. 1000 VA, $\cos \varphi = 1$, P~ max. 700 VA, $\cos \varphi > 0.7$;

I- max. 4 A to 30 V, I- max. 0.2 A to 150 V.

When connecting a functional extra-low voltage circuit with double insulation in accordance with IEC 1010: the sum of the relay output and power supply voltages is max. 300 V.

Galvanic isolation



All input channels, output channels and relay contacts are galvanically isolated from each other.

Electronic insert FEW58 (NAMUR)













Output signal

For connecting to isolating amplifiers acc. to NAMUR (IEC 60947-5-6) e.g. Nivotester FTL325N from Endress+Hauser.

Output signal jump from high to low current on point level (H-L edge).

-  = lit
-  = flashes
-  = unlit

L00-FTL5xxxx-07-05-xx-xx-002

Fail-safe mode	Level	Output signal	LEDs	
			gn	ye
MAX		+ 2.2 ... 6.5 mA → 1		
		+ 0.4 ... 1.0 mA → 1		
MIN		+ 2.2 ... 6.5 mA → 1		
		+ 0.4 ... 1.0 mA → 1		

L00-FTW3xxxx-04-05-xx-xx-004

Fail-safe mode

Selecting the correct fail-safe mode ensures that the relay always runs in quiescent current fail-safe.

- MAX safety (MAX): The output signal is <1.0 mA when the switch point is exceeded (probe covered), a fault occurs or the power supply fails.
- MIN safety (MIN): The output signal is <1.0 mA when the switch point is undershot (probe uncovered), a fault occurs or the power supply fails.

Sensitivity

The device operates in one of four sensitivity levels (100 Ω, 1 kΩ, 10 kΩ or 100 kΩ).

The sensitivity level is set using two DIL switches (SENS).

Setting on delivery: 100 kΩ (maximum sensitivity)

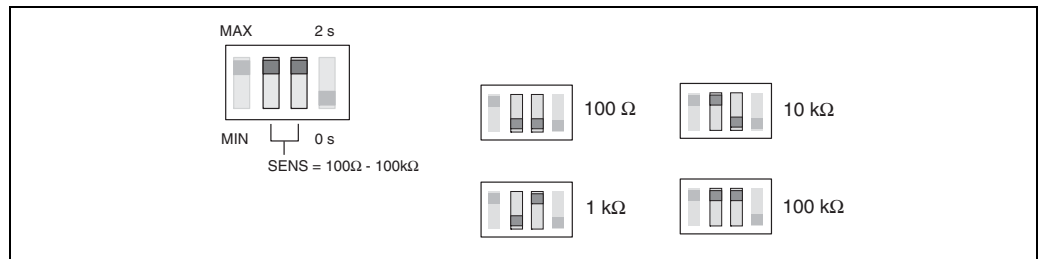

L00-FTW3xxxx-15-05-xx-xx-001

Switching delay

A switching delay of 2.0 s can be activated or deactivated via a DIL switch.

If the switching delay is set to 0 s, the device switches after approx. 0.3 s.

Load

Refer to the "Technical Data" of the connected isolating amplifier acc. to NAMUR (IEC 60947-5-6)

Cable monitoring

For probes without an electronic insert, an additional printed circuit board is installed in the housing to enable cable monitoring. It is always switched or connected between rod/rope 1 and 2.



Note!

When using switching units (transmitters) that do not support cable monitoring, these must be removed.

Power supply

Compact instrument version with FEW52

Transistor circuit for load

The load connected to terminal 3 is switched by a transistor, contactless and therefore without bouncing. In normal switch status, terminal 3 has a positive signal.

The transistor is blocked in the event of a level alarm or a power failure.

Protection against voltage peaks

When connecting a device with high inductance, always connect a voltage limiter.

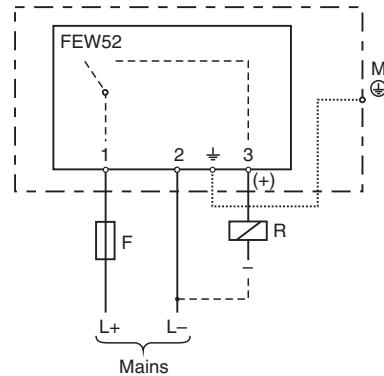

Connecting the FEW52 electronic insert
F: Fine-wire fuse 500 mA, semi-time lag
M: Ground connection to protective earth

L00-FTW3xxxx-04-05-xx-en-001

Supply voltage (FEW52)

- Supply voltage: $U = 10.8 \text{ V to } 45 \text{ V}$
- Load connection: open collector; PNP
- Switching voltage: max. 45 V
- Connected load, continuous: max. 200 mA
- Protected against reverse polarity

Power consumption

$$P < 1.1 \text{ W}$$

Current consumption

$$I < 25 \text{ mA (without load)}$$

**Compact instrument version
with FEW54****Relay contact circuit for load**

The connected load is switched via potential-free relay contacts (change-over contact). In the event of a level alarm or a power failure, the relay contacts break the connections between terminals 3 and 4 and terminals 6 and 7. The relays always switch simultaneously.

Protection against voltage peaks and short-circuits

When connecting a device with high inductance, fit a spark barrier to protect the relay contact. A fine-wire fuse (load-dependent) can protect the relay contact in the event of a short-circuit.

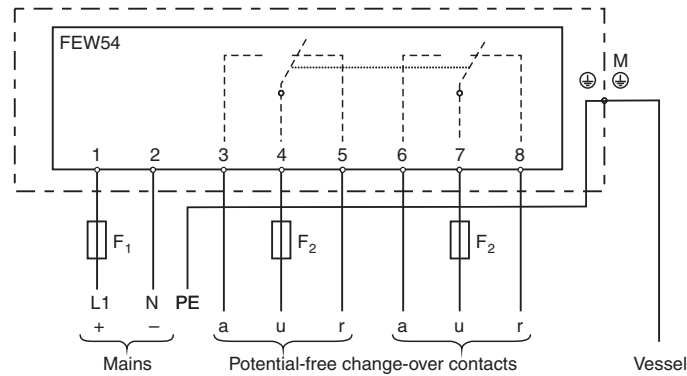

L00-FTW3xxxx-04-05-xx-es-002

Connecting the FEW54 electronic insert

F_1 : Fine-wire fuse 500 mA, semi-time lag

F_2 : Fine-wire fuse to protect the relay contact, load-dependent

M: Ground connection to protective earth (PE)

Supply voltage (FEW54)

- Supply voltage: U_{DC} 20 V to 55 V DC or U_{AC} 20 V to 253 V AC, 50/60 Hz
- Peak inrush current: max. 2 A, max. 400 μs
- Output: two potential-free change-over contacts
- Contact load capacity: U_{AC} max. 253 V, I_{AC} max. 4 A, U_{DC} 30 V/4 A; 150 V/ 0.2 A

Power consumption

$P < 2.0 \text{ W}$

Current consumption

$I < 60 \text{ mA}$

Compact instrument version with FEW58

To be used with a separate switching unit acc. to IEC 60947-5-6 (NAMUR) e.g. Nivotester FTL325N from Endress+Hauser; Output signal jump from high to low current on point level (H-L edge).

Signal transmission on a two-wire line:
H-L-edge 2.2 to 6.5 mA / 0.4 to 1.0 mA

When using a multiplex the cycle time must be set to a minimum of 2 s.

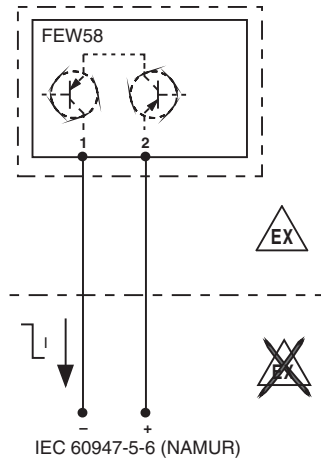

Connecting the FEW58 electronic insert

L00FTW3xxxx-04-05-xx-en-005.eps

Supply voltage (FEW58)

Refer to the "Technical Data" of the connected isolating amplifier acc. to IEC 60947-5-6 (NAMUR) e.g. Nivotester FTL325N from Endress+Hauser.

Signal on alarm

Output signal with damaged sensor: < 1.0 mA

Separate instrumentation for probes with two rods or ropes with cable monitoring

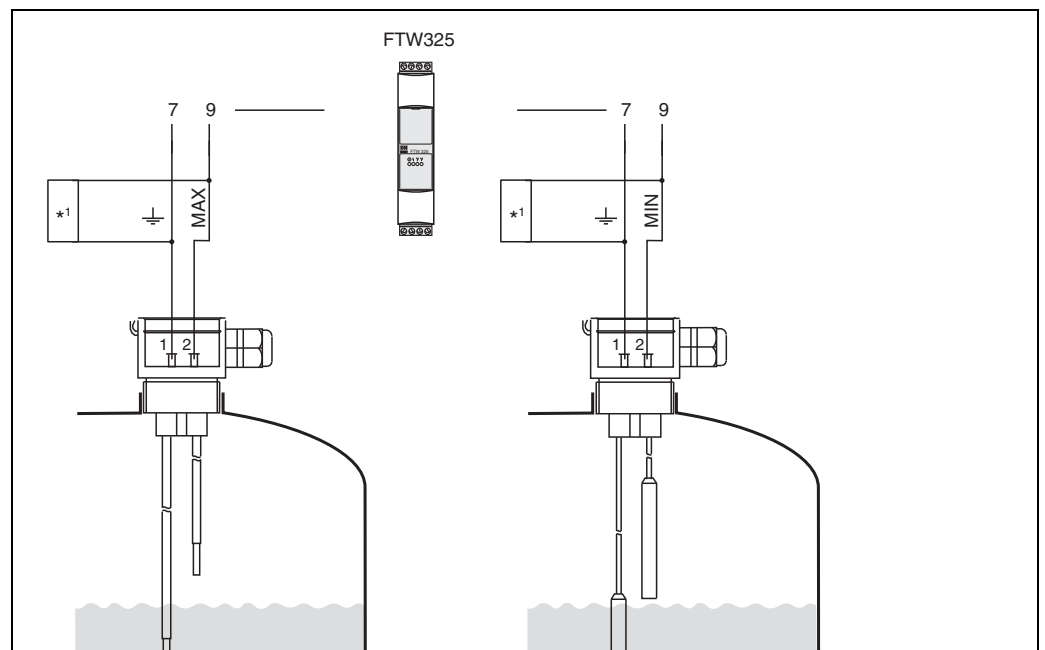

L00-FTW3xxxx-04-05-xx-en-003

*1 Printed circuit board for cable monitoring (only required for probes with WHG certification.)
The power supply and evaluation are provided by switching units, e.g. Nivotester FTW325

Separate instrumentation for probes with three rods or ropes with cable monitoring

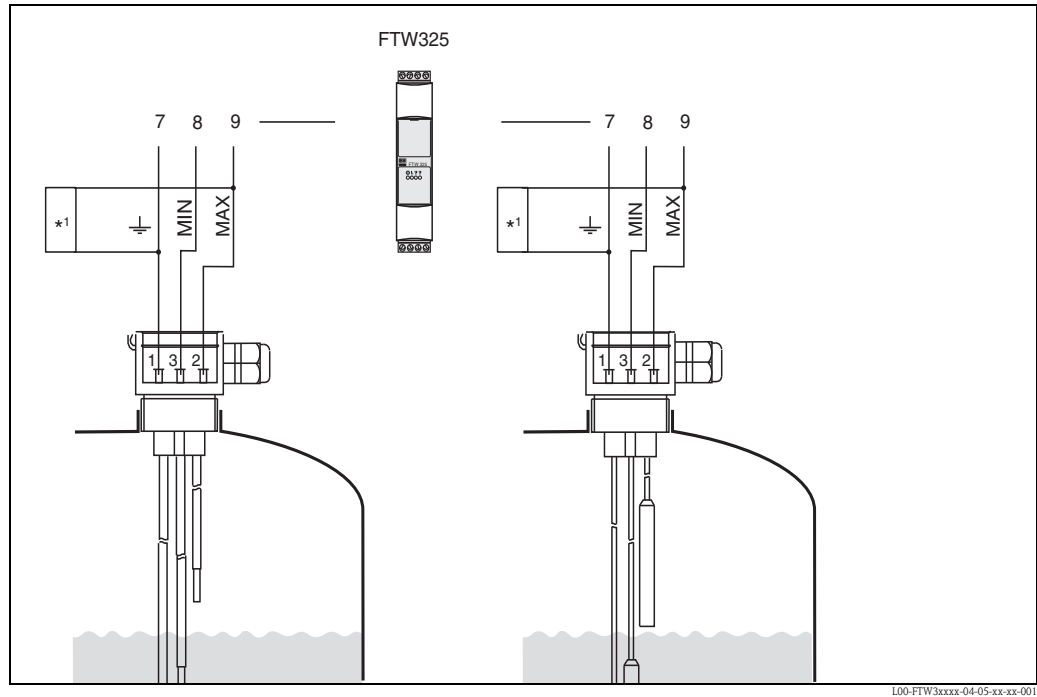

*1 Printed circuit board for cable monitoring (only required for probes with WHG certification.)
The power supply and evaluation are provided by a switching unit, e.g. Nivotester FTW325

Separate instrumentation for probes with five rods or ropes with cable monitoring

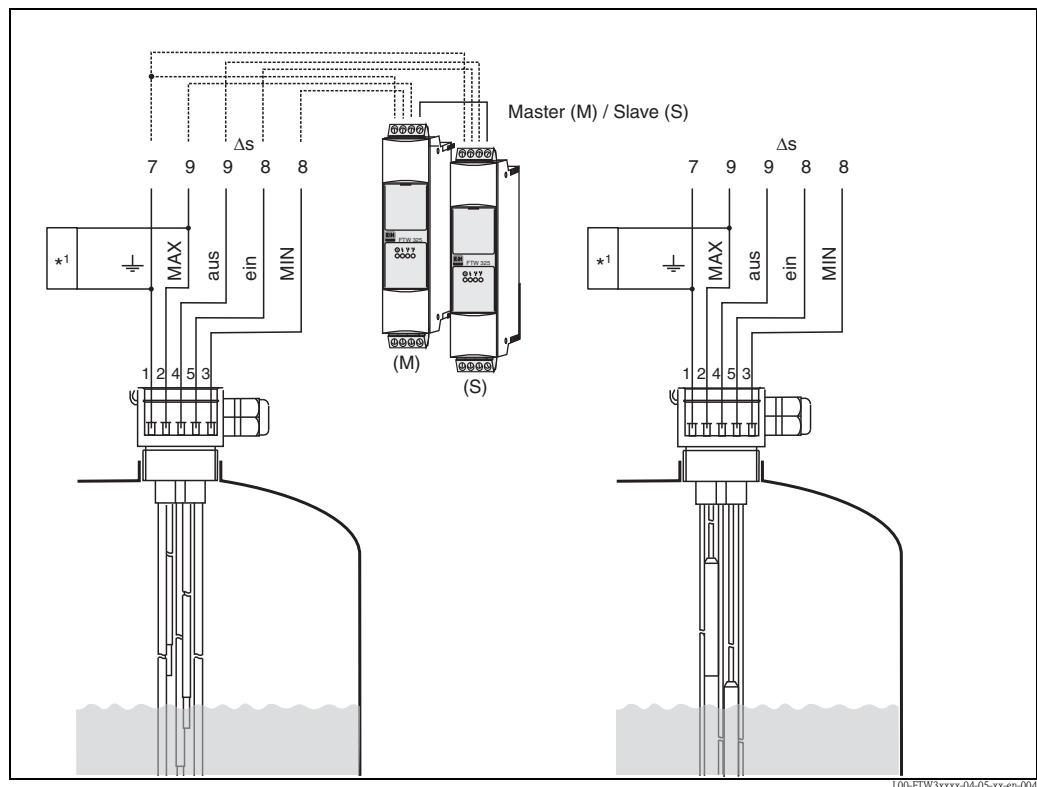

*1 Printed circuit board for cable monitoring (only required for probes with WHG certification.)
The power supply and evaluation are provided by a switching unit, e.g. Nivotester FTW325

Cable entry	M 20x1.5 and NPT 1/2 " <ul style="list-style-type: none"> ■ Quantity in F24 housing: 1 (separate instrument version) ■ Quantity in F16 housing: 2 (compact instrument version) ■ Conductor cross-section (including wire end sleeve): 2.5 mm² (14 AWG)
--------------------	---

Cable specifications	Use a commercially available cable (25 Ω per wire).
-----------------------------	---

Performance characteristics



Note!
When electronic insert is installed!

Reference operating conditions	<ul style="list-style-type: none"> ■ Ambient temperature: 23 °C (73 °F) ■ Medium temperature: 23 °C (73 °F) ■ Medium viscosity: medium must release the probe again (drain off). ■ Medium pressure p_e: 0 bar (0 psi) ■ Probe installation: vertically from above
---------------------------------------	---

Measuring error	$\pm 10\%$ at 100 Ω - 100 kΩ $\pm 5\%$ at 1 kΩ - 10 kΩ
------------------------	---

Non-repeatability	$\pm 5\%$ at 100 Ω - 100 kΩ $\pm 1\%$ at 1 kΩ - 10 kΩ
--------------------------	--

Hysteresis	- 10% for the MAX probe, in reference to the switch point. Δs function disabled.
-------------------	--

Switch-on delay	< 3 s
------------------------	-------

Influence of ambient temperature	< 0.05 %/K
---	------------

Installation

Mounting location	Tanks The rod and rope probes are mounted predominantly in tanks.
--------------------------	---

Piping (partially filled)

Two-rod probes can be used in piping as, for example, dry running protection for pumps.

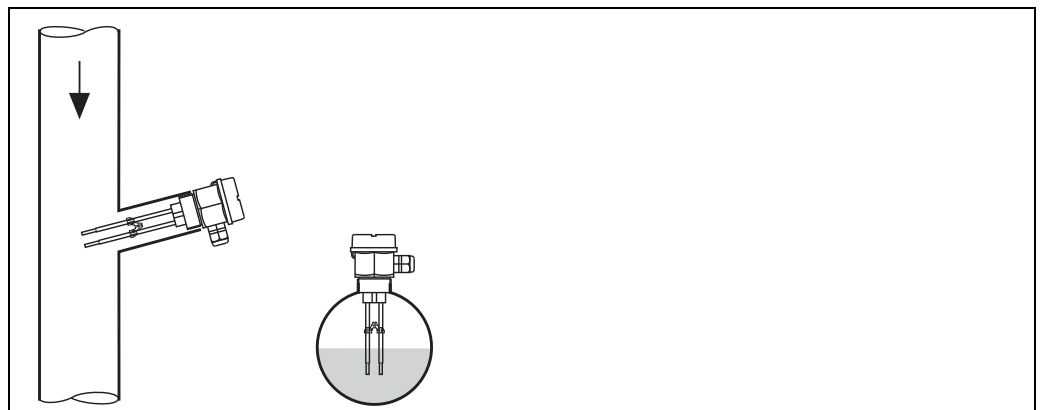

100-FTW3xxxx-11-05-xx-xx-001

Orientation of probes

Point level detection

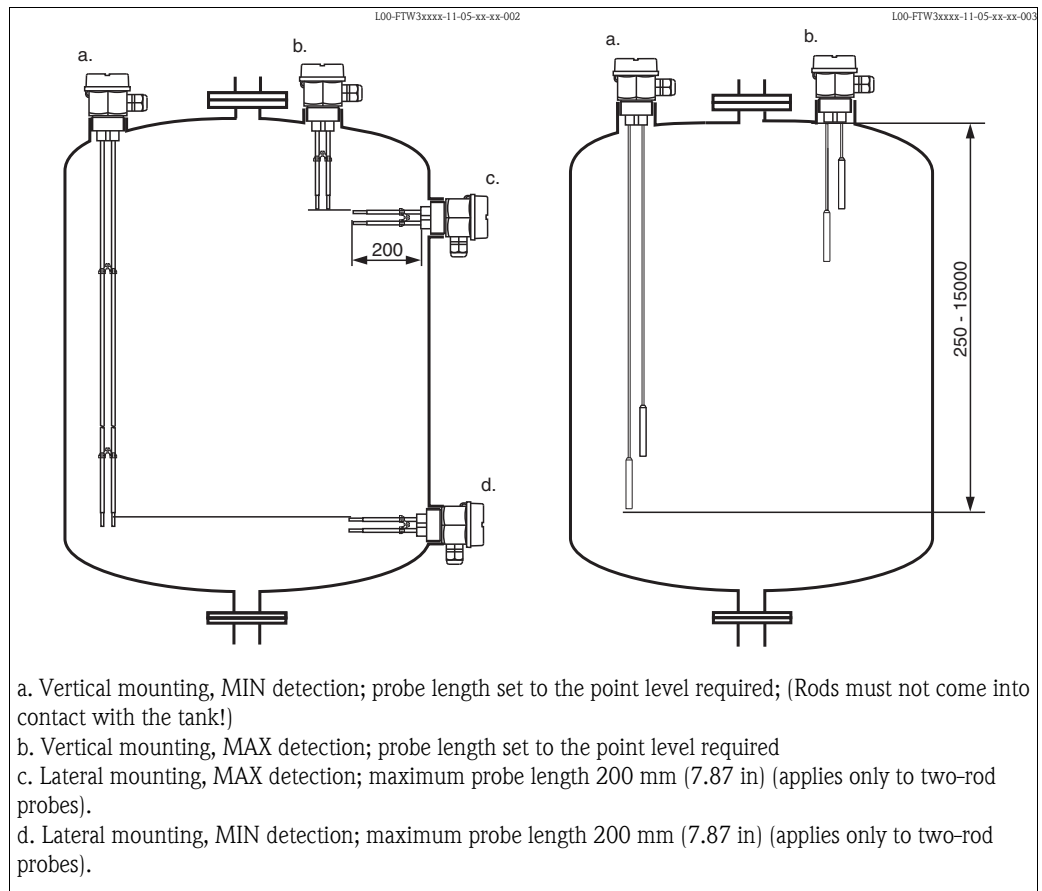

Example applications

Point level detection: Two-point control (Δs)

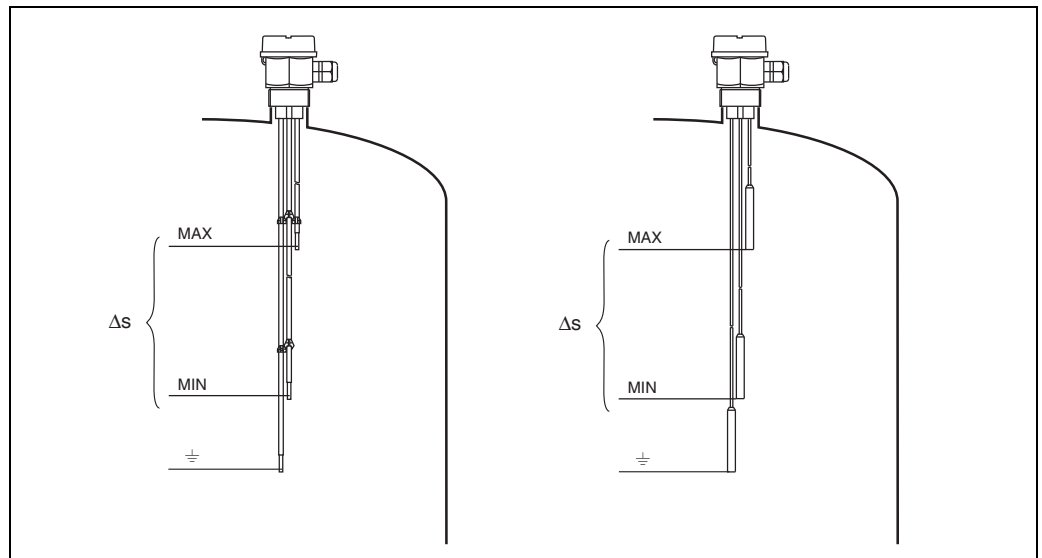

Two-point control (Δs) e.g. pump control

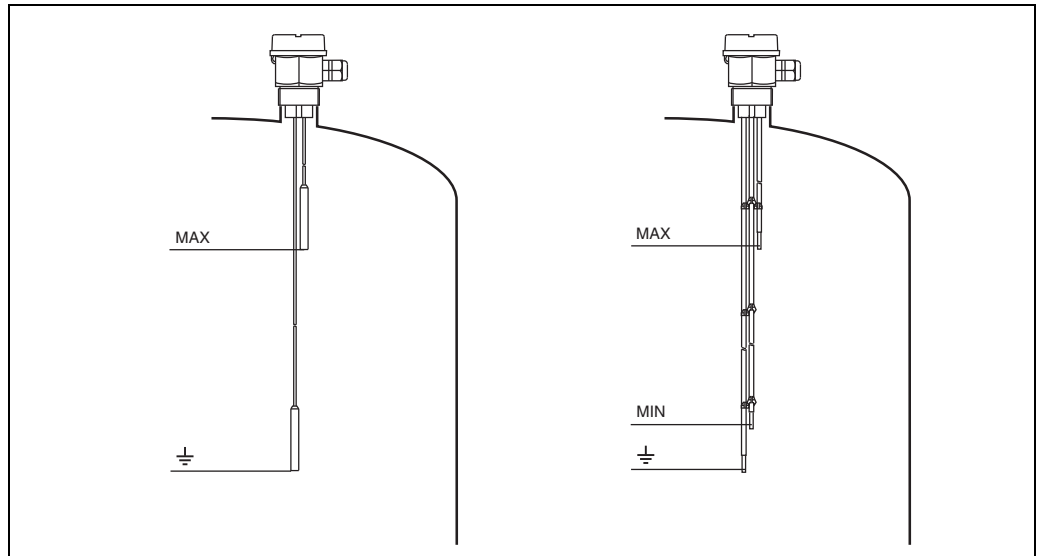
Point level detection: MAX and MIN detection

L00-FTW3xxxx-15-05-xx-xx-003

Point level detection (MAX),
MAX and MIN detection for compact instrument version only possible with Δs.

Environment

Ambient temperature range	Non-hazardous area <ul style="list-style-type: none"> ■ -40 to 70 °C (-40 to 158 °F) ■ -40 to 60 °C (-40 to 140 °F) for FEW58 NAMUR
Storage temperature	-40 to 80 °C (-40 to 176 °F)
Climate class	Tropicalized as per DIN EEC 68, part 2-38
Degree of protection	IP66
Shock resistance	Practical test
Vibration resistance (at min. rod length)	DIN 60068-2-64 / IEC 68-2-64: 20 to 2000 Hz, 1 (m/s ²) ² /Hz
Electromagnetic compatibility	<ul style="list-style-type: none"> ■ Interference Emission to EN 61326, Electrical Equipment Class B Interference Immunity to EN 61326, Annex A (Industrial) ■ Use for separate-instrumented probes a screened cable between the probe and the switching unit. For installation instructions for screened cables and general instructions for EMC inspection conditions for E+H devices, see also TI00241F.

Process

Conductivity $\geq 10 \mu\text{S}$

Limiting medium pressure range -1 to 10 bar (-1 psi)

Environment Permissible ambient temperature T_1 at the housing as a function of the measuring material temperature T_2 in the vessel:

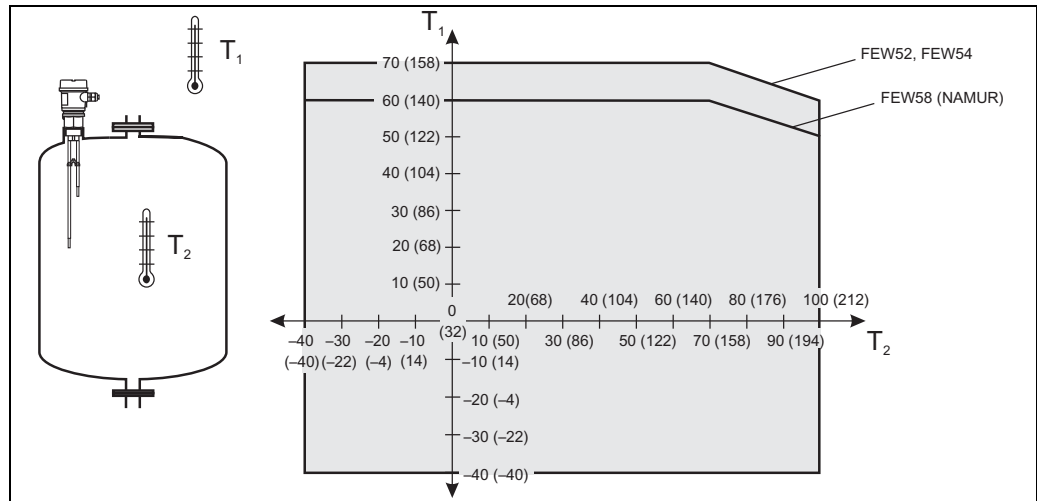

Note!
For separately instrumented devices (without FEW5x) there are no restrictions in the indicated temperature range.

Mechanical construction



Note!

All dimensions in mm (in)!

Design	Designation	Housing with electronic insert		Housing without electronic insert		
		Dimensions G 1 1/2	Dimensions NPT 1 1/2	Dimensions G 1 1/2	Dimensions NPT 1 1/2	
	A	85 (3.35)		66 (2.6)		
	B	76 (2.99)		64 (2.52)		
	C	145 (5.71)	168 (6.61)	64 (2.52)	86 (3.39)	
	D - across flats	55 (2.17)		55 (2.17)		
	E	22 (0.87)	23.5 (0.93)	22 (0.87)	23.5 (0.93)	
	F	15 (0.59)		15 (0.59)		
	G - Probe length rod - Probe length rope	100 to 4000 (3.94 to 157) 250 to 15000 (9.84 to 591)		100 to 4000 (3.94 to 157) 250 to 15000 (9.84 to 591)		

Weights

Separate instrument version	2, 3 or 5 probes
Rod 1 m (3.3 ft) length	415 g, 530 g, 760 g (14.64 oz, 18.69 oz, 26.81 oz)
Rope 1 m (3.3 ft) length	390 g, 470 g, 640 g (13.76 oz, 16.58 oz, 22.57 oz)
Compact instrument version	2 or 3 probes
Rod 1 m (3.3 ft) length	600 g, 720 g (21.16 oz, 25.40 oz)
Rope 1 m (3.3 ft) length	710 g, 800 g (25.04 oz, 28.22 oz)

Material

Wetted

- Seal between probe rod/probe rope and process connection: EPDM
- Spacer: PP
- Flat seal for process connection: elastomer fiber, (asbestos-free)
- Process connections:
 - G 1 1/2: PPS
 - NPT 1 1/2: PPS

Probe rods

- Rod: 316L (1.4404) or carbon fiber
- Insulation: PP

Probe ropes

- Rope: 316Ti (1.4571)
- Insulation: FEP
- Weight: 316L (1.4435)

Not wetted

- Plastic housing F24 (separate instrument version)
 - Housing: PPS
 - Cover: PBT
- Polyester housing F16: PBT-FR with PBT-FR cover or with PA12 transparent cover,
 - Cover seal: EPDM
 - Adapter: PBT-FR
 - Nameplate, glued: polyester foil (PET)
 - Pressure compensation filter: PBT-GF20
- Ground terminal on housing (outside): 304 (1.4301)
- Cable gland: polyamide (PA)

Fitted electrodes**Rod probes**

Compact instrument version: 2 or 3 rods; Separate instrument version: 2, 3 or 5 rods

- Diameter without insulation: 4 mm (0.16 in)
- Maximum rod length: 4000 mm (157 in)
- Minimum rod length: 100 mm (3.94 in)
- Thickness of insulation: 0.5 mm (0.02 in)
- Length of non-insulated area (tip of rod): 20 mm (0.79 in)
- Extraction forces (parallel probe rod): 1000 N (224.8 lbf)

Rope probes

Compact instrument version: 2 or 3 rods; Separate instrument version: 2, 3 or 5 rods

- Diameter without insulation: 1 mm (0.04 in)
- Maximum rope length: 15000 mm (591 in)
- Minimum rope length: 250 mm (9.84 in)
- Thickness of insulation: 0.75 mm (0.03 in)
- Weight length: 100 mm (3.94 in) not insulated
- Weight diameter: 10 mm (0.39 in)
- Extraction forces (parallel probe rod): 500 N (112.4 lbf)

Human interface

Operating elements

FEW52, FEW54, FEW58

- One DIL switch for MIN or MAX safety
- One DIL switch for 0 s or 2 s switching delay
- Two DIL switches for setting the sensitivity level 100 Ω, 1 kΩ, 10 kΩ or 100 kΩ

Display elements

Separate instrument version

The display elements are dependent on the connected switching unit.

Compact instrument version

FEW52

- One red light emitting diode: fault message, switch status
- One green light emitting diode: operation

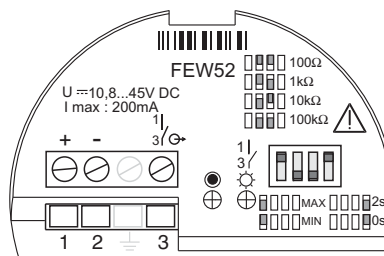

L00-FTW3xxxx-07-05-xx-xx-001

FEW54

- One red light emitting diode: fault message, switch status
- One green light emitting diode: operation

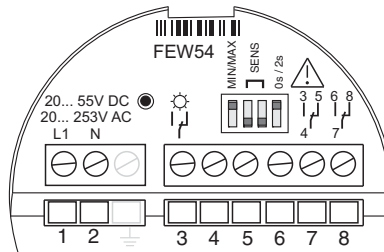

L00-FTW3xxxx-07-05-xx-xx-002

FEW58

- One yellow light emitting diode: fault message, switch status
- One green light emitting diode: operation

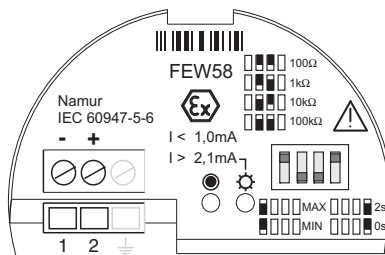

L00-FTW3xxxx-07-05-xx-xx-003

Certificates and approvals

CE mark	The Liquipoint T meets the legal requirements of the EC directives. Endress+Hauser confirms that the device has been successfully tested by applying the CE mark.
Overfill protection	<ul style="list-style-type: none"> ■ WHG, leak test (leakage)
Other standards and guidelines	<ul style="list-style-type: none"> ■ Low voltage equipment directive (73/ 23/ EEC) ■ DIN EN 61010 part 1, 2001 Safety regulations for electrical equipment for measurement, control and laboratory use Part 1: General requirements ■ EN 61326 Electrical equipment for measurement, control and laboratory use EMC requirements
RoHS	The measuring system complies with the substance restrictions of the Restriction on Hazardous Substances Directive 2011/65/EU (RoHS 2).
RCM-Tick marking	The supplied product or measuring system meets the ACMA (Australian Communications and Media Authority) requirements for network integrity, interoperability, performance characteristics as well as health and safety regulations. Here, especially the regulatory arrangements for electromagnetic compatibility are met. The products are labelled with the RCM- Tick marking on the name plate.



A0029501

Ex-approvals	For further information, please contact your local Endress+Hauser Sales Center. All data relevant to explosion protection can be found in separate Ex documentation (see: Documentation → 22) .
---------------------	--

Type of protection	<ul style="list-style-type: none"> ■ [Ex ia] IIC (FEW58) ■ [Ex na/C(L)] IIC (FEW52, FEW54)
---------------------------	--

Ordering information

Ordering information

Detailed ordering information is available as follows:

- In the Product Configurator on the Endress+Hauser website: www.endress.com → Select country → Instruments → Select device → Product page function: Configure this product
- From your Endress+Hauser sales center: www.endress.com/worldwide

Product Configurator - the tool for individual product configuration

- Configuration data updated on a daily basis
- Depending on the device: Direct input of data specific to measuring point, such as measuring range or operating language
- Automatic verification of exclusion criteria
- Automatic generation of order code with breakdown in PDF or Excel output format
- Possibility to order directly from the Endress+Hauser online shop

Accessories

Liquipoint T

Lock nut G 1 1/2"

- Hexagon: AF 60
- Material: PC-FR
- Part number: 52014146

Electronic insert FEW52

- Output PNP 10.8 to 45 V DC
- Part number: 52017271

Electronic insert FEW54

- Output relay 20 to 253 V AC, 20 to 55 V DC
- Part number: 52017272

Electronic insert FEW58

- Output NAMUR (IEC 60947-5-6)
- Part number: 52017273

Documentation



Note!

This documentation can be found on the product pages at "www.endress.com".

Operating Instructions

Liquipoint T FTW31, FTW32
KA00204F/00

Certificates

WHG

- Liquipoint T FTW31, FTW32
ZE00043F/00

ATEX II 3G EEx nA/C(L) IIC T6

- Liquipoint T FTW31, FTW32
XA00226F/00

ATEX II 2G EEx ia IIC T6

- Liquipoint T FTW31, FTW32
XA00230F/00



71336942

www.addresses.endress.com
