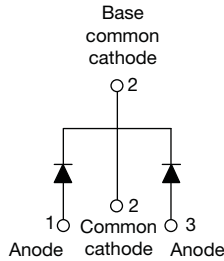
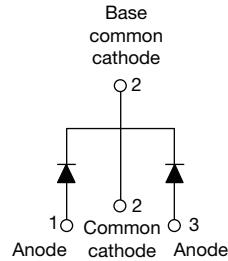

High Performance Schottky Rectifier, 2 x 20 A

D²PAK (TO-263AB)

TO-262AA

VS-40CTQ150SHM3

VS-40CTQ150-1HM3

FEATURES

- Very low forward voltage drop
- 175 °C T_J operation
- Center tap TO-220 package
- High frequency operation
- High purity, high temperature epoxy encapsulation for enhanced mechanical strength and moisture resistance
- Guard ring for enhanced ruggedness and long term reliability
- Meets MSL level 1, per J-STD-020, LF maximum peak of 245 °C
- Meet JESD 201 class 1 whisker test
- AEC-Q101 qualified
- Material categorization: for definitions of compliance please see www.vishay.com/doc?99912



RoHS
COMPLIANT
HALOGEN
FREE

DESCRIPTION

The VS-40CTQ... center tap Schottky rectifier has been optimized for very low forward voltage drop, with moderate leakage. The proprietary barrier technology allows for reliable operation up to 175 °C junction temperature. Typical applications are in switching power supplies, converters, freewheeling diodes, and reverse battery protection.

PRIMARY CHARACTERISTICS

I _{F(AV)}	2 x 20 A
V _R	150 V
V _F at I _F	0.71 V
I _{RM}	15 mA at 125 °C
T _J max.	175 °C
E _{AS}	1 mJ
Package	D²PAK (TO-263AB), TO-262AA
Circuit configuration	Common cathode

MAJOR RATINGS AND CHARACTERISTICS

SYMBOL	CHARACTERISTICS	VALUES	UNITS
I _{F(AV)}	Rectangular waveform	40	A
V _{RRM}		150	V
I _{FSM}	t _p = 5 μs sine	1500	A
V _F	20 A _{pk} , T _J = 125 °C (per leg)	0.71	V
T _J		-55 to +175	°C

VOLTAGE RATINGS

PARAMETER	SYMBOL	VS-40CTQ150SHM3 VS-40CTQ150-1HM3	UNITS
Maximum DC reverse voltage	V _R	150	V
Maximum working peak reverse voltage	V _{RWM}		



ABSOLUTE MAXIMUM RATINGS					
PARAMETER	SYMBOL	TEST CONDITIONS		VALUES	UNITS
Maximum average forward current, see fig. 5	$I_{F(AV)}$	50 % duty cycle at $T_C = 140\text{ }^\circ\text{C}$, rectangular waveform		20	A
				40	
Maximum peak one cycle non-repetitive surge current per leg, see fig. 7	I_{FSM}	5 μs sine or 3 μs rect. pulse	Following any rated load condition and with rated V_{RRM} applied	1500	
		10 ms sine or 6 ms rect. pulse		250	
Non-repetitive avalanche energy per leg	E_{AS}	$T_J = 25\text{ }^\circ\text{C}$, $I_{AS} = 1.5\text{ A}$, $L = 0.9\text{ mH}$		1.0	mJ
Repetitive avalanche current per leg	I_{AR}	Current decaying linearly to zero in 1 μs Frequency limited by T_J maximum $V_A = 1.5 \times V_R$ typical		1.5	A

ELECTRICAL SPECIFICATIONS					
PARAMETER	SYMBOL	TEST CONDITIONS		VALUES	UNITS
Maximum forward voltage drop per leg See fig. 1	$V_{FM}^{(1)}$	20 A	$T_J = 25\text{ }^\circ\text{C}$	0.93	V
		40 A		1.16	
		20 A	$T_J = 125\text{ }^\circ\text{C}$	0.71	
		40 A		0.85	
Maximum reverse leakage current per leg See fig. 2	$I_{RM}^{(1)}$	$T_J = 25\text{ }^\circ\text{C}$	$V_R = \text{Rated } V_R$	50	μA
		$T_J = 125\text{ }^\circ\text{C}$		15	mA
Maximum junction capacitance per leg	C_T	$V_R = 5\text{ V}_{DC}$ (test signal range 100 kHz to 1 MHz), $25\text{ }^\circ\text{C}$		450	pF
Typical series inductance per leg	L_S	Measured lead to lead 5 mm from package body		8.0	nH
Maximum voltage rate of change	dV/dt	Rated V_R		10 000	V/ μs

Note

(1) Pulse width < 300 μs , duty cycle < 2 %

THERMAL - MECHANICAL SPECIFICATIONS					
PARAMETER	SYMBOL	TEST CONDITIONS		VALUES	UNITS
Maximum junction and storage temperature range	T_J, T_{Stg}			-55 to +175	$^\circ\text{C}$
Maximum thermal resistance, junction to case per leg	R_{thJC}	DC operation See fig. 4		1.5	$^\circ\text{C/W}$
Maximum thermal resistance, junction to case per package		DC operation		0.75	
Typical thermal resistance, case to heatsink	R_{thCS}	Mounting surface, smooth and greased		0.5	
Approximate weight				2	g
				0.07	oz.
Marking device		Case style D ² PAK (TO-263AB)		40CTQ150SH	
		Case style TO-262		40CTQ150-1H	

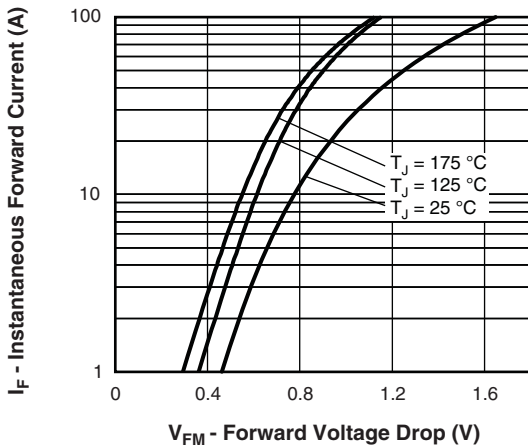

Fig. 1 - Maximum Forward Voltage Drop Characteristics

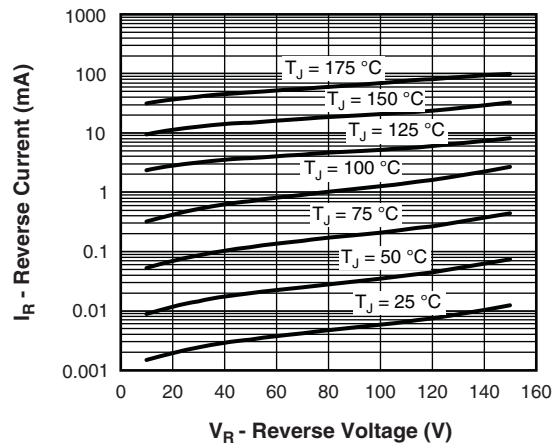

Fig. 2 - Typical Values of Reverse Current vs. Reverse Voltage

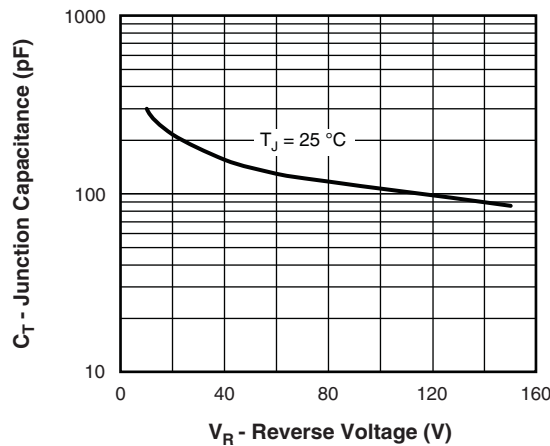

Fig. 3 - Typical Junction Capacitance vs. Reverse Voltage

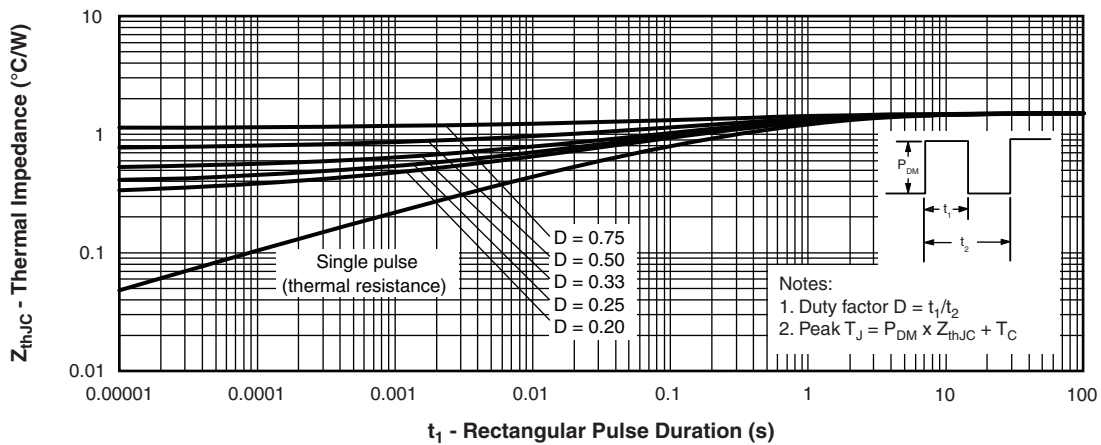

Fig. 4 - Maximum Thermal Impedance Z_{thJC} Characteristics

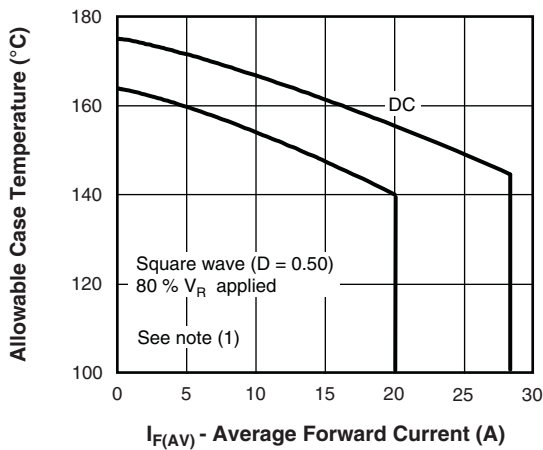

Fig. 5 - Maximum Allowable Case Temperature vs. Average Forward Current

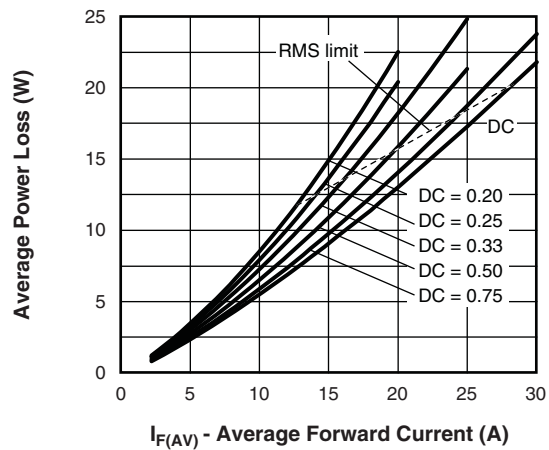

Fig. 6 - Forward Power Loss Characteristics

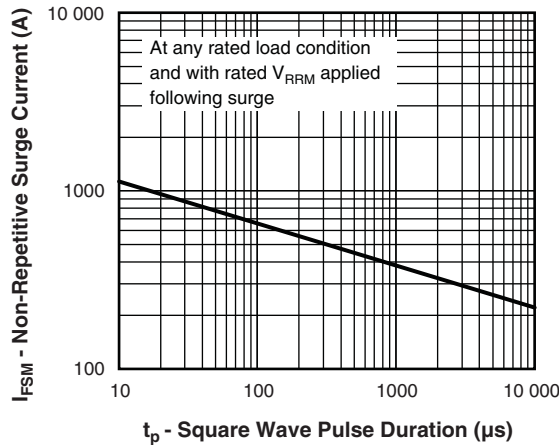

Fig. 7 - Maximum Non-Repetitive Surge Current (Per Leg)

Note

- (1) Formula used: $T_C = T_J - (P_d + P_{d_{REV}}) \times R_{thJC}$;
- P_d = forward power loss = $I_{F(AV)} \times V_{FM}$ at $(I_{F(AV)}/D)$ (see fig. 6);
- $P_{d_{REV}}$ = inverse power loss = $V_{R1} \times I_R (1 - D)$; I_R at $V_{R1} = 80\% V_R$ applied



ORDERING INFORMATION TABLE

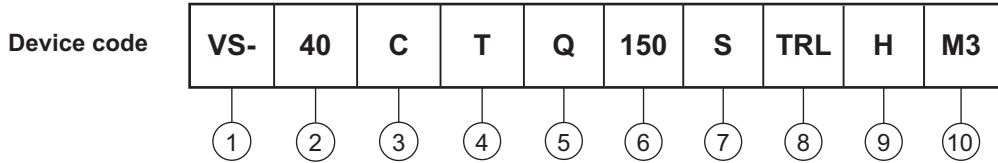

- 1** - Vishay Semiconductors product
- 2** - Current rating (40 A)
- 3** - Circuit configuration:
C = common cathode
- 4** - T = TO-220
- 5** - Schottky "Q" series
- 6** - Voltage rating (150 = 150 V)
- 7** - • S = D²PAK
• -1 = TO-262
- 8** - • None = tube (50 pieces)
• TRL = tape and reel (left oriented - for D²PAK only)
• TRR = tape and reel (right oriented - for D²PAK only)
- 9** - H = AEC-Q101 qualified
- 10** - M3 = halogen-free, RoHS-compliant, and termination lead (Pb)-free

ORDERING INFORMATION (Example)			
PREFERRED P/N	QUANTITY PER T/R	MINIMUM ORDER QUANTITY	PACKAGING DESCRIPTION
VS-40CTQ150SHM3	50	1000	Antistatic plastic tubes
VS-40CTQ150STRLHM3	800	800	13" diameter reel
VS-40CTQ150STRRHM3	800	800	13" diameter reel
VS-40CTQ150-1HM3	50	1000	Antistatic plastic tubes

LINKS TO RELATED DOCUMENTS		
Dimensions	D ² PAK (TO-263AB)	www.vishay.com/doc?96164
	TO-262AA	www.vishay.com/doc?96165
Part marking information	D ² PAK (TO-263AB)	www.vishay.com/doc?95444
	TO-262AA	www.vishay.com/doc?95443
Packaging information		www.vishay.com/doc?95032
SPICE model		www.vishay.com/doc?95434

TO-262AA

DIMENSIONS in millimeters and inches

Modified JEDEC® outline TO-262

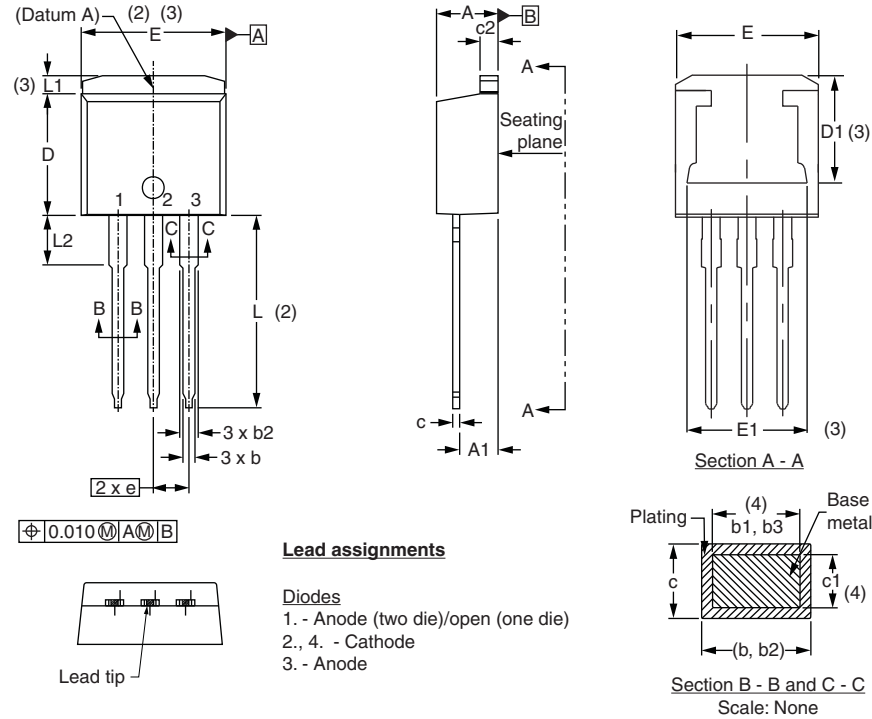

SYMBOL	MILLIMETERS		INCHES		NOTES
	MIN.	MAX.	MIN.	MAX.	
A	4.06	4.83	0.160	0.190	
A1	2.03	3.02	0.080	0.119	
b	0.51	0.99	0.020	0.039	
b1	0.51	0.89	0.020	0.035	4
b2	1.14	1.78	0.045	0.070	
b3	1.14	1.73	0.045	0.068	4
c	0.38	0.74	0.015	0.029	
c1	0.38	0.58	0.015	0.023	4
c2	1.14	1.65	0.045	0.065	
D	8.51	9.65	0.335	0.380	2
D1	6.86	8.00	0.270	0.315	3
E	9.65	10.67	0.380	0.420	2, 3
E1	7.90	8.80	0.311	0.346	3
e	2.54 BSC		0.100 BSC		
L	13.46	14.10	0.530	0.555	
L1	-	1.65	-	0.065	3
L2	3.56	3.71	0.140	0.146	

Notes

- (1) Dimensioning and tolerancing as per ASME Y14.5M-1994
- (2) Dimension D and E do not include mold flash. Mold flash shall not exceed 0.127 mm (0.005") per side. These dimensions are measured at the outmost extremes of the plastic body
- (3) Thermal pad contour optional within dimension E, L1, D1 and E1
- (4) Dimension b1 and c1 apply to base metal only
- (5) Controlling dimension: inches
- (6) Outline conform to JEDEC® TO-262 except A1 (max.), b (min., max.), b1 (min.), b2 (max.), c (min.), c1(min.), c2 (max.), D (min.), E (max.), L1 (max.), L2 (min., max.)



Disclaimer

ALL PRODUCT, PRODUCT SPECIFICATIONS AND DATA ARE SUBJECT TO CHANGE WITHOUT NOTICE TO IMPROVE RELIABILITY, FUNCTION OR DESIGN OR OTHERWISE.

Vishay Intertechnology, Inc., its affiliates, agents, and employees, and all persons acting on its or their behalf (collectively, "Vishay"), disclaim any and all liability for any errors, inaccuracies or incompleteness contained in any datasheet or in any other disclosure relating to any product.

Vishay makes no warranty, representation or guarantee regarding the suitability of the products for any particular purpose or the continuing production of any product. To the maximum extent permitted by applicable law, Vishay disclaims (i) any and all liability arising out of the application or use of any product, (ii) any and all liability, including without limitation special, consequential or incidental damages, and (iii) any and all implied warranties, including warranties of fitness for particular purpose, non-infringement and merchantability.

Statements regarding the suitability of products for certain types of applications are based on Vishay's knowledge of typical requirements that are often placed on Vishay products in generic applications. Such statements are not binding statements about the suitability of products for a particular application. It is the customer's responsibility to validate that a particular product with the properties described in the product specification is suitable for use in a particular application. Parameters provided in datasheets and / or specifications may vary in different applications and performance may vary over time. All operating parameters, including typical parameters, must be validated for each customer application by the customer's technical experts. Product specifications do not expand or otherwise modify Vishay's terms and conditions of purchase, including but not limited to the warranty expressed therein.

Hyperlinks included in this datasheet may direct users to third-party websites. These links are provided as a convenience and for informational purposes only. Inclusion of these hyperlinks does not constitute an endorsement or an approval by Vishay of any of the products, services or opinions of the corporation, organization or individual associated with the third-party website. Vishay disclaims any and all liability and bears no responsibility for the accuracy, legality or content of the third-party website or for that of subsequent links.

Except as expressly indicated in writing, Vishay products are not designed for use in medical, life-saving, or life-sustaining applications or for any other application in which the failure of the Vishay product could result in personal injury or death. Customers using or selling Vishay products not expressly indicated for use in such applications do so at their own risk. Please contact authorized Vishay personnel to obtain written terms and conditions regarding products designed for such applications.

No license, express or implied, by estoppel or otherwise, to any intellectual property rights is granted by this document or by any conduct of Vishay. Product names and markings noted herein may be trademarks of their respective owners.