

## DATASHEET

# UF3C065030B3

## 650V-27mΩ SiC FET

Rev. C, May 2023

### Description

This SiC FET device is based on a unique ‘cascode’ circuit configuration, in which a normally-on SiC JFET is co-packaged with a Si MOSFET to produce a normally-off SiC FET device. The device’s standard gate-drive characteristics allows for a true “drop-in replacement” to Si IGBTs, Si FETs, SiC MOSFETs or Si superjunction devices. Available in the D<sup>2</sup>PAK-3L package, this device exhibits ultra-low gate charge and exceptional reverse recovery characteristics, making it ideal for switching inductive loads when used with recommended RC-snubbers, and any application requiring standard gate drive.

### Features

- ◆ Typical on-resistance  $R_{DS(on),typ}$  of 27mΩ
- ◆ Maximum operating temperature of 175°C
- ◆ Excellent reverse recovery
- ◆ Low gate charge
- ◆ Low intrinsic capacitance
- ◆ ESD protected, HBM class 2
- ◆ Very low switching losses (required RC-snubber loss negligible under typical operating conditions)

### Typical applications

- ◆ EV charging
- ◆ PV inverters
- ◆ Switch mode power supplies
- ◆ Power factor correction modules
- ◆ Motor drives
- ◆ Induction heating

TAB

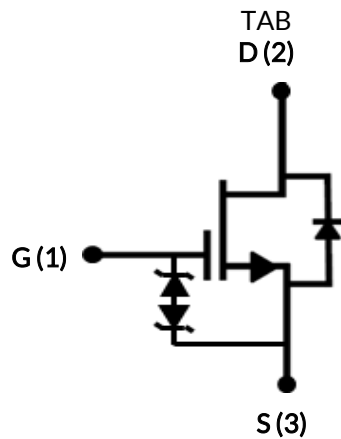
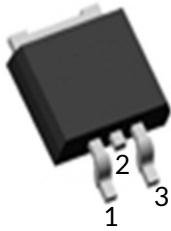

Part Number	Package	Marking
UF3C065030B3	D <sup>2</sup> PAK-3L	UF3C065030B3



## Maximum Ratings

Parameter	Symbol	Test Conditions	Value	Units
Drain-source voltage	$V_{DS}$		650	V
Gate-source voltage	$V_{GS}$	DC	-25 to +25	V
Continuous drain current <sup>1</sup>	$I_D$	$T_C = 25^\circ\text{C}$	65	A
		$T_C = 100^\circ\text{C}$	47	A
Pulsed drain current <sup>2</sup>	$I_{DM}$	$T_C = 25^\circ\text{C}$	230	A
Single pulsed avalanche energy <sup>3</sup>	$E_{AS}$	$L=15\text{mH}, I_{AS}=4\text{A}$	120	mJ
Power dissipation	$P_{tot}$	$T_C = 25^\circ\text{C}$	242	W
Maximum junction temperature	$T_{J,max}$		175	$^\circ\text{C}$
Operating and storage temperature	$T_J, T_{STG}$		-55 to 175	$^\circ\text{C}$
Reflow soldering temperature	$T_{solder}$	reflow MSL 1	245	$^\circ\text{C}$

1. Limited by  $T_{J,max}$

2. Pulse width  $t_p$  limited by  $T_{J,max}$

3. Starting  $T_J = 25^\circ\text{C}$

## Thermal Characteristics

Parameter	Symbol	Test Conditions	Value			Units
			Min	Typ	Max	
Thermal resistance, junction-to-case	$R_{\theta JC}$			0.48	0.62	$^\circ\text{C}/\text{W}$

## Electrical Characteristics ( $T_J = +25^\circ\text{C}$ unless otherwise specified)

### Typical Performance - Static

Parameter	Symbol	Test Conditions	Value			Units
			Min	Typ	Max	
Drain-source breakdown voltage	$BV_{DS}$	$V_{GS}=0V, I_D=1mA$	650			V
Total drain leakage current	$I_{DSS}$	$V_{DS}=650V, V_{GS}=0V, T_J=25^\circ\text{C}$		6	150	$\mu\text{A}$
		$V_{DS}=650V, V_{GS}=0V, T_J=175^\circ\text{C}$		30		
Total gate leakage current	$I_{GSS}$	$V_{DS}=0V, T_J=25^\circ\text{C}, V_{GS}=-20V / +20V$		6	$\pm 20$	$\mu\text{A}$
Drain-source on-resistance	$R_{DS(on)}$	$V_{GS}=12V, I_D=40A, T_J=25^\circ\text{C}$		27	35	m $\Omega$
		$V_{GS}=12V, I_D=40A, T_J=125^\circ\text{C}$		35		
		$V_{GS}=12V, I_D=40A, T_J=175^\circ\text{C}$		43		
Gate threshold voltage	$V_{G(th)}$	$V_{DS}=5V, I_D=10mA$	4	5	6	V
Gate resistance	$R_G$	f=1MHz, open drain		4.5		$\Omega$

### Typical Performance - Reverse Diode

Parameter	Symbol	Test Conditions	Value			Units
			Min	Typ	Max	
Diode continuous forward current <sup>1</sup>	$I_S$	$T_C=25^\circ\text{C}$			65	A
Diode pulse current <sup>2</sup>	$I_{S,pulse}$	$T_C=25^\circ\text{C}$			230	A
Forward voltage	$V_{FSD}$	$V_{GS}=0V, I_S=20A, T_J=25^\circ\text{C}$		1.3	1.4	V
		$V_{GS}=0V, I_S=20A, T_J=175^\circ\text{C}$		1.35		
Reverse recovery charge	$Q_{rr}$	$V_R=400V, I_S=40A, V_{GS}=-5V, R_{G,EXT}=22\Omega, di/dt=1500A/\mu\text{s}, T_J=25^\circ\text{C}$		211		nC
Reverse recovery time	$t_{rr}$	$T_J=25^\circ\text{C}$		34		ns
Reverse recovery charge	$Q_{rr}$	$V_R=400V, I_S=40A, V_{GS}=-5V, R_{G,EXT}=22\Omega, di/dt=1500A/\mu\text{s}, T_J=150^\circ\text{C}$		188		nC
Reverse recovery time	$t_{rr}$	$T_J=150^\circ\text{C}$		32		ns

## Typical Performance - Dynamic

Parameter	Symbol	Test Conditions	Value			Units		
			Min	Typ	Max			
Input capacitance	$C_{iss}$	$V_{DS}=100V, V_{GS}=0V$ $f=100kHz$		1500		pF		
Output capacitance	$C_{oss}$			293				
Reverse transfer capacitance	$C_{rss}$			2				
Effective output capacitance, energy related	$C_{oss(er)}$	$V_{DS}=0V$ to 400V, $V_{GS}=0V$		215		pF		
Effective output capacitance, time related	$C_{oss(tr)}$	$V_{DS}=0V$ to 400V, $V_{GS}=0V$		480		pF		
$C_{oss}$ stored energy	$E_{oss}$	$V_{DS}=400V, V_{GS}=0V$		17.5		$\mu J$		
Total gate charge	$Q_G$	$V_{DS}=400V, I_D=40A,$ $V_{GS} = -5V$ to 15V		51		nC		
Gate-drain charge	$Q_{GD}$			11				
Gate-source charge	$Q_{GS}$			19				
Turn-on delay time	$t_{d(on)}$	$V_{DS}=400V, I_D=40A,$ Gate Driver = -5V to +15V, Turn-on $R_{G,EXT}=1.8\Omega,$ Turn-off $R_{G,EXT}=22\Omega$ Inductive Load,		34		ns		
Rise time	$t_r$			16				
Turn-off delay time	$t_{d(off)}$			56				
Fall time	$t_f$			15				
Turn-on energy including $R_S$ energy <sup>4</sup>	$E_{ON}$			392				
Turn-off energy including $R_S$ energy <sup>4</sup>	$E_{OFF}$			113				
Total switching energy including $R_S$ energy <sup>4</sup>	$E_{TOTAL}$	FWD: same device with $V_{GS} = -5V$ and $R_G = 22\Omega,$ RC snubber: $R_S=5\Omega$ and $C_S=330pF, T_J=25^\circ C$		505		$\mu J$		
Snubber $R_S$ energy during turn-on	$E_{RS\_ON}$			5.3				
Snubber $R_S$ energy during turn-off	$E_{RS\_OFF}$			7.9				
Turn-on delay time	$t_{d(on)}$			32				
Rise time	$t_r$			16				
Turn-off delay time	$t_{d(off)}$	$V_{DS}=400V, I_D=40A,$ Gate Driver = -5V to +15V, Turn-on $R_{G,EXT}=1.8\Omega,$ Turn-off $R_{G,EXT}=22\Omega$ Inductive Load,		57		ns		
Fall time	$t_f$			16				
Turn-on energy including $R_S$ energy <sup>4</sup>	$E_{ON}$			370				
Turn-off energy including $R_S$ energy <sup>4</sup>	$E_{OFF}$			118				
Total switching energy including $R_S$ energy <sup>4</sup>	$E_{TOTAL}$		FWD: same device with $V_{GS} = -5V$ and $R_G = 22\Omega,$ RC snubber: $R_S=5\Omega$ and $C_S=330pF, T_J=150^\circ C$		488			$\mu J$
Snubber $R_S$ energy during turn-on	$E_{RS\_ON}$				4.6			
Snubber $R_S$ energy during turn-off	$E_{RS\_OFF}$			8.2				

4. The switching performance are evaluated with a RC snubber circuit as shown in Figure 24.

Typical Performance Diagrams

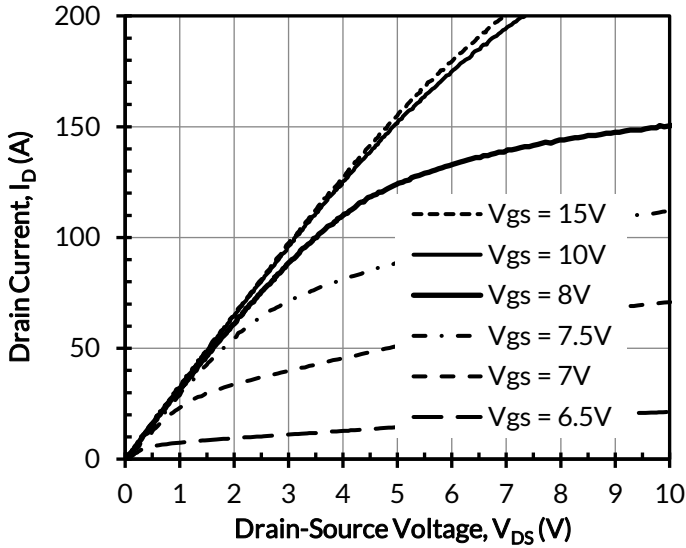

Figure 1. Typical output characteristics at  $T_J = -55^\circ\text{C}$ ,  $t_p < 250\mu\text{s}$

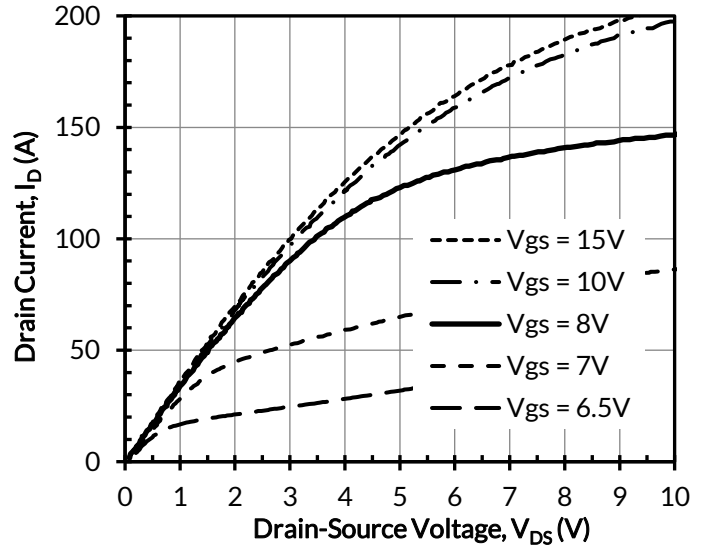

Figure 2. Typical output characteristics at  $T_J = 25^\circ\text{C}$ ,  $t_p < 250\mu\text{s}$

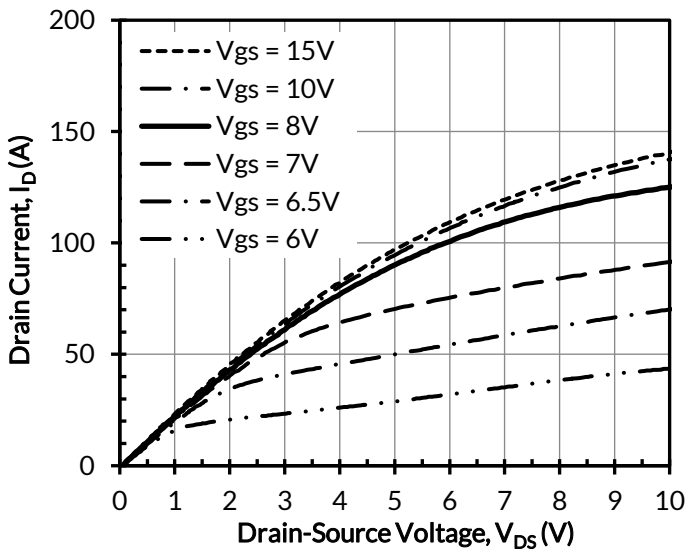

Figure 3. Typical output characteristics at  $T_J = 175^\circ\text{C}$ ,  $t_p < 250\mu\text{s}$

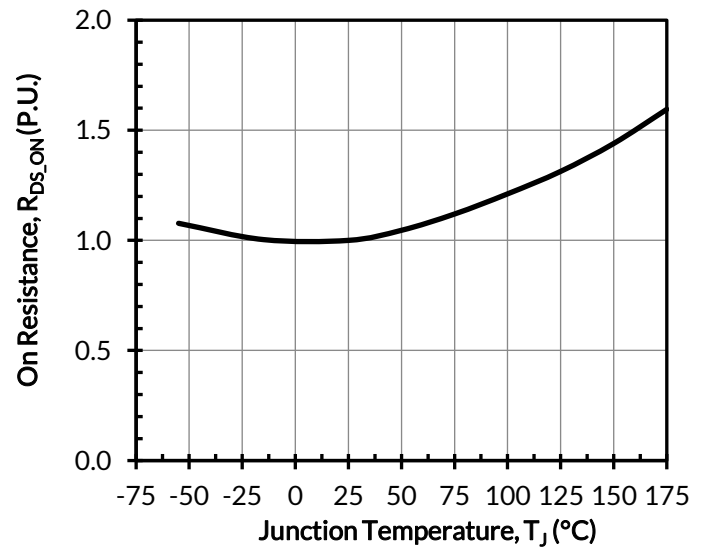

Figure 4. Normalized on-resistance vs. temperature at  $V_{GS} = 12\text{V}$  and  $I_D = 40\text{A}$

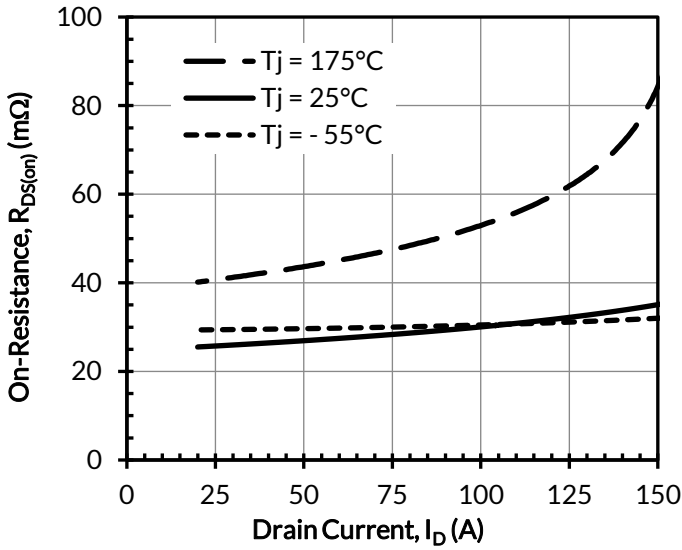

Figure 5. Typical drain-source on-resistances at  $V_{GS} = 12\text{V}$

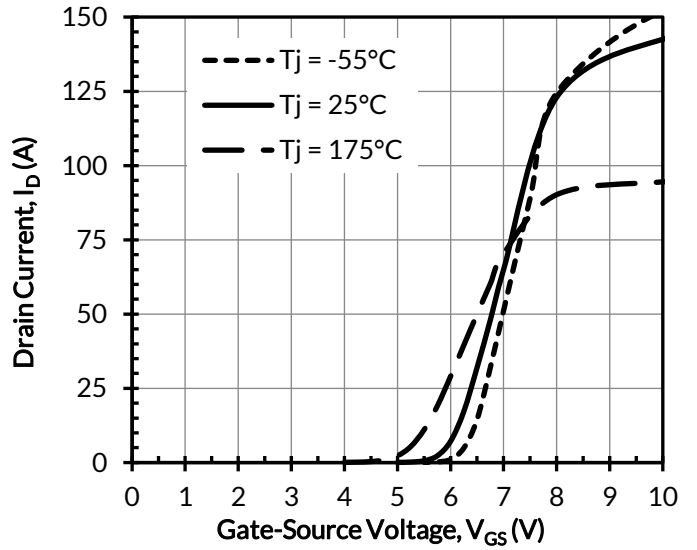

Figure 6. Typical transfer characteristics at  $V_{DS} = 5\text{V}$

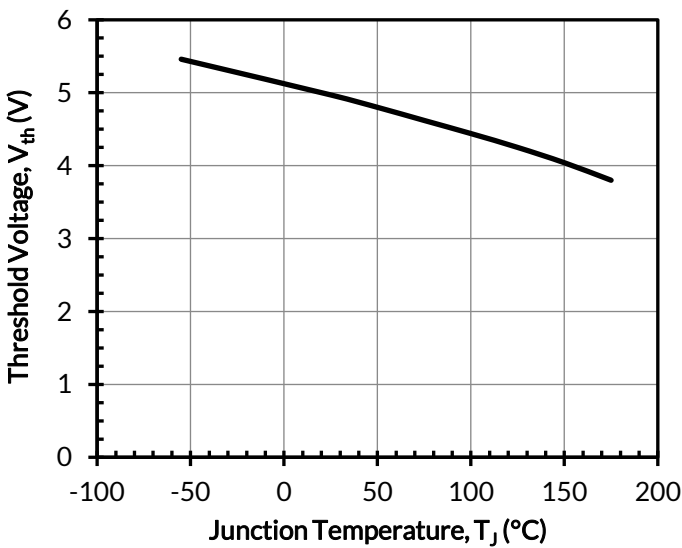

Figure 7. Threshold voltage vs. junction temperature at  $V_{DS} = 5\text{V}$  and  $I_D = 10\text{mA}$

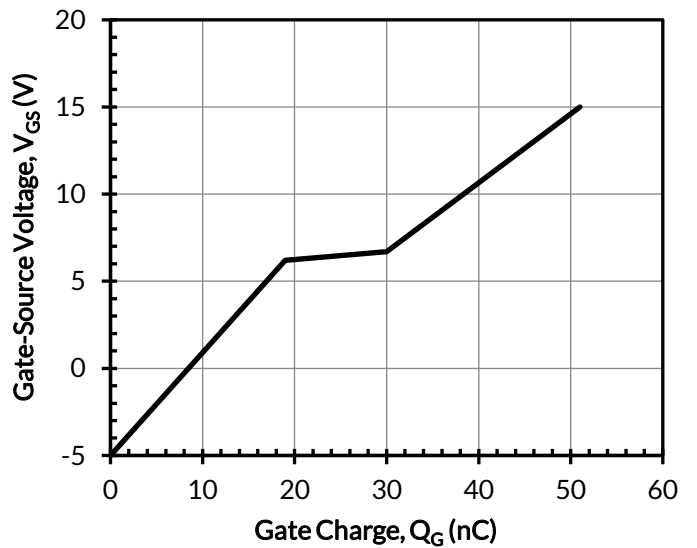

Figure 8. Typical gate charge at  $V_{DS} = 400\text{V}$  and  $I_D = 40\text{A}$

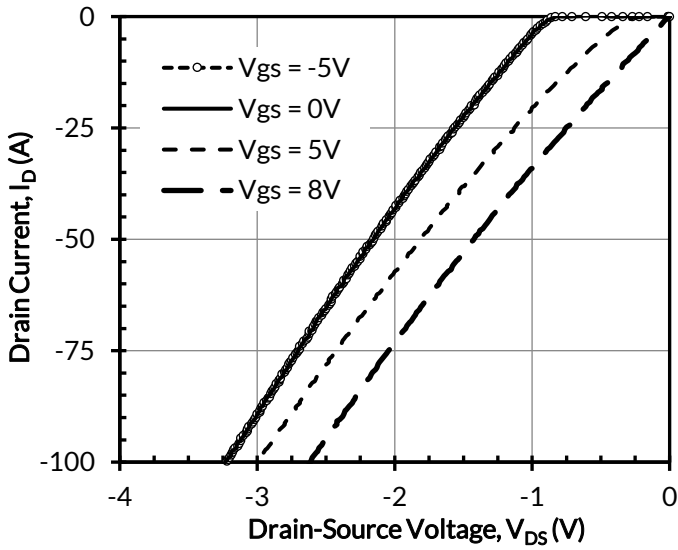

Figure 9. 3rd quadrant characteristics at  $T_j = -55^\circ\text{C}$

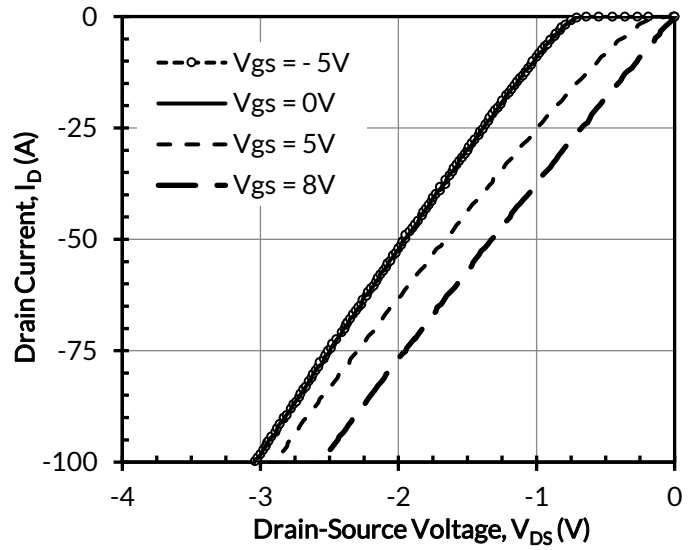

Figure 10. 3rd quadrant characteristics at  $T_j = 25^\circ\text{C}$

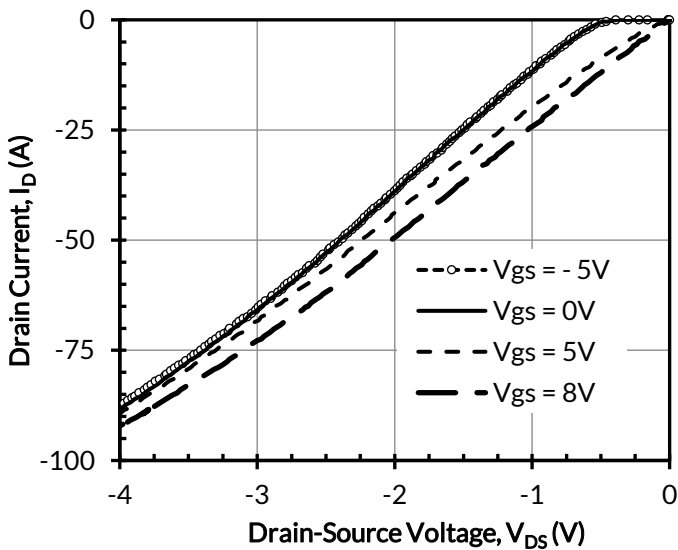

Figure 11. 3rd quadrant characteristics at  $T_j = 175^\circ\text{C}$

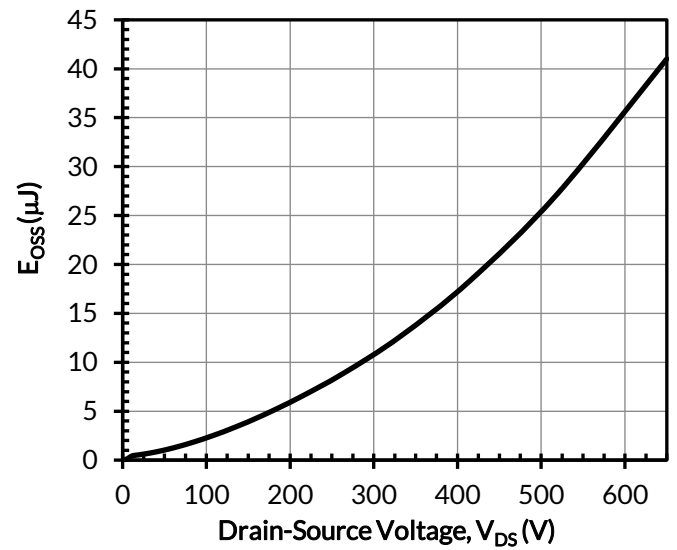

Figure 12. Typical stored energy in  $C_{OSS}$  at  $V_{GS} = 0\text{V}$

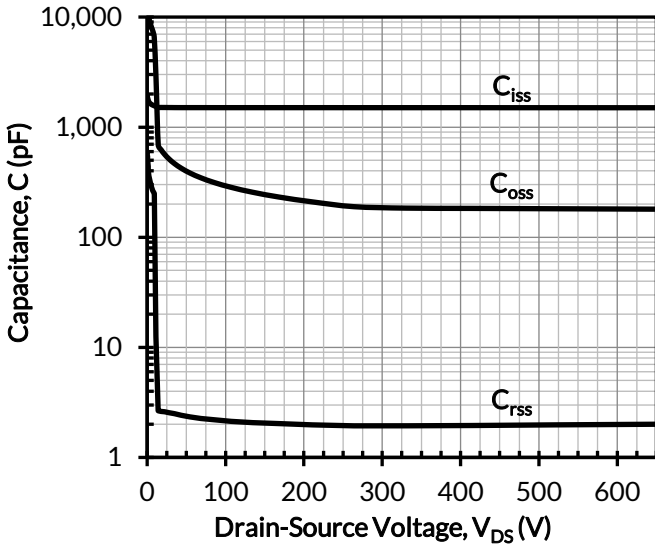

Figure 13. Typical capacitances at  $f = 100\text{kHz}$  and  $V_{GS} = 0\text{V}$

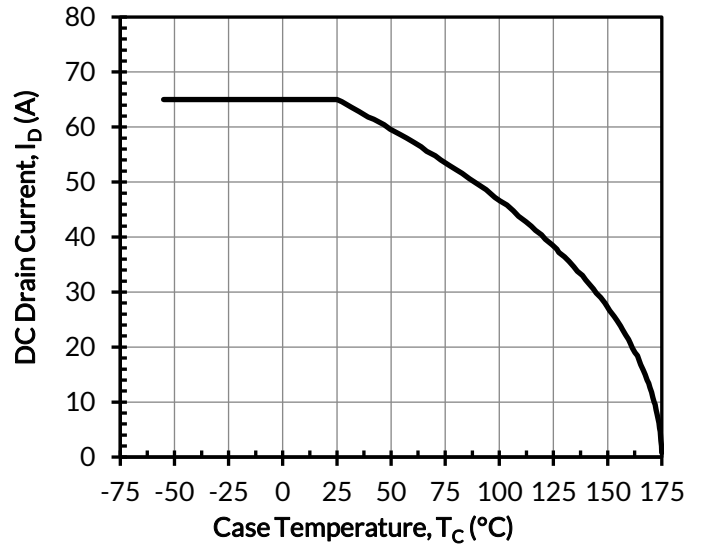

Figure 14. DC drain current derating

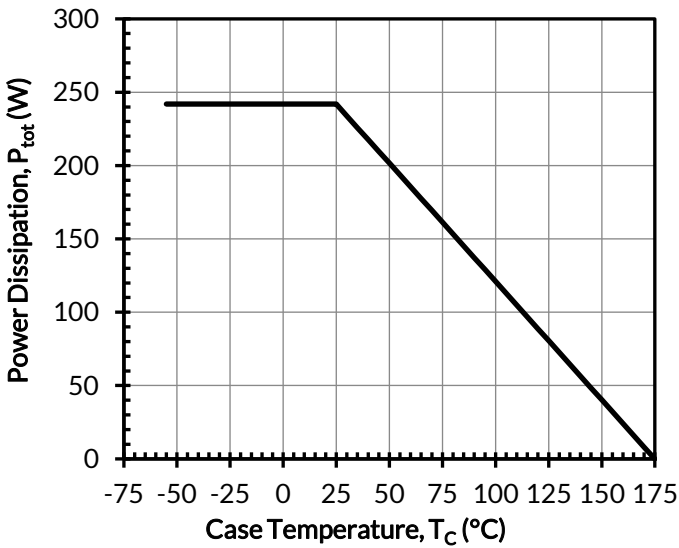

Figure 15. Total power dissipation

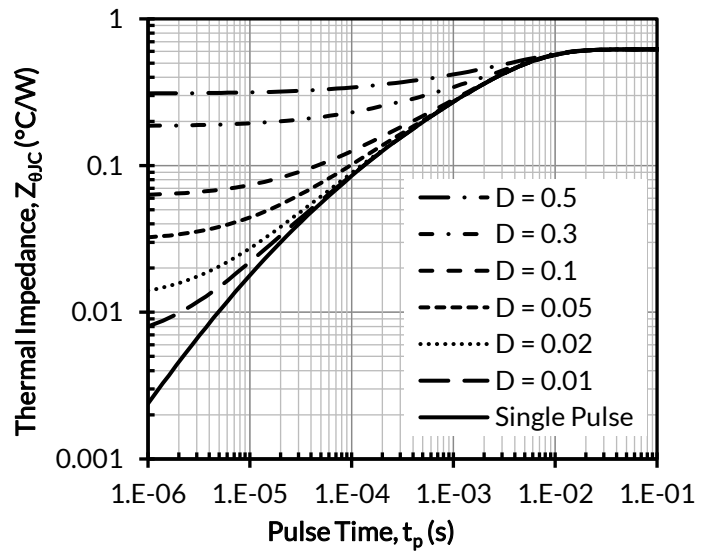

Figure 16. Maximum transient thermal impedance



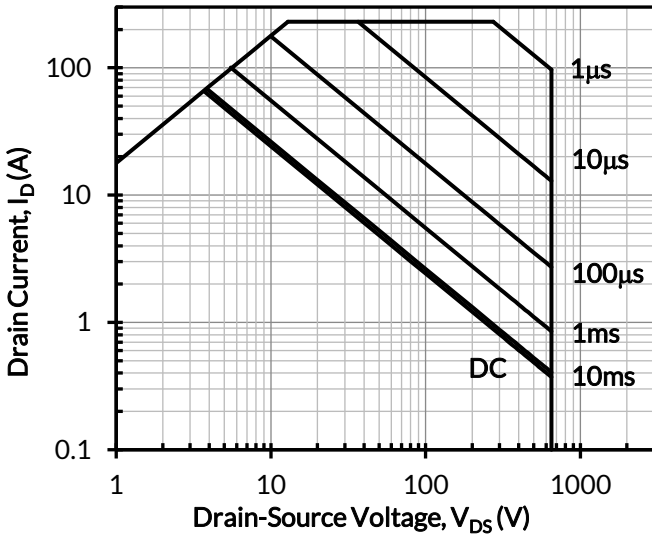

Figure 17. Safe operation area at  $T_C = 25^\circ\text{C}$ ,  $D = 0$ , Parameter  $t_p$

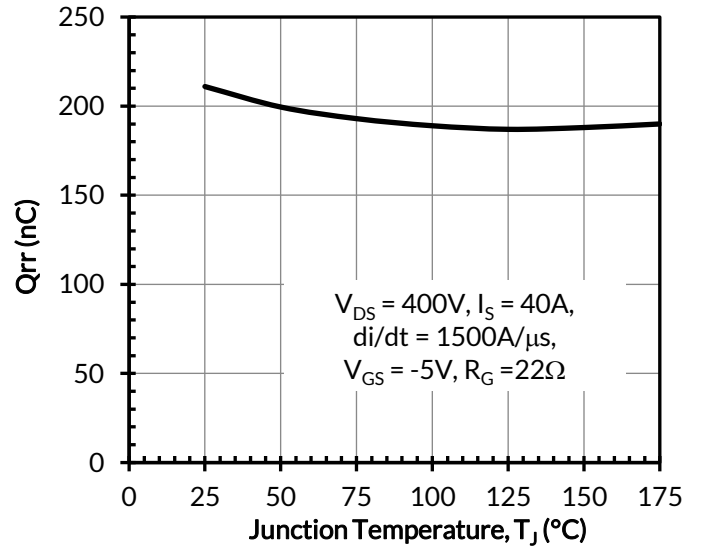
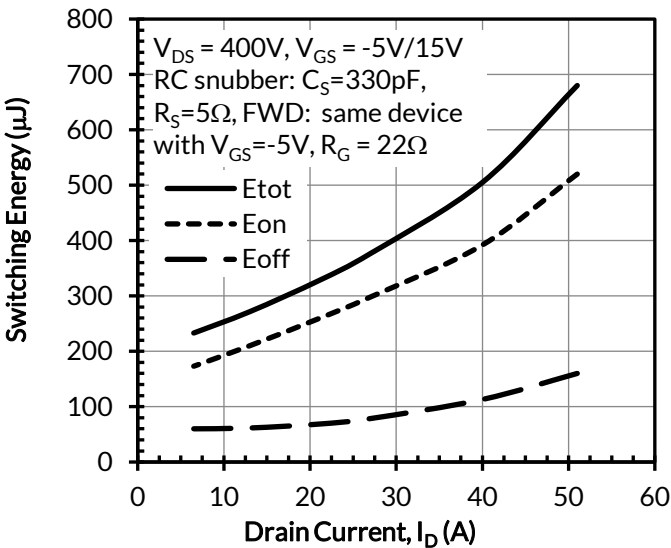
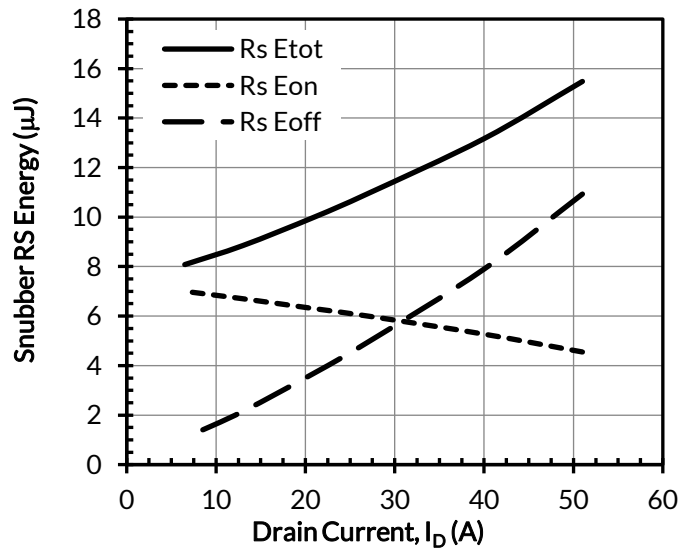

Figure 18. Reverse recovery charge  $Q_{rr}$  vs. junction temperature



(a)



(b)

Figure 19. Clamped inductive switching energy (a) and RC snubber energy loss (b) vs. drain current at  $T_J = 25^\circ\text{C}$ , turn-on  $R_{G\_EXT} = 1.8\Omega$ , and turn-off  $R_{G\_EXT} = 22\Omega$

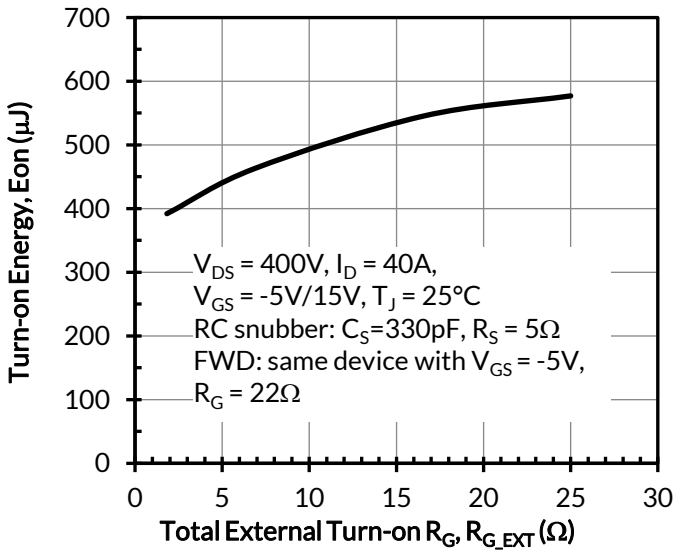

(a)

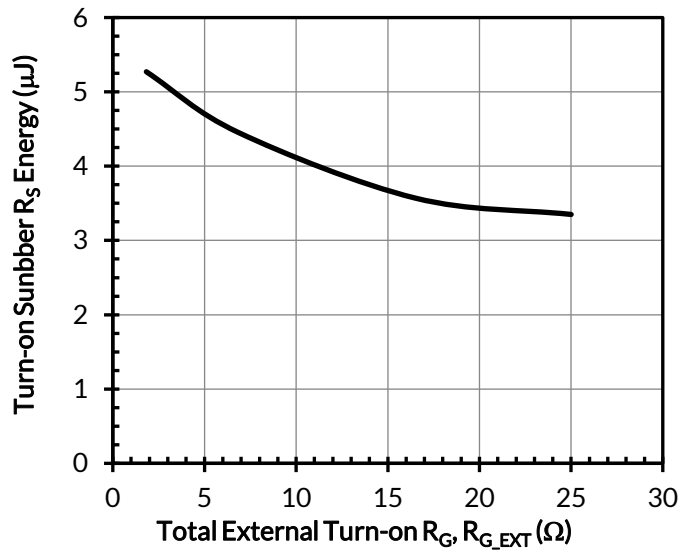

(b)

Figure 20. Clamped inductive switching turn-on energy including RC snubber energy loss (a) and RC snubber energy loss (b) as a function of total external turn-on gate resistor  $R_{G\_EXT}$

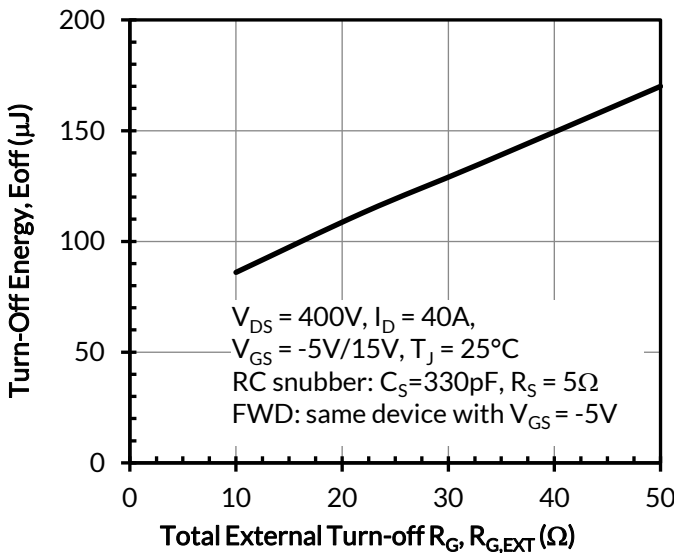

(a)

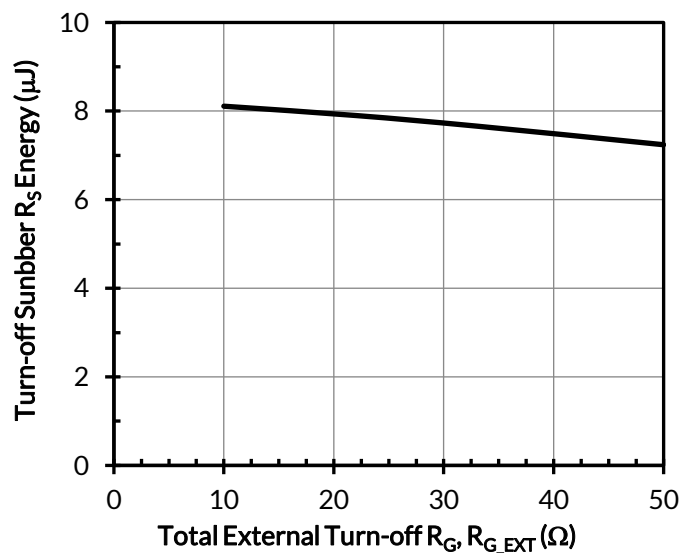

(b)

Figure 21. Clamped inductive switching turn-off energy including RC snubber energy loss (a) and RC snubber energy loss (b) as a function of total external turn-off gate resistor  $R_{G\_EXT}$

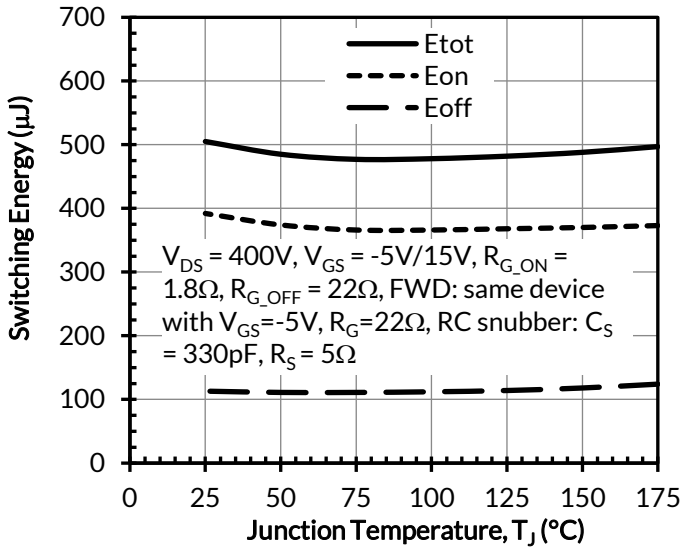

(a)

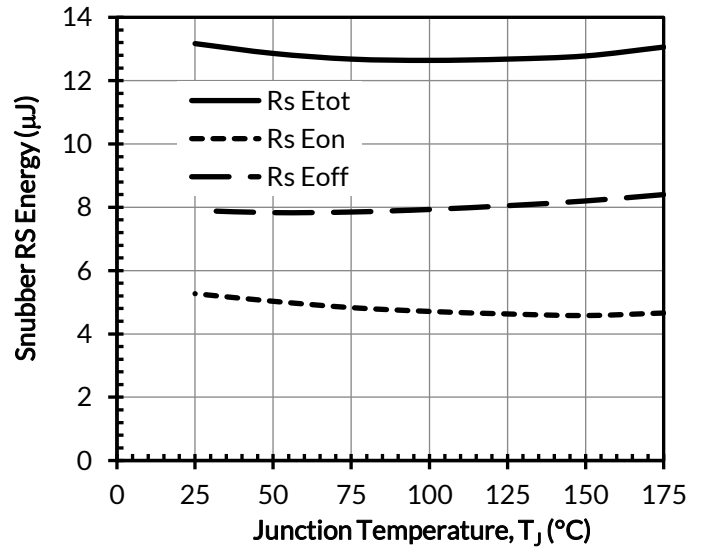

(b)

Figure 22. Clamped inductive switching energy including RC snubber energy loss (a) and RC snubber energy loss (b) as a function of junction temperature at  $I_D = 40A$

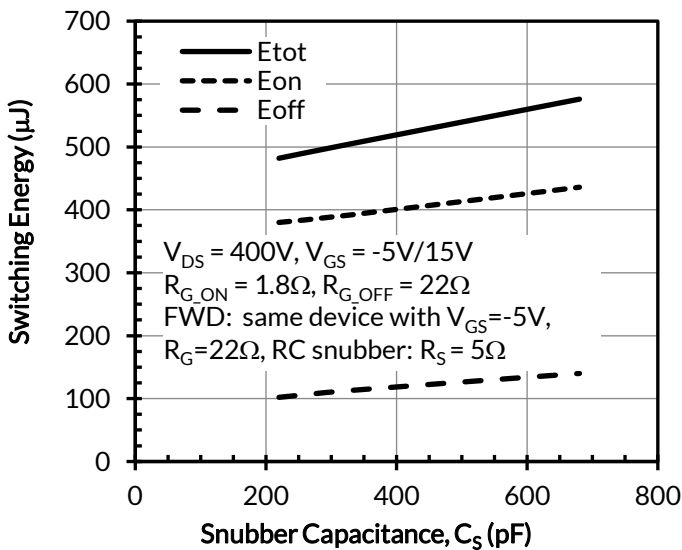

(a)

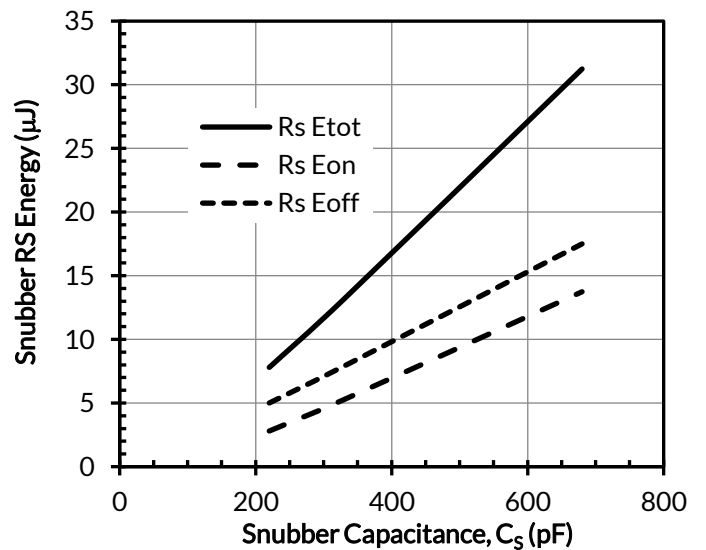

(b)

Figure 23. Clamped inductive switching energy including RC snubber energy loss (a) and RC snubber energy loss (b) as a function of snubber capacitance at  $I_D = 40A$  and  $T_J = 25^\circ C$

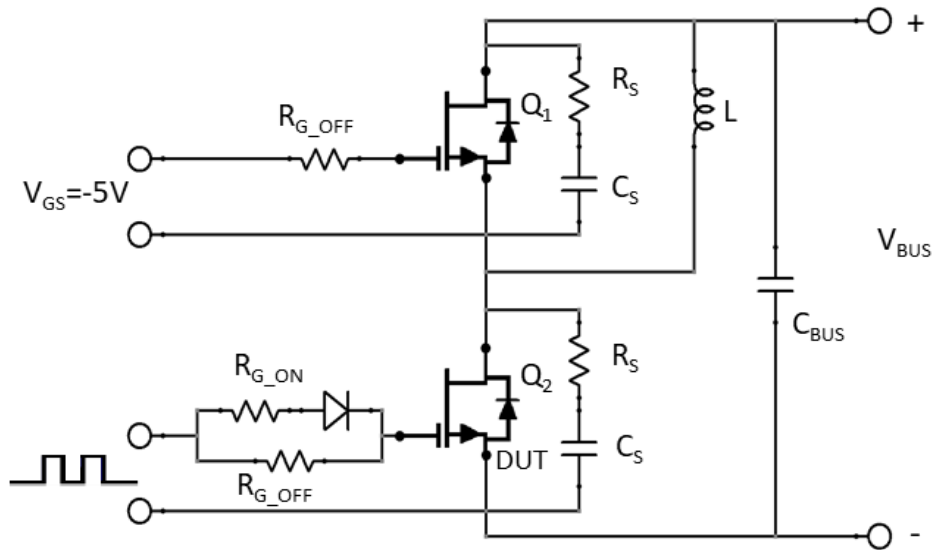

Figure 24. Clamped inductive load switching test circuit  
 An RC snubber ( $R_S = 5\Omega$  and  $C_S = 330\text{pF}$ ) is required to improve the turn-off waveforms.

## Applications Information

SiC FETs are enhancement-mode power switches formed by a high-voltage SiC depletion-mode JFET and a low-voltage silicon MOSFET connected in series. The silicon MOSFET serves as the control unit while the SiC JFET provides high voltage blocking in the off state. This combination of devices in a single package provides compatibility with standard gate drivers and offers superior performance in terms of low on-resistance ( $R_{DS(on)}$ ), output capacitance ( $C_{oss}$ ), gate charge ( $Q_G$ ), and reverse recovery charge ( $Q_{rr}$ ) leading to low conduction and switching losses. The SiC FETs also provide excellent reverse conduction capability eliminating the need for an external anti-parallel diode.

Like other high performance power switches, proper PCB layout design to minimize circuit parasitics is strongly recommended due to the high  $dv/dt$  and  $di/dt$  rates. An external gate resistor is recommended when the FET is working in the diode mode in order to achieve the optimum reverse recovery performance. For more information on SiC FET operation, see [www.unitedsic.com](http://www.unitedsic.com).

A snubber circuit with a small  $R_{(G)}$ , or gate resistor, provides better EMI suppression with higher efficiency compared to using a high  $R_{(G)}$  value. There is no extra gate delay time when using the snubber circuitry, and a small  $R_{(G)}$  will better control both the turn-off  $V_{(DS)}$  peak spike and ringing duration, while a high  $R_{(G)}$  will damp the peak spike but result in a longer delay time. In addition, the total switching loss when using a snubber circuit is less than using high  $R_{(G)}$ , while greatly reducing  $E_{(OFF)}$  from mid-to-full load range with only a small increase in  $E_{(ON)}$ . Efficiency will therefore improve with higher load current. For more information on how a snubber circuit will improve overall system performance, visit the UnitedSiC website at [www.unitedsic.com](http://www.unitedsic.com)

## Important notice

The information contained herein is believed to be reliable; however, Qorvo makes no warranties regarding the information contained herein and assumes no responsibility or liability whatsoever for the use of the information contained herein. All information contained herein is subject to change without notice. Customers should obtain and verify the latest relevant information before placing orders for Qorvo products. The information contained herein or any use of such information does not grant, explicitly or implicitly, to any party any patent rights, licenses, or any other intellectual property rights, whether with regard to such information itself or anything described by such information. THIS INFORMATION DOES NOT CONSTITUTE A WARRANTY WITH RESPECT TO THE PRODUCTS DESCRIBED HEREIN, AND QORVO HEREBY DISCLAIMS ANY AND ALL WARRANTIES WITH RESPECT TO SUCH PRODUCTS WHETHER EXPRESS OR IMPLIED BY LAW, COURSE OF DEALING, COURSE OF PERFORMANCE, USAGE OF TRADE OR OTHERWISE, INCLUDING THE IMPLIED WARRANTIES OF MERCHANTABILITY AND FITNESS FOR A PARTICULAR PURPOSE. Without limiting the generality of the foregoing, Qorvo products are not warranted or authorized for use as critical components in medical, life-saving, or life-sustaining applications, or other applications where a failure would reasonably be expected to cause severe personal injury or death.