

HS6B Subminiature Interlock Switches

World-class compactness with three poles of contacts.

- World's smallest switch: 30 × 15 × 78 mm
- Dual contacts and monitor contacts achieve the highest safety category (ISO 13849-1, EN 954-1)
- Two actuator entry slots provide flexibility for installation options.
- Integral cable design minimizes wiring, preventing wiring mistakes.
- Can be mounted in two directions.
- Degree of protection (contacts): IP67 (IEC 60529)
Housing allows drainage.
- NC contacts are direct opening action (IEC/EN 60947-5-1).
- Proprietary actuators prevent unauthorized opening of the contacts (ISO14119, EN1088).

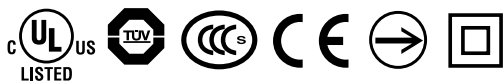

Interlock Switch

Contact Configuration	Cable Length	Part No. (Package quantity: 1)
	1m	HS6B-11B01
	3m	HS6B-11B03
	5m	HS6B-11B05
	1m	HS6B-02B01
	3m	HS6B-02B03
	5m	HS6B-02B05
	1m	HS6B-12B01
	3m	HS6B-12B03
	5m	HS6B-12B05
	1m	HS6B-03B01
	3m	HS6B-03B03
	5m	HS6B-03B05

- Contact configuration shows the status when the actuator is inserted.

Actuators

Description	Part No. (Package quantity: 1)
Straight Actuator	HS9Z-A61
Right-angle Actuator	HS9Z-A62
Horizontal/vertical Angle Adjustable Actuator (for hinged doors) (Note)	HS9Z-A65
	HS9Z-A66

Note: Select an actuator that moves in the direction required by the hinged door and interlock switch (see pages 9 and 10).

Contact Ratings

Rated Insulation Voltage (Ui)	300V				
Rated Current (Ith)	2.5A				
Rated Voltage (Ue) *	30V	125V	250V		
Rated Current (Ie) *	AC	Resistive load (AC-12)	—	2.5A	1.5A
		Inductive Load (AC-15)	—	1.5A	0.75A
	DC	Resistive load (DC-12)	2.5A	1.1A	0.55A
		Inductive Load (DC-13)	2.3A	0.55A	0.27A

- Minimum applicable load (reference): 3V AC/DC, 5mA

Approved ratings

TÜV	AC-15 240V/0.75A DC-13 250V/0.27A DC-13 30V/2.3A
UL/c-UL	240V AC/0.75A Pilot Duty 250V DC/0.27A Pilot Duty C300 Q300
CCC	AC-15 240V/0.75A DC-13 30V/2.3A

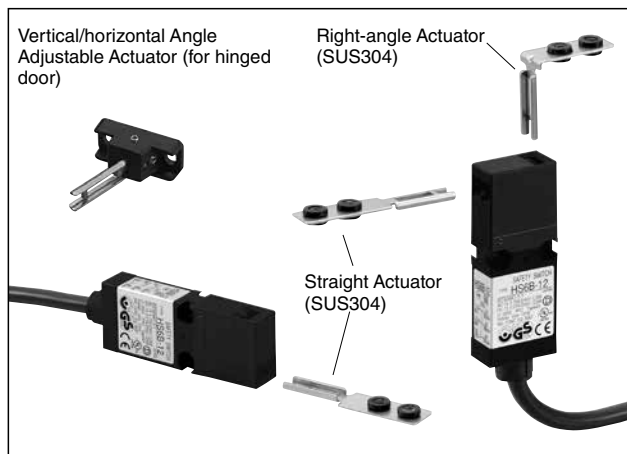

Specifications

Applicable Standards	ISO14119 EN1088 IEC60947-5-1 EN60947-5-1 (TÜV approved) GS-ET-15 (TÜV approved) UL508 (UL-listed) CSA C22.2 No. 14 (c-UL-listed) GB14048.5 (CCC approved) IEC 60204-1/ EN 60204-1 (applicable standards for use)
Applicable Directive	2006/95/EC (Low Voltage Directive) 2006/42/EC (Machinery Directive)
Operating Temperature	-25 to +70°C (no freezing)
Relative Humidity	45 to 85% (no condensation)
Storage Temperature	-40 to +80°C (no freezing)
Pollution Degree	3
Impulse Withstand Voltage	4 kV
Insulation Resistance (500V DC megger)	Between live and dead metal parts: 100 MΩ minimum Between terminals of different poles: 100 MΩ minimum
Contact Resistance	300 mΩ maximum (initial value, 1m cable) 500 mΩ maximum (initial value, 3m cable) 700 mΩ maximum (initial value, 5m cable)
Electric Shock Protection Class	Class II (IEC 61140)
Degree of Protection	IP67 (IEC 60529)
Shock Resistance	Operating extremes: 300 m/s ² (30G) Damage limits: 1000 m/s ² (100G)
Vibration Resistance	Operating extremes: 5 to 55 Hz, amplitude 0.5 mm Damage limits: 30 Hz, amplitude 1.5 mm
Actuator Operating Speed	0.05 to 1.0 m/s
Direct Opening Travel	8 mm minimum
Direct Opening Force	60N minimum
Operating Frequency	1200 operations/h
Mechanical Durability	1,000,000 operations minimum (GS-ET-15)
Electrical Durability	100,000 operations minimum (operating frequency 1200 operations/h, load AC-12 250V/1.5A, DC-12 250V/0.2A) 1,000,000 operations minimum (operating frequency 1200 operations/h, load 24V AC/DC, 100mA)
Conditional Short-circuit Current	50A (250V) (Use 250V/10A fast-blow fuse for short-circuit protection.)
Housing Color	Black
Cable	UL2464 No. 20 AWG (6-core)
Weight (approx.)	120g (HS6B-***01, cable length 1m) 270g (HS6B-***03, cable length 3m) 420g (HS6B-***05, cable length 5m)

HS6B Subminiature Interlock Switches

Dimensions

Interlock Switch

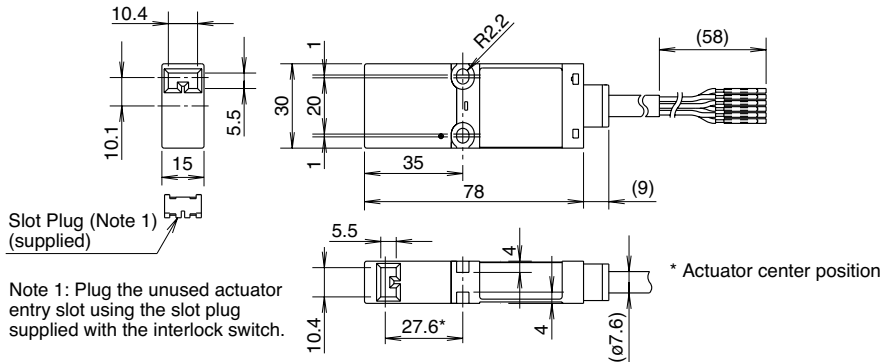

Mounting Hole Layout

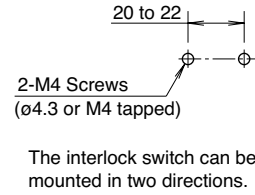

Using the HS9Z-A61 Straight Actuator

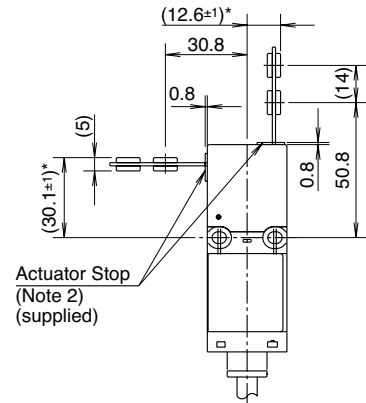

Using the HS9Z-A62 Right-angle Actuator

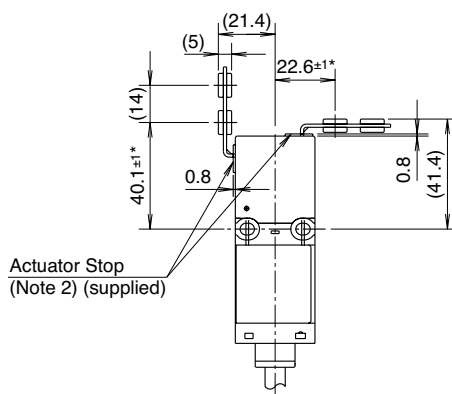

Using the HS9Z-A65/A66 Angle Adjustable Actuator

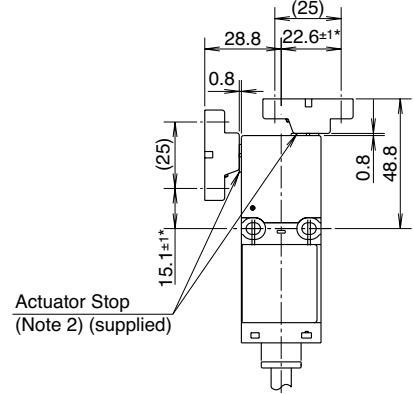

Actuator Dimensions

Straight Actuator (HS9Z-A61)

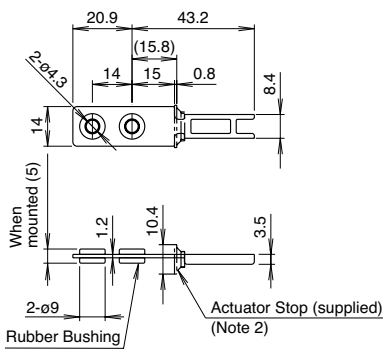

Right-angle Actuator (HS9Z-A62)

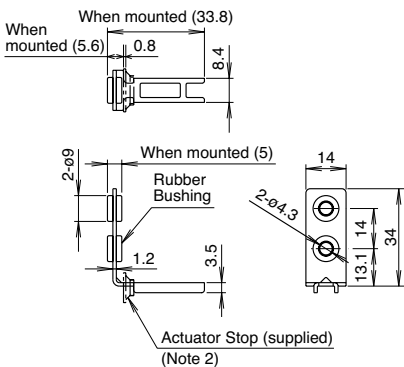

Angle Adjustable Actuator (HS9Z-A65)

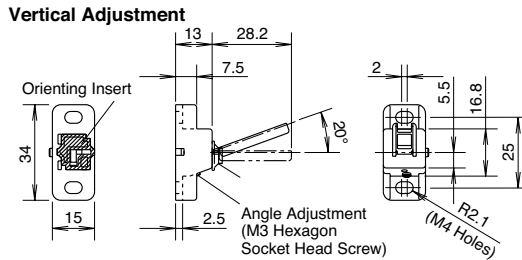
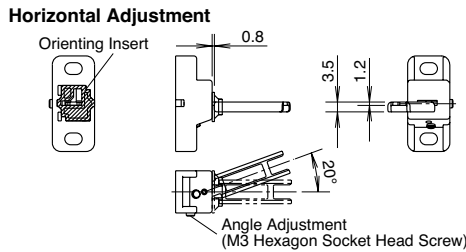

The orientation of actuator adjustment (horizontal/vertical) can be changed using the orienting insert (white plastic) installed on the back of the actuator.

The base is made of glass-reinforced PA66 (66 nylon). Angle adjustment screws are stainless steel. When using adhesive on screws, take material compatibility into consideration.

Note 2: After mounting the actuator, remove the actuator stop from the interlock switch.

Angle Adjustable Actuator (HS9Z-A66)

The HS9Z-A65 and HS9Z-A66 have the metal key inserted in opposite directions.

Horizontal Adjustment
Angle Adjustment (M3 Hexagon Socket Head Screw)

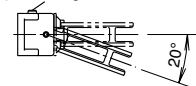

Vertical Adjustment
Angle Adjustment (M3 Hexagon Socket Head Screw)

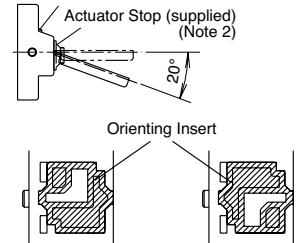

Horizontal Adjustment Vertical Adjustment

Actuator Mounting Hole Layout

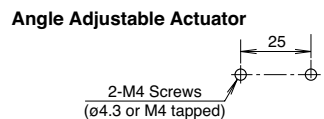
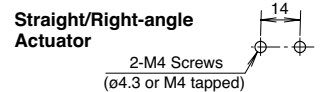

HS6B Subminiature Interlock Switches

Contact Configuration and Operation Chart

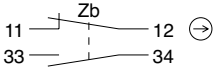
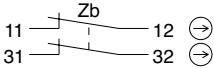
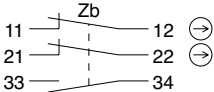
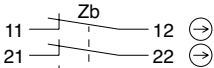
Model	Contact Configuration	Contact Operation Chart															
HS6B-11	1NC-1NO 	0.8 (Actuator Mounting Reference Position)															
		<table border="1"> <tr> <td>11-12</td> <td>0.8</td> <td>5.5</td> <td>5.8</td> <td>28.2 (Travel: mm)</td> </tr> <tr> <td>33-34</td> <td>0.8</td> <td>5.5</td> <td>5.8</td> <td>28.2 (Travel: mm)</td> </tr> </table>	11-12	0.8	5.5	5.8	28.2 (Travel: mm)	33-34	0.8	5.5	5.8	28.2 (Travel: mm)					
11-12	0.8	5.5	5.8	28.2 (Travel: mm)													
33-34	0.8	5.5	5.8	28.2 (Travel: mm)													
HS6B-02	2NC 	<table border="1"> <tr> <td>11-12</td> <td>0.8</td> <td>5.5</td> <td>5.8</td> <td>28.2 (Travel: mm)</td> </tr> <tr> <td>31-32</td> <td>0.8</td> <td>5.5</td> <td>5.8</td> <td>28.2 (Travel: mm)</td> </tr> </table>	11-12	0.8	5.5	5.8	28.2 (Travel: mm)	31-32	0.8	5.5	5.8	28.2 (Travel: mm)					
		11-12	0.8	5.5	5.8	28.2 (Travel: mm)											
31-32	0.8	5.5	5.8	28.2 (Travel: mm)													
HS6B-12	2NC-1NO 	<table border="1"> <tr> <td>11-12</td> <td>0.8</td> <td>5.5</td> <td>5.8</td> <td>28.2 (Travel: mm)</td> </tr> <tr> <td>21-22</td> <td>0.8</td> <td>5.5</td> <td>5.8</td> <td>28.2 (Travel: mm)</td> </tr> <tr> <td>33-34</td> <td>0.8</td> <td>5.5</td> <td>5.8</td> <td>28.2 (Travel: mm)</td> </tr> </table>	11-12	0.8	5.5	5.8	28.2 (Travel: mm)	21-22	0.8	5.5	5.8	28.2 (Travel: mm)	33-34	0.8	5.5	5.8	28.2 (Travel: mm)
		11-12	0.8	5.5	5.8	28.2 (Travel: mm)											
21-22	0.8	5.5	5.8	28.2 (Travel: mm)													
33-34	0.8	5.5	5.8	28.2 (Travel: mm)													
HS6B-03	3NC 	<table border="1"> <tr> <td>11-12</td> <td>0.8</td> <td>5.5</td> <td>5.8</td> <td>28.2 (Travel: mm)</td> </tr> <tr> <td>21-22</td> <td>0.8</td> <td>5.5</td> <td>5.8</td> <td>28.2 (Travel: mm)</td> </tr> <tr> <td>31-32</td> <td>0.8</td> <td>5.5</td> <td>5.8</td> <td>28.2 (Travel: mm)</td> </tr> </table>	11-12	0.8	5.5	5.8	28.2 (Travel: mm)	21-22	0.8	5.5	5.8	28.2 (Travel: mm)	31-32	0.8	5.5	5.8	28.2 (Travel: mm)
		11-12	0.8	5.5	5.8	28.2 (Travel: mm)											
21-22	0.8	5.5	5.8	28.2 (Travel: mm)													
31-32	0.8	5.5	5.8	28.2 (Travel: mm)													

Actuator inserted completely Actuator removed completely

: Contact ON (closed)
 : Contact OFF (open)

Minimum Radius of Hinged Door

- When using the interlock switch on hinged doors, refer to the minimum radius of doors shown below. When using on doors with small minimum radius, use the angle adjustable actuator (HS9Z-A65 and HS9Z-A66).

Note: Because deviation or dislocation of hinged doors may occur in actual applications, make sure of the correct operation before installation.

When using the HS9Z-A62 Right-angle Actuator

- When the door hinge is on the extension line of the interlock switch surface:

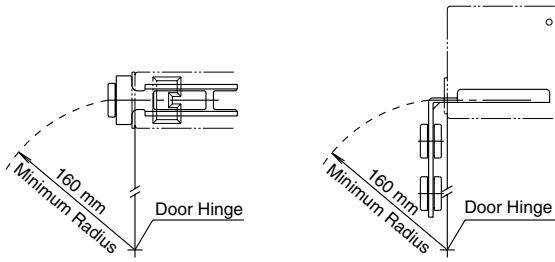

- When the door hinged is on the extension line of the actuator mounting surface:

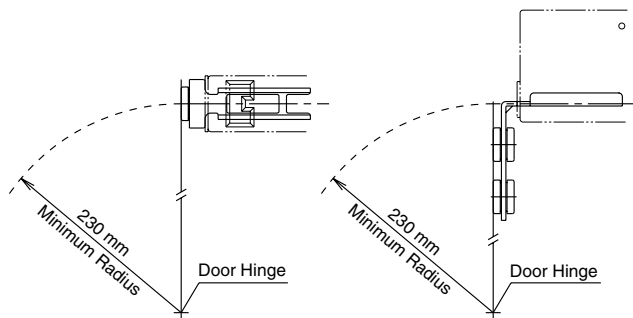

When using the HS9Z-A65/HS9Z-A66 Angle Adjustable Actuator

- When the door hinge is on the extension line of the interlock switch surface:

Horizontal Adjustment

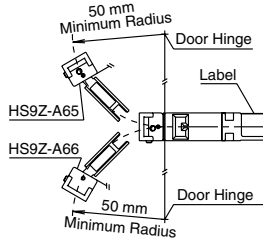

Vertical Adjustment

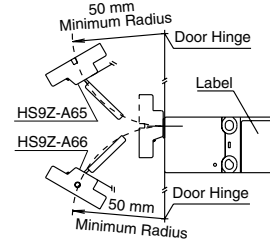

- When the door hinge is on the extension line of the actuator mounting surface:

Horizontal Adjustment

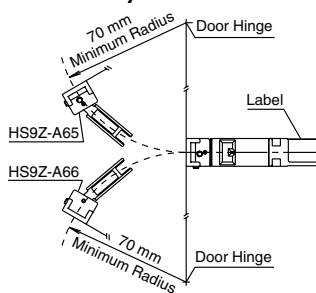

Vertical Adjustment

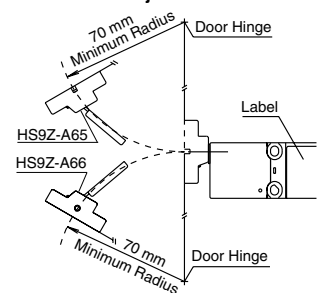

Actuator Angle Adjustment for the HS9Z-A65/HS9Z-A66

- Using the angle adjustment screw, the actuator angle can be adjusted (see figures on page 9). Adjustable angle: 0 to 20°
- The larger the adjusted angle of the actuator, the smaller the applicable radius of the door opening.
- After installing the actuator, open the door. Then adjust the actuator so that its edge can enter properly into the actuator entry slot of the interlock switch.
- After adjusting the actuator angle, apply Loctite to the adjustment screw so that the screw will not become loose.

HS6B Subminiature Interlock Switches

Safety Precautions

- In order to avoid electric shock or fire, turn power off before installation, removal, wiring, maintenance, or inspection of the interlock switch.
- If relays are used in the circuit between the interlock switch and the load, use only safety relays, since welded or sticking contacts of standard relays may invalidate the functions of the interlock switch. Perform a risk assessment and make a safety circuit which satisfies the requirements of the safety category.
- Do not place a PLC in the circuit between the interlock switch and the load. Safety security can be endangered in the event of a malfunction of the PLC.
- Do not disassemble or modify the interlock switch, otherwise a malfunction or an accident may occur.
- Do not install the actuator in the location where a human body may come into contact. Otherwise injury may occur.

Instructions

- Regardless of door types, do not use the interlock switch as a door stop. Install a mechanical door stop at the end of the door to protect the interlock switch against excessive force.
- Do not apply excessive shock to the interlock switch when opening or closing the door. A shock to the interlock switch exceeding $1,000 \text{ m/s}^2$ may cause damage to the interlock switch.
- If the operating atmosphere is contaminated, use a protective cover to prevent the entry of foreign objects into the interlock switch through the actuator entry slots.
- Entry of a considerable amount of foreign objects into the interlock switch may affect the mechanism of the interlock switch and cause a malfunction.
- Do not store the interlock switches in a dusty, humid, or organic-gas atmosphere.
- Use proprietary actuators only. When other actuators are used, the interlock switch may be damaged.
- Do not modify the actuator, otherwise it will damage the interlock switch.
- Cover the unused actuator entry slot using the slot plug supplied with the interlock switch.

Mounting

Mount the interlock switch on the machine. Mount the actuator on the hinged door.

Note: When mounting an actuator, make sure that the actuator enters into the slot in the correct direction, as shown on the right.

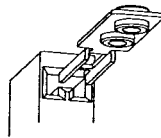

Recommended Screw Tightening Torque

- Interlock switch (M4 screw): 1.0 to 1.5 N·m
- Actuator (M4 screw): 1.0 to 1.5 N·m
- Mounting bolts are not supplied, and must be purchased separately by the user.

Note: The above recommended tightening torque of the mounting screw is the value with hex socket head bolts. When other screws are used and tightened to a smaller torque, make sure that the screws do not become loose after mounting.

Cable

- Do not fasten or loosen the gland at the bottom of the interlock switch.
- When bending cable during wiring, make sure that the cable radius is kept at 40 mm minimum.
- When wiring, make sure that water or oil does not enter from the end of cable.

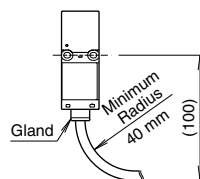

Wire Identification

- Wires can be identified by color and/or a white line printed on the wire.

No.	Insulation Color	No.	Insulation Color
1	Orange/White	4	Brown
2	Blue/White	5	Blue
3	Brown/White	6	Orange

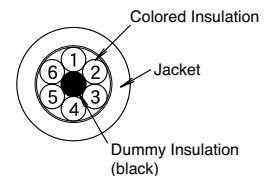

Terminal Number Identification

- When wiring, the terminal number on each contact can be identified by wire color.
- The following diagrams show a safety (main) contact and one or two auxiliary contacts for two-contact and three-contact types.

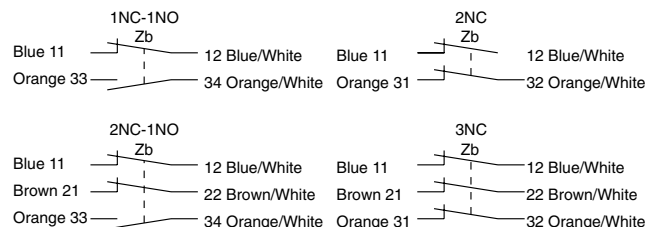

- When wiring, cut any dummy insulation (black) and any unused wires at the end of the jacket to avoid incorrect wiring.