



RFM Integrated Device, Inc.

PRODUCT SPECIFICATION

Part Number: CDR2008

DR Filter, Sub 6G/ 5th G, 3570
MHz, BW 100, IL 1.5

Halogen Free RoHS Compliant Product

ELECTRICAL CHARACTERISTICS:

This filter satisfies Table 1 at Temperature Range : -40 to +85°C

CENTER FREQUENCY :fo=3750 MHz

PASSBAND WIDTH :3700~3800 MHz

INPUT/OUTPUT IMPEDANCE :50Ω

Max. INPUT POWER : 10 W

Moisture Sensitivity Level: MSL2a

TABLE 1

NO.	ITEM		SPECIFICATION	
			Min	Max
1	PASS BAND INSERTION LOSS			1.5 dB
2	PASS BAND RIPPLE			1.0 dB
3	PASS BAND RETURN LOSS		10 dB	
4	STOP—BAND ATTENUATION	at 3350~3500 MHz	30 dB	
		at 4000~4150 MHz	30 dB	
Item NO.4 specifies the absolute value of attenuation.				

※Data is measured on the manufacturer's EVB board

TYPICAL ELECTRICAL CHARACTERISTICS

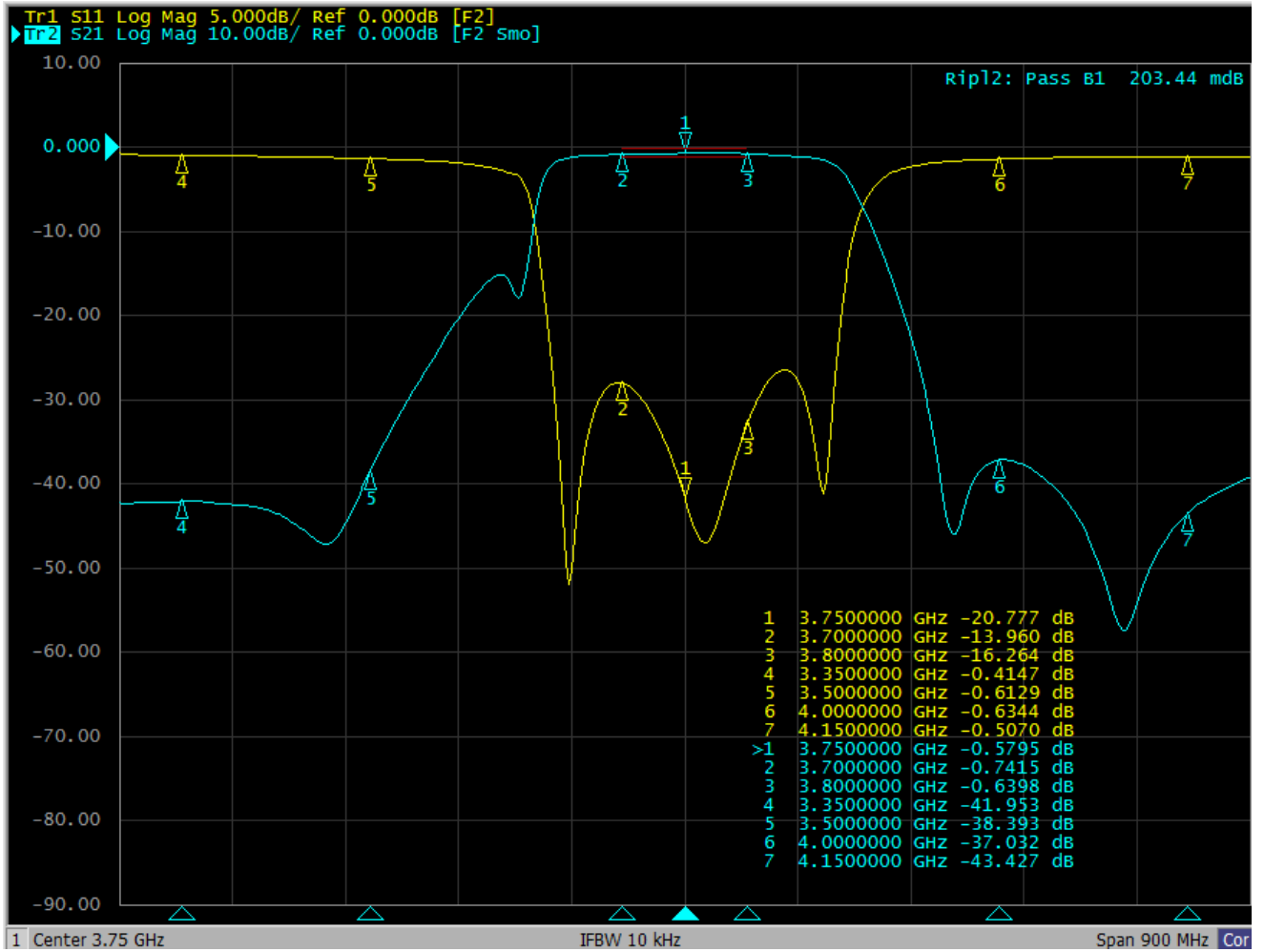

2. Recommended Reflow Soldering Profile

The products can be assembled following Pb-free assembly. According to the Standard **IPC/ JEDEC J-STD-020C**, the temperature profile suggested is as follow:

Phase	Profile features	Pb-Free Assembly (SnAgCu)
PREHEAT	-Temperature Min(T_{smin}) -Temperature Max(T_{smax}) -Time(t_s) form (T_{smin} to T_{smax})	150°C 200°C 60-120 seconds
RAMP-UP	Avg. Ramp-up Rate (T_{smax} to TP)	3°C/second(max)
REFLOW	-Temperature(T_L) -Total Time above T_L (t_L)	217°C 30-100 seconds
PEAK	-Temperature(T_P) -Time(t_p)	260°C 3 second
RAMP-DOWN	Rate	6°C / second max.
Time from 25°C to Peak Temperature		8 minutes max.
Composition of solder paste		96.5Sn/3Ag/0.5Cu
Solder Paste Model		SHENMAO PF606-P26

Note : All the temperature measure point is on top surface of the component, if temperature over recommend, it will make component surface peeling or damage.

The graphic shows temperature profile for component assembly process in reflow ovens

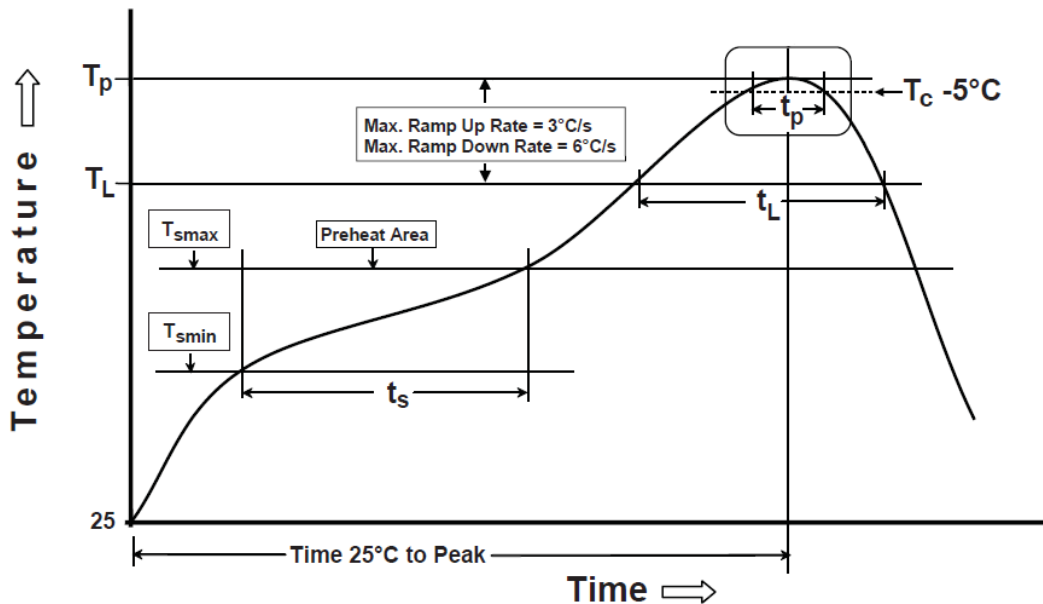

Soldering With Iron:

Soldering condition : Soldering iron temperature 270 ± 10 °C.

Apply preheating at 120°C for 2-3 minutes. Finish soldering for each terminal within 3 seconds, if soldering iron over temperature 270 ± 10 °C or 3 seconds, it will make component surface peeling or damage.

Soldering iron can not leakage of electricity.

3.DIMENSION AND PCB LAYOUT

3-1 SHAPE AND DIMENSION

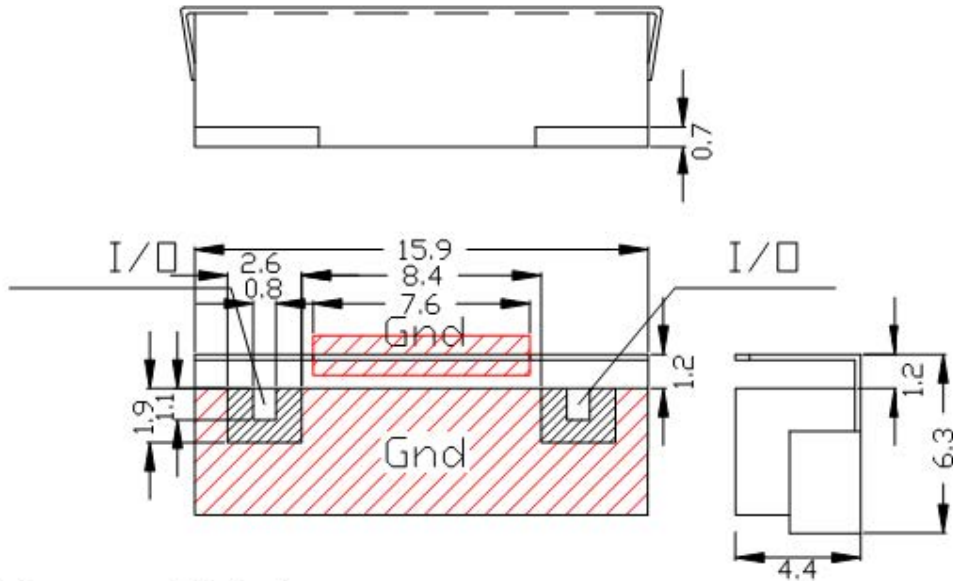

Case Material: Copper Nickel Alloy

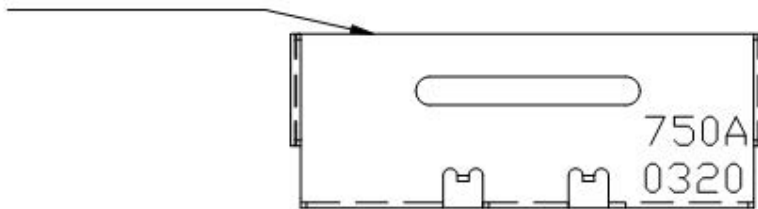

I/O: Input / Output
Gnd:Ground

750A: product name(J3750A)
0320: month/year(03/2020)
Color: Black

Unit:mm
Tolerance:±0.3

3-2 PCB RECOMMENDED PATTERN FOR FILTER

Note: Test PCB material: FR4 4.6, 1.0mm.

The filter use limit: the layout goes away PCB edge.

3-2-1
Conductive Material Patten

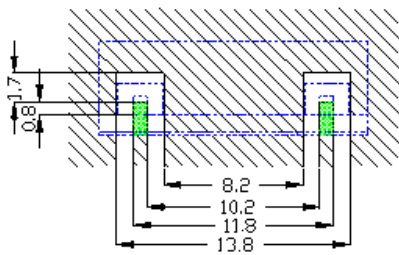

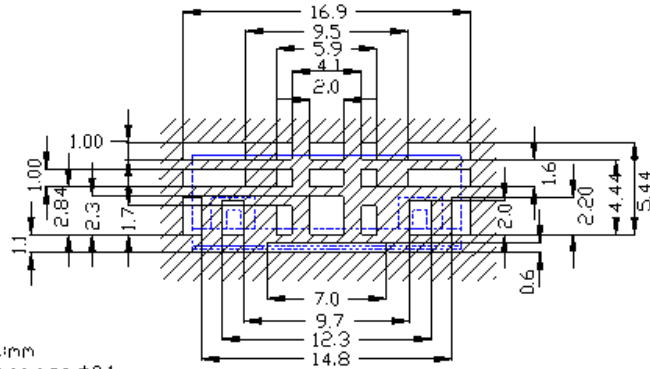

3-2-2
Solder resist Patten



Unit:mm
Tolerance:±0.1

 Conductive Material:
Ground,connected to
lower ground diameter of
0.3mm and max.distance
of3.0mm.

 I/D Pads must be
connected to lineswith
50Ω impedance.
in the application o
termination of 50Ω
must be realized.

 covered with solder
resist.