

Data sheet | Item number: 270-572/281-434

3-conductor actuator supply terminal block; LED (red); for PNP-(high-side) switching actuators; 2.5 mm<sup>2</sup>; CAGE CLAMP®; 2,50 mm<sup>2</sup>; gray

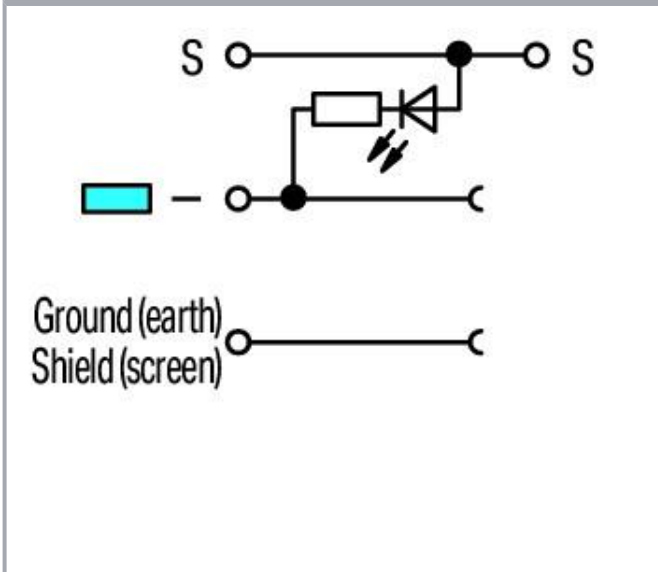

[www.wago.com/270-572/281-434](http://www.wago.com/270-572/281-434)

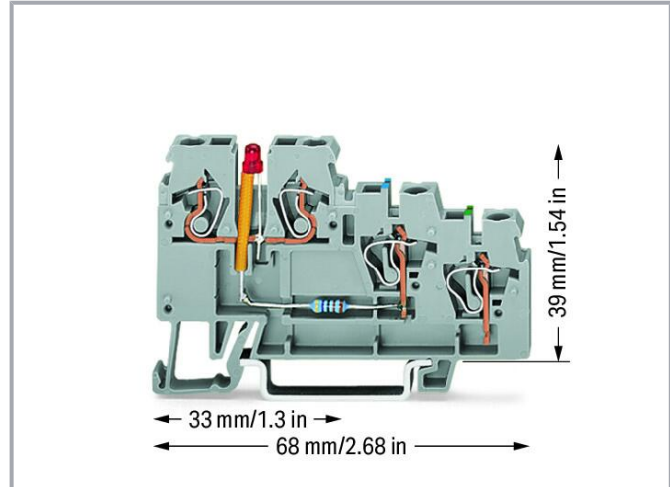
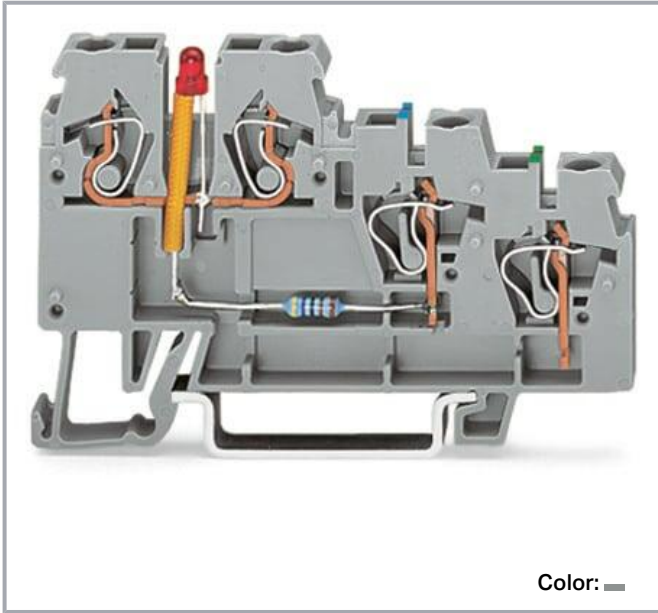

## Data

### Electrical data

Subject to changes. Please also observe the further product documentation!

WAGO GmbH & Co. KG  
Hansastr. 27  
32423 Minden  
Phone: +49571 887-0 | Fax: +49571 887-169  
Email: [info.de@wago.com](mailto:info.de@wago.com) | Web: [www.wago.com](http://www.wago.com)

Do you have any questions about our products?  
We are always happy to take your call at +49 (571) 887-44222.



## Ratings per IEC/EN

Note (rated current)

LED power consumption: 4.8 mA

## General

|                 |      |
|-----------------|------|
| Voltage type 1  | DC   |
| Nominal voltage | 24 V |

## Connection data

|                            |   |
|----------------------------|---|
| Connection points          | 4 |
| Total number of potentials | 3 |
| Number of levels           | 3 |

## Connection 1

|                                 |  |
|---------------------------------|--|
| Connection technology           | CAGE CLAMP®                                  |
| Actuation type                  | Operating tool                               |
| Connectable conductor materials | Copper                                       |
| Solid conductor                 | 0.08 ... 2.5 mm <sup>2</sup> / 28 ... 12 AWG |
| Fine-stranded conductor         | 0.08 ... 2.5 mm <sup>2</sup> / 28 ... 12 AWG |
| Note (conductor cross-section)  | 12 AWG: THHN, THWN                           |
| Strip length                    | 6 ... 7 mm / 0.24 ... 0.28 inches            |
| Wiring direction                | Front-entry wiring                           |

## Physical data

|                                   |                      |
|-----------------------------------|----------------------|
| Width                             | 5 mm / 0.197 inches  |
| Height                            | 68 mm / 2.677 inches |
| Depth from upper-edge of DIN-rail | 39 mm / 1.535 inches |

## Mechanical Data

|               |                 |
|---------------|-----------------|
| Design        | horizontal type |
| Mounting type | DIN-35 rail     |
| Marking level | Side marking    |

## Material Data

Note (material data)

[Information on material specifications can be found here](#)

Subject to changes. Please also observe the further product documentation!



|                             |                  |
|-----------------------------|------------------|
| Color                       | gray             |
| Material group              | I                |
| Insulation material         | Polyamide (PA66) |
| Flammability class per UL94 | V0               |
| Fire load                   | 0.178 MJ         |
| Weight                      | 10 g             |

### Environmental requirements

|                                  |                 |
|----------------------------------|-----------------|
| Processing temperature           | -35 ... +85 °C  |
| Continuous operating temperature | -60 ... +105 °C |

### Commercial data

|                       |                                  |
|-----------------------|----------------------------------|
| Product Group         | 1 (Rail Mounted Terminal Blocks) |
| eCl@ss 10.0           | 27-14-11-28                      |
| eCl@ss 9.0            | 27-14-11-28                      |
| ETIM 8.0              | EC000900                         |
| ETIM 7.0              | EC000900                         |
| PU (SPU)              | 50 pcs                           |
| Packaging type        | box                              |
| Country of origin     | CN                               |
| GTIN                  | 4050821286592                    |
| Customs tariff number | 85369010000                      |

### Environmental Product Compliance

|                        |                         |
|------------------------|-------------------------|
| RoHS Compliance Status | Compliant, No Exemption |
|------------------------|-------------------------|

### Approvals / Certificates

#### General approvals

| Logo | Approval                        | Additional Approval Text | Certificate name |
|------|---------------------------------|--------------------------|------------------|
|      | CCA<br>DEKRA Certification B.V. | EN 60947                 | NTR NL<br>6828   |
|      | CCA<br>DEKRA Certification B.V. | EN 60947                 | 2143311.03       |

Subject to changes. Please also observe the further product documentation!

WAGO GmbH & Co. KG  
 Hansastr. 27  
 32423 Minden  
 Phone: +49571 887-0 | Fax: +49571 887-169  
 Email: [info.de@wago.com](mailto:info.de@wago.com) | Web: [www.wago.com](http://www.wago.com)

Do you have any questions about our products?  
 We are always happy to take your call at +49 (571) 887-44222.



CSA  
DEKRA Certification B.V.

C22.2

1565649





UR  
Underwriters Laboratories Inc.

UL 1059

E45172

#### Declarations of conformity and manufacturer's declarations

| Logo  | Approval   | Additional Approval Text | Certificate name |
|---|--|--------------------------|------------------|
|   | EU-Declaration of Conformity<br>WAGO GmbH & Co. KG | -                        | -                |
|  | UK-Declaration of Conformity<br>WAGO GmbH & Co. KG | -                        | -                |

#### Required accessories

##### End plate

End plate



Item no.: 270-321

End and intermediate plate; 1 mm thick; for triple-deck terminal blocks; orange

[www.wago.com/270-321](http://www.wago.com/270-321)

Item no.: 270-319

End and intermediate plate; 1 mm thick; for triple-deck terminal blocks; gray

[www.wago.com/270-319](http://www.wago.com/270-319)

#### Optional accessories

##### Jumpers

Jumper



Item no.: 270-417

Jumper; 17-way; silver-colored

[www.wago.com/270-417](http://www.wago.com/270-417)

Item no.: 270-480

Jumper; 80-way; silver-colored

[www.wago.com/270-480](http://www.wago.com/270-480)

Subject to changes. Please also observe the further product documentation!

WAGO GmbH &amp; Co. KG

Hansastr. 27

32423 Minden

Phone: +49571 887-0 | Fax: +49571 887-169

Email: [info.de@wago.com](mailto:info.de@wago.com) | Web: [www.wago.com](http://www.wago.com)

Do you have any questions about our products?

We are always happy to take your call at +49 (571) 887-44222.



**Item no.: 270-409**  
Jumper; 9-way; silver-colored

[www.wago.com/270-409](http://www.wago.com/270-409)

**Marking accessories**

Marking strip



**Item no.: 709-196**  
Marking strips; for laser printer; translucent

[www.wago.com/709-196](http://www.wago.com/709-196)



**Item no.: 709-178**  
Marking strips; on reel; 7.5 mm wide; not stretchable; plain; snap-on type; white

[www.wago.com/709-178](http://www.wago.com/709-178)



**Item no.: 709-177**  
Marking strips; on reel; 7.5 mm wide; not stretchable; plain; snap-on type; translucent

[www.wago.com/709-177](http://www.wago.com/709-177)

Marker



**Item no.: 2009-115/000-002**  
WMB-Inline; for Smart Printer; 1500 pieces on roll; stretchable 5 - 5.2 mm; plain; snap-on type; yellow

[www.wago.com/2009-115/000-002](http://www.wago.com/2009-115/000-002)



**Item no.: 2009-115/000-007**  
WMB-Inline; for Smart Printer; 1500 pieces on roll; stretchable 5 - 5.2 mm; plain; snap-on type; gray

[www.wago.com/2009-115/000-007](http://www.wago.com/2009-115/000-007)



**Item no.: 2009-115/000-017**  
WMB-Inline; for Smart Printer; 1500 pieces on roll; stretchable 5 - 5.2 mm; plain; snap-on type; light green

[www.wago.com/2009-115/000-017](http://www.wago.com/2009-115/000-017)



**Item no.: 2009-115/000-023**  
WMB-Inline; for Smart Printer; 1500 pieces on roll; stretchable 5 - 5.2 mm; plain; snap-on type; green

[www.wago.com/2009-115/000-023](http://www.wago.com/2009-115/000-023)



**Item no.: 2009-115/000-024**  
WMB-Inline; for Smart Printer; 1500 pieces on roll; stretchable 5 - 5.2 mm; plain; snap-on type; violet

[www.wago.com/2009-115/000-024](http://www.wago.com/2009-115/000-024)



**Item no.: 2009-145/000-006**  
Mini-WSB Inline; for Smart Printer; 1700 pieces on roll; stretchable 5 - 5.2 mm; plain; snap-on type; blue

[www.wago.com/2009-145/000-006](http://www.wago.com/2009-145/000-006)



**Item no.: 2009-145**  
Mini-WSB Inline; for Smart Printer; 1700 pieces on roll; stretchable 5 - 5.2 mm; plain; snap-on type; white







[www.wago.com/2009-145](http://www.wago.com/2009-145)



**Item no.: 2009-145/000-002**  
Mini-WSB Inline; for Smart Printer; 1700 pieces on roll; stretchable 5 - 5.2 mm; plain; snap-on type; yellow

[www.wago.com/2009-145/000-002](http://www.wago.com/2009-145/000-002)

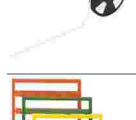
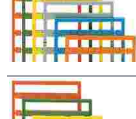
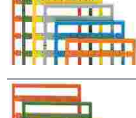
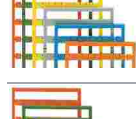
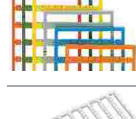
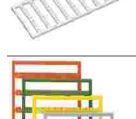
Subject to changes. Please also observe the further product documentation!

|  |   |  |
|--|---|--|
|    | <p><b>Item no.: 2009-145/000-007</b><br/>Mini-WSB Inline; for Smart Printer; 1700 pieces on roll; stretchable 5 - 5.2 mm; plain; snap-on type; gray</p>   | <a href="http://www.wago.com/2009-145/000-007">www.wago.com/2009-145/000-007</a> |
|    | <p><b>Item no.: 2009-145/000-005</b><br/>Mini-WSB Inline; for Smart Printer; 1700 pieces on roll; stretchable 5 - 5.2 mm; plain; snap-on type; red</p>    | <a href="http://www.wago.com/2009-145/000-005">www.wago.com/2009-145/000-005</a> |
|    | <p><b>Item no.: 2009-145/000-012</b><br/>Mini-WSB Inline; for Smart Printer; 1700 pieces on roll; stretchable 5 - 5.2 mm; plain; snap-on type; orange</p> | <a href="http://www.wago.com/2009-145/000-012">www.wago.com/2009-145/000-012</a> |
|    | <p><b>Item no.: 2009-145/000-023</b><br/>Mini-WSB Inline; for Smart Printer; 1700 pieces on roll; stretchable 5 - 5.2 mm; plain; snap-on type; green</p>  | <a href="http://www.wago.com/2009-145/000-023">www.wago.com/2009-145/000-023</a> |
|    | <p><b>Item no.: 2009-145/000-024</b><br/>Mini-WSB Inline; for Smart Printer; 1700 pieces on roll; stretchable 5 - 5.2 mm; plain; snap-on type; violet</p> | <a href="http://www.wago.com/2009-145/000-024">www.wago.com/2009-145/000-024</a> |
|    | <p><b>Item no.: 2009-115</b><br/>WMB-Inline; for Smart Printer; 1500 pieces on roll; stretchable 5 - 5.2 mm; plain; snap-on type; white</p>               | <a href="http://www.wago.com/2009-115">www.wago.com/2009-115</a>                 |
|   | <p><b>Item no.: 248-501/000-006</b><br/>Mini-WSB marking card; as card; not stretchable; plain; snap-on type; blue</p>                                    | <a href="http://www.wago.com/248-501/000-006">www.wago.com/248-501/000-006</a>   |
|  | <p><b>Item no.: 248-501/000-007</b><br/>Mini-WSB marking card; as card; not stretchable; plain; snap-on type; gray</p>                                    | <a href="http://www.wago.com/248-501/000-007">www.wago.com/248-501/000-007</a>   |
|  | <p><b>Item no.: 248-501/000-002</b><br/>Mini-WSB marking card; as card; not stretchable; plain; snap-on type; yellow</p>                                  | <a href="http://www.wago.com/248-501/000-002">www.wago.com/248-501/000-002</a>   |
|  | <p><b>Item no.: 248-501/000-012</b><br/>Mini-WSB marking card; as card; not stretchable; plain; snap-on type; orange</p>                                  | <a href="http://www.wago.com/248-501/000-012">www.wago.com/248-501/000-012</a>   |
|  | <p><b>Item no.: 248-501</b><br/>Mini-WSB marking card; as card; not stretchable; plain; snap-on type; white</p>   | <a href="http://www.wago.com/248-501">www.wago.com/248-501</a>                   |
|  | <p><b>Item no.: 248-501/000-017</b><br/>Mini-WSB marking card; as card; not stretchable; plain; snap-on type; light green</p>                             | <a href="http://www.wago.com/248-501/000-017">www.wago.com/248-501/000-017</a>   |

Subject to changes. Please also observe the further product documentation!



**Item no.:** 248-501/000-005  
Mini-WSB marking card; as card; not stretchable; plain; snap-on type; red

[www.wago.com/248-501/000-005](http://www.wago.com/248-501/000-005)



**Item no.:** 248-501/000-024  
Mini-WSB marking card; as card; not stretchable; plain; snap-on type; violet

[www.wago.com/248-501/000-024](http://www.wago.com/248-501/000-024)



**Item no.:** 248-501/000-023  
Mini-WSB marking card; as card; not stretchable; plain; snap-on type; green

[www.wago.com/248-501/000-023](http://www.wago.com/248-501/000-023)



**Item no.:** 793-5501/000-007  
WMB marking card; as card; for terminal block width 5 - 17.5 mm; stretchable 5 - 5.2 mm; plain; snap-on type; gray

[www.wago.com/793-5501/000-007](http://www.wago.com/793-5501/000-007)



**Item no.:** 793-5501/000-012  
WMB marking card; as card; for terminal block width 5 - 17.5 mm; stretchable 5 - 5.2 mm; plain; snap-on type; orange

[www.wago.com/793-5501/000-012](http://www.wago.com/793-5501/000-012)



**Item no.:** 793-5501/000-017  
WMB marking card; as card; for terminal block width 5 - 17.5 mm; stretchable 5 - 5.2 mm; plain; snap-on type; light green

[www.wago.com/793-5501/000-017](http://www.wago.com/793-5501/000-017)



**Item no.:** 793-5501/000-023  
WMB marking card; as card; for terminal block width 5 - 17.5 mm; stretchable 5 - 5.2 mm; plain; snap-on type; green

[www.wago.com/793-5501/000-023](http://www.wago.com/793-5501/000-023)



**Item no.:** 793-5501/000-024  
WMB marking card; as card; for terminal block width 5 - 17.5 mm; stretchable 5 - 5.2 mm; plain; snap-on type; violet

[www.wago.com/793-5501/000-024](http://www.wago.com/793-5501/000-024)



**Item no.:** 793-501/000-002  
WMB marking card; as card; not stretchable; plain; snap-on type; yellow

[www.wago.com/793-501/000-002](http://www.wago.com/793-501/000-002)



**Item no.:** 793-501/000-007  
WMB marking card; as card; not stretchable; plain; snap-on type; gray

[www.wago.com/793-501/000-007](http://www.wago.com/793-501/000-007)

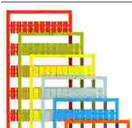

**Item no.:** 793-501/000-017  
WMB marking card; as card; not stretchable; plain; snap-on type; light green

[www.wago.com/793-501/000-017](http://www.wago.com/793-501/000-017)

Subject to changes. Please also observe the further product documentation!



**Item no.: 793-501/000-012**  
WMB marking card; as card; not stretchable; plain; snap-on type; orange

[www.wago.com/793-501/000-012](http://www.wago.com/793-501/000-012)



**Item no.: 793-501/000-023**  
WMB marking card; as card; not stretchable; plain; snap-on type; green

[www.wago.com/793-501/000-023](http://www.wago.com/793-501/000-023)



**Item no.: 793-501/000-006**  
WMB marking card; as card; not stretchable; plain; snap-on type; blue

[www.wago.com/793-501/000-006](http://www.wago.com/793-501/000-006)



**Item no.: 793-501/000-005**  
WMB marking card; as card; not stretchable; plain; snap-on type; red

[www.wago.com/793-501/000-005](http://www.wago.com/793-501/000-005)



**Item no.: 793-501**  
WMB marking card; as card; not stretchable; plain; snap-on type; white

[www.wago.com/793-501](http://www.wago.com/793-501)



**Item no.: 793-501/000-024**  
WMB marking card; as card; not stretchable; plain; snap-on type; violet

[www.wago.com/793-501/000-024](http://www.wago.com/793-501/000-024)



**Item no.: 793-5501/000-005**  
WMB marking card; as card; for terminal block width 5 - 17.5 mm; stretchable 5 - 5.2 mm; plain; snap-on type; red

[www.wago.com/793-5501/000-005](http://www.wago.com/793-5501/000-005)



**Item no.: 793-5501/000-002**  
WMB marking card; as card; for terminal block width 5 - 17.5 mm; stretchable 5 - 5.2 mm; plain; snap-on type; yellow

[www.wago.com/793-5501/000-002](http://www.wago.com/793-5501/000-002)



**Item no.: 793-5501/000-006**  
WMB marking card; as card; for terminal block width 5 - 17.5 mm; stretchable 5 - 5.2 mm; plain; snap-on type; blue

[www.wago.com/793-5501/000-006](http://www.wago.com/793-5501/000-006)



**Item no.: 793-5501**  
WMB marking card; as card; for terminal block width 5 - 17.5 mm; stretchable 5 - 5.2 mm; plain; snap-on type; white

[www.wago.com/793-5501](http://www.wago.com/793-5501)



**Item no.: 2009-115/000-012**  
WMB-Inline; for Smart Printer; 1500 pieces on roll; stretchable 5 - 5.2 mm; plain; snap-on type; orange

[www.wago.com/2009-115/000-012](http://www.wago.com/2009-115/000-012)

Subject to changes. Please also observe the further product documentation!





Item no.: 2009-115/000-006

WMB-Inline; for Smart Printer; 1500 pieces on roll; stretchable 5 - 5.2 mm; plain; snap-on type; blue

[www.wago.com/2009-115/000-006](http://www.wago.com/2009-115/000-006)













---

**Ferrule**

---

**Ferrule**

---

|   |  |  |
|---|--|--|
|    | <b>Item no.: 216-123</b><br>Ferrule; Sleeve for 1 mm <sup>2</sup> / AWG 18; uninsulated; electro-tin plated; silver-colored    | <a href="http://www.wago.com/216-123">www.wago.com/216-123</a> |
|    | <b>Item no.: 216-122</b><br>Ferrule; Sleeve for 0.75 mm <sup>2</sup> / AWG 20; uninsulated; electro-tin plated; silver-colored | <a href="http://www.wago.com/216-122">www.wago.com/216-122</a> |
|    | <b>Item no.: 216-124</b><br>Ferrule; Sleeve for 1.5 mm <sup>2</sup> / AWG 16; uninsulated; electro-tin plated                  | <a href="http://www.wago.com/216-124">www.wago.com/216-124</a> |
|    | <b>Item no.: 216-132</b><br>Ferrule; Sleeve for 0.34 mm <sup>2</sup> / AWG 24; uninsulated; electro-tin plated                 | <a href="http://www.wago.com/216-132">www.wago.com/216-132</a> |
|    | <b>Item no.: 216-121</b><br>Ferrule; Sleeve for 0.5 mm <sup>2</sup> / AWG 22; uninsulated; electro-tin plated; silver-colored  | <a href="http://www.wago.com/216-121">www.wago.com/216-121</a> |
|    | <b>Item no.: 216-131</b><br>Ferrule; Sleeve for 0.25 mm <sup>2</sup> / AWG 24; uninsulated; electro-tin plated; silver-colored | <a href="http://www.wago.com/216-131">www.wago.com/216-131</a> |
|    | <b>Item no.: 216-223</b><br>Ferrule; Sleeve for 1 mm <sup>2</sup> / AWG 18; insulated; electro-tin plated; red                 | <a href="http://www.wago.com/216-223">www.wago.com/216-223</a> |
|   | <b>Item no.: 216-222</b><br>Ferrule; Sleeve for 0.75 mm <sup>2</sup> / 18 AWG; insulated; electro-tin plated; gray             | <a href="http://www.wago.com/216-222">www.wago.com/216-222</a> |
|  | <b>Item no.: 216-221</b><br>Ferrule; Sleeve for 0.5 mm <sup>2</sup> / 20 AWG; insulated; electro-tin plated; white             | <a href="http://www.wago.com/216-221">www.wago.com/216-221</a> |
|  | <b>Item no.: 216-224</b><br>Ferrule; Sleeve for 1.5 mm <sup>2</sup> / AWG 16; insulated; electro-tin plated; black             | <a href="http://www.wago.com/216-224">www.wago.com/216-224</a> |
|  | <b>Item no.: 216-321</b><br>Ferrule; Sleeve for 0.25 mm <sup>2</sup> / AWG 24; insulated; electro-tin plated; yellow           | <a href="http://www.wago.com/216-321">www.wago.com/216-321</a> |
|  | <b>Item no.: 216-322</b><br>Ferrule; Sleeve for 0.34 mm <sup>2</sup> / 22 AWG; insulated; electro-tin plated; light turquoise  | <a href="http://www.wago.com/216-322">www.wago.com/216-322</a> |



---

**Insulation stop**

---

**Insulation stop**

---

|  |  |  |
|--|--|--|
|  | <b>Item no.: 280-472</b><br>Insulation stop; 0.75 - 1 mm <sup>2</sup> ; 5 pieces/strip; black                                    | <a href="http://www.wago.com/280-472">www.wago.com/280-472</a> |
|  | <b>Item no.: 280-470</b><br>Insulation stop; 0.08 - 0.2 mm <sup>2</sup> "s" (0.14 mm <sup>2</sup> "f-st"); 5 pieces/strip; white | <a href="http://www.wago.com/280-470">www.wago.com/280-470</a> |
|  | <b>Item no.: 280-471</b><br>Insulation stop; 0.25 - 0.5 mm <sup>2</sup> ; 5 pieces/strip; light gray                             | <a href="http://www.wago.com/280-471">www.wago.com/280-471</a> |

Subject to changes. Please also observe the further product documentation!

WAGO GmbH &amp; Co. KG

Hansastr. 27

32423 Minden

Phone: +49571 887-0 | Fax: +49571 887-169

Email: [info.de@wago.com](mailto:info.de@wago.com) | Web: [www.wago.com](http://www.wago.com)

Do you have any questions about our products?

We are always happy to take your call at +49 (571) 887-44222.

## Mounting

### Cover carrier

**Item no.: 709-167**

Cover carrier; Type 1; incl. fixing/retaining screws and knurled nut; suitable for 279 to 282 and 880 Series rail-mounted terminal blocks; suitable for 264 Series miniature rail-mounted terminal blocks; suitable for 270 Series sensor and actuator terminal blocks; gray

[www.wago.com/709-167](http://www.wago.com/709-167)

### Cover

**Item no.: 709-153**

Cover; Type 1; suitable for cover carrier, type 1; 1 m long; transparent

[www.wago.com/709-153](http://www.wago.com/709-153)

## Tool

### Operating tool

**Item no.: 210-657**

Operating tool; Blade: 3.5 x 0.5 mm; with a partially insulated shaft; short; multicoloured

[www.wago.com/210-657](http://www.wago.com/210-657)

**Item no.: 210-720**

Operating tool; Blade: 3.5 x 0.5 mm; with a partially insulated shaft; multicoloured

[www.wago.com/210-720](http://www.wago.com/210-720)

## Downloads

### Documentation

#### Bid Text

|                                |             |                |          |
|--------------------------------|-------------|----------------|----------|
| 270-572/281-434<br>X81 - Datei | 2019 Feb 19 | xml<br>3.3 kB  | Download |
| 270-572/281-434<br>doc - Datei | 2017 May 31 | doc<br>24.6 kB | Download |

#### Additional Information

|   |  |               |          |
|---|--|---------------|----------|
| Technical Section<br>Technical explanations |  | pdf<br>2.2 MB | Download |
|---|--|---------------|----------|

## CAD/CAE-Data

### CAD data

|                              |  |     |          |
|------------------------------|--|-----|----------|
| 2D/3D Models 270-572/281-434 |  | URL | Download |
|------------------------------|--|-----|----------|

### CAE data

EPLAN Data Portal 270-572/281-434

Subject to changes. Please also observe the further product documentation!

WAGO GmbH & Co. KG  
Hansastr. 27  
32423 Minden  
Phone: +49571 887-0 | Fax: +49571 887-169  
Email: [info.de@wago.com](mailto:info.de@wago.com) | Web: [www.wago.com](http://www.wago.com)

Do you have any questions about our products?  
We are always happy to take your call at +49 (571) 887-44222.

|                                   |                     |                          |
|-----------------------------------|---------------------|--------------------------|
|                                   | <a href="#">URL</a> | <a href="#">Download</a> |
| WSCAD Universe 270-572/281-434    | <a href="#">URL</a> | <a href="#">Download</a> |
| ZUKEN Portal 270-572/281-434      | <a href="#">URL</a> | <a href="#">Download</a> |
| EPLAN Data Portal 270-572/281-434 | <a href="#">URL</a> | <a href="#">Download</a> |
| WSCAD Universe 270-572/281-434    | <a href="#">URL</a> | <a href="#">Download</a> |

## Environmental Product Compliance

### Compliance Search

|  |                     |                          |
|--|---------------------|--------------------------|
| Environmental Product Compliance 270-572/281-434   | <a href="#">URL</a> | <a href="#">Download</a> |
| 3-conductor actuator supply terminal block; LED (red); for PNP-(high-side) switching actuators; 2.5 mm <sup>2</sup> ; CAGE CLAMP®; 2,50 mm <sup>2</sup> ; gray |                     |                          |

## Installation Notes

### Commoning

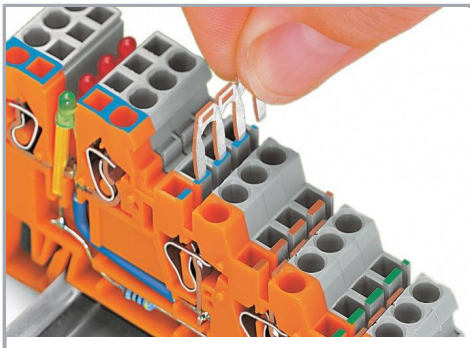

Inserting a jumper.

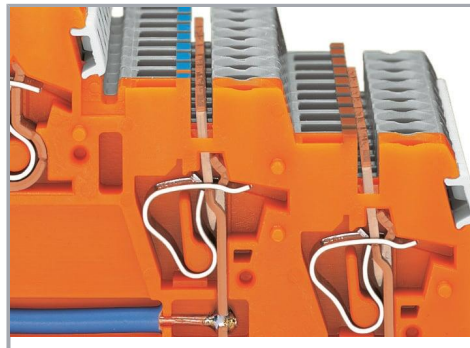

Commoning a supply voltage using uninsulated push-in type jumper bars, 2- to 9-way or 17-way (2 x 8 bits), depending on application.

Subject to changes. Please also observe the further product documentation!