

25A, 600V - 1000V Standard Bridge Rectifier

FEATURES

- Glass passivated chip junction
- Ideal for printed circuit board
- High surge current capability
- UL Recognized File # E-326243
- RoHS Compliant
- Halogen-free according to IEC 61249-2-21

APPLICATIONS

- Switching mode power supply (SMPS)
- Adapters
- Lighting application

MECHANICAL DATA

- Case: TS-6PL
- Molding compound meets UL 94V-0 flammability rating
- Terminal: Matte tin plated leads, solderable per J-STD-002
- Meet JESD 201 class 1 whisker test
- Mounting torque: 0.78 N·m maximum
- Polarity: As marked
- Weight: 4.40g (approximately)

| KEY PARAMETERS | | |
|----------------|------------|------|
| PARAMETER | VALUE | UNIT |
| I_F | 25 | A |
| V_{RRM} | 600 - 1000 | V |
| I_{FSM} | 312 | A |
| $T_{J\ MAX}$ | 150 | °C |
| Package | TS-6PL | |
| Configuration | Quad | |

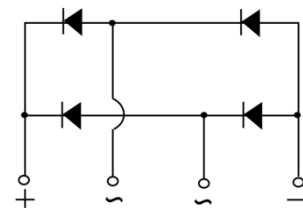
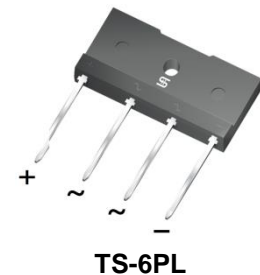

| ABSOLUTE MAXIMUM RATINGS ($T_A = 25^\circ\text{C}$ unless otherwise noted) | | | | | |
|--|--------------------|--------------|------------|------------|----------------------|
| PARAMETER | SYMBOL | T25JA05G-K | T25JA06G-K | T25JA07G-K | UNIT |
| Marking code on the device | | T25JA05G | T25JA06G | T25JA07G | |
| Repetitive peak reverse voltage | V_{RRM} | 600 | 800 | 1000 | V |
| Reverse voltage, total rms value | $V_{R(RMS)}$ | 420 | 560 | 700 | V |
| Forward current | I_F | 25 | | | A |
| Peak forward surge current, single half sine-wave superimposed on rated load | $t = 8.3\text{ms}$ | 312 | | | A |
| | $t = 1.0\text{ms}$ | 900 | | | A |
| Rating of fusing ($t < 8.3\text{ms}$) | I^2t | 404 | | | A^2s |
| Junction temperature | T_J | - 55 to +150 | | | °C |
| Storage temperature | T_{STG} | - 55 to +150 | | | °C |

| THERMAL PERFORMANCE | | | |
|--|-----------------|------------|-------------|
| PARAMETER | SYMBOL | TYP | UNIT |
| Junction-to-lead thermal resistance | $R_{\theta JL}$ | 4 | °C/W |
| Junction-to-ambient thermal resistance | $R_{\theta JA}$ | 14 | °C/W |
| Junction-to-case thermal resistance | $R_{\theta JC}$ | 5 | °C/W |

Thermal Performance Note: Mounted on heat sink size of 4" x 6" x 0.25" Al-plate

| ELECTRICAL SPECIFICATIONS ($T_A = 25^\circ\text{C}$ unless otherwise noted) | | | | | |
|---|---|---------------|------------|------------|---------------|
| PARAMETER | CONDITIONS | SYMBOL | TYP | MAX | UNIT |
| Forward voltage per diode ⁽¹⁾ | $I_F = 12.5\text{A}, T_J = 25^\circ\text{C}$ | V_F | 0.93 | - | V |
| | $I_F = 25.0\text{A}, T_J = 25^\circ\text{C}$ | | 1.08 | 1.15 | V |
| | $I_F = 12.5\text{A}, T_J = 125^\circ\text{C}$ | | 0.86 | - | V |
| | $I_F = 25.0\text{A}, T_J = 125^\circ\text{C}$ | | 0.98 | 1.09 | V |
| Reverse current @ rated V_R per diode ⁽²⁾ | $T_J = 25^\circ\text{C}$ | I_R | - | 5 | μA |
| | $T_J = 125^\circ\text{C}$ | | - | 380 | μA |
| Junction capacitance per diode | 1MHz, $V_R = 4.0\text{V}$ | C_J | 92.3 | - | pF |

Notes:

1. Pulse test with PW = 0.3ms
2. Pulse test with PW = 30ms

| ORDERING INFORMATION | | |
|------------------------------------|----------------|----------------|
| ORDERING CODE⁽¹⁾ | PACKAGE | PACKING |
| T25JA0xG-K | TS-6PL | 15 / Tube |

Notes:

1. "x" defines voltage from 600V(T25JA05G-K) to 1000V(T25JA07G-K)

CHARACTERISTICS CURVES

($T_A = 25^\circ\text{C}$ unless otherwise noted)

Fig.1 Forward Current Derating Curve

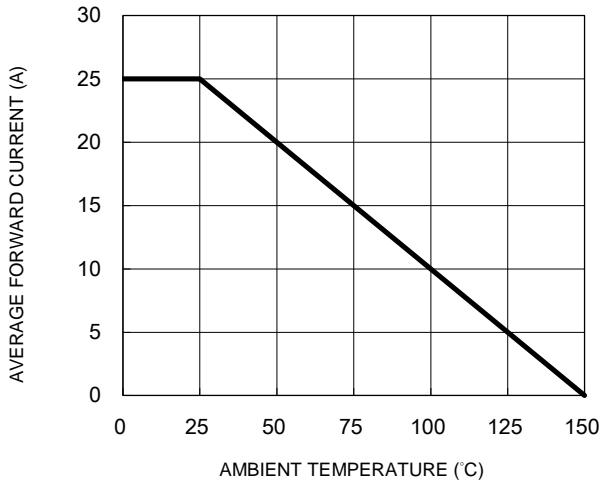

Fig.2 Typical Junction Capacitance

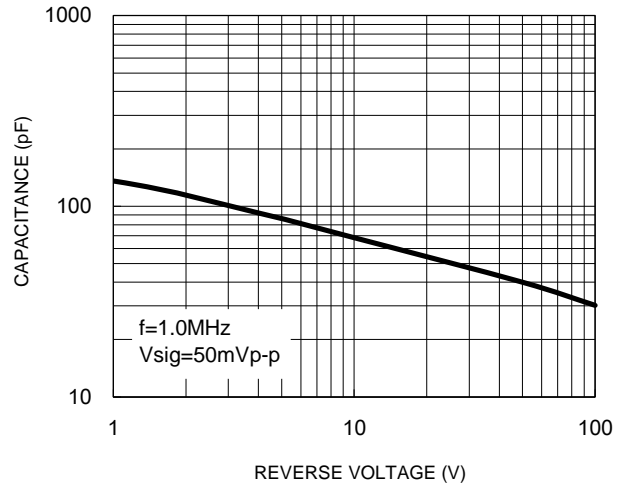

Fig.3 Typical Reverse Characteristics

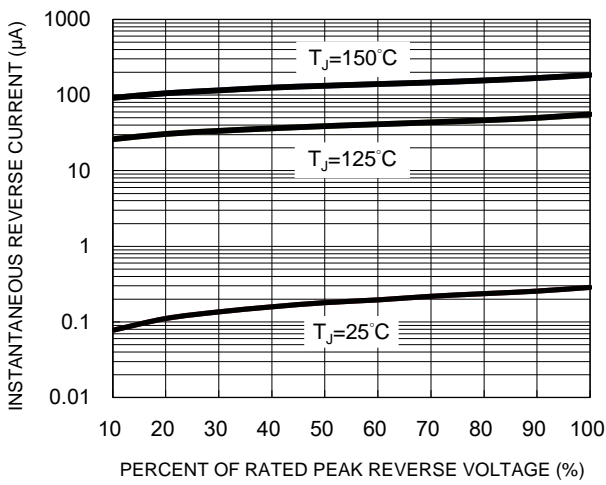
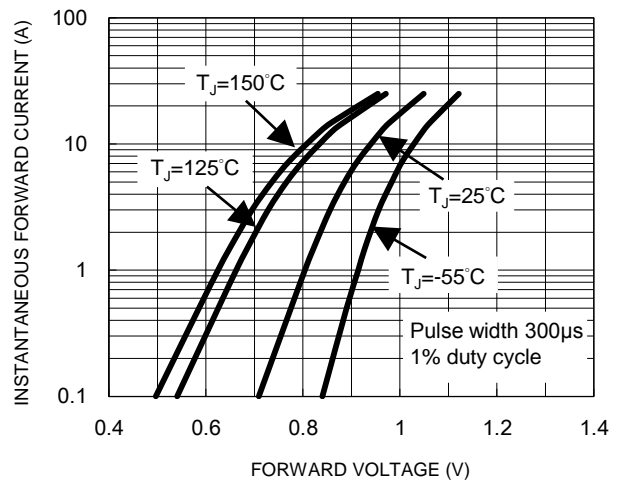
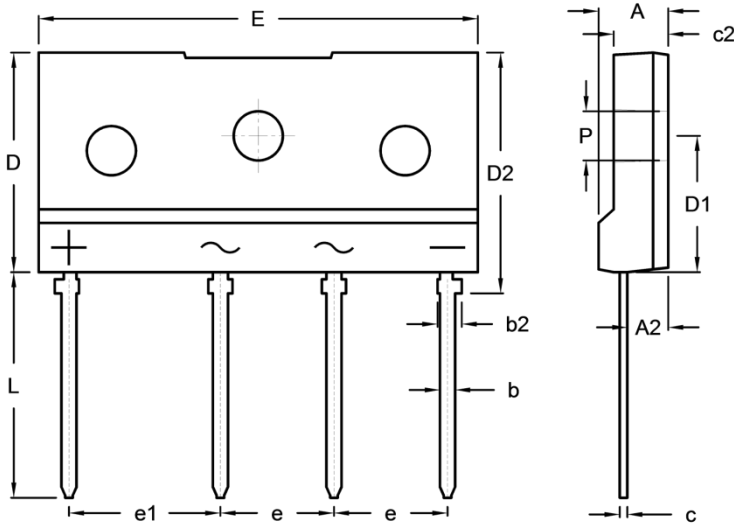

Fig.4 Typical Forward Characteristics



PACKAGE OUTLINE DIMENSIONS

TS-6PL



| DIM. | Unit (mm) | | Unit (inch) | |
|------|-----------|-------|-------------|-------|
| | Min. | Max. | Min. | Max. |
| A | 4.30 | 4.90 | 0.169 | 0.193 |
| A2 | 2.50 | 2.90 | 0.098 | 0.114 |
| b | 0.90 | 1.10 | 0.035 | 0.043 |
| b2 | 1.50 | 1.70 | 0.059 | 0.067 |
| c | 0.40 | 0.60 | 0.016 | 0.024 |
| c2 | 3.30 | 3.90 | 0.130 | 0.154 |
| D | 14.20 | 14.80 | 0.559 | 0.583 |
| D1 | 8.70 | 9.30 | 0.343 | 0.366 |
| D2 | 15.60 | 16.20 | 0.614 | 0.638 |
| E | 28.70 | 29.30 | 1.130 | 1.154 |
| e | 7.30 | 7.70 | 0.287 | 0.303 |
| e1 | 9.80 | 10.20 | 0.386 | 0.402 |
| L | 14.60 | 15.20 | 0.575 | 0.598 |
| P | 3.10 | 3.40 | 0.122 | 0.134 |

MARKING DIAGRAM

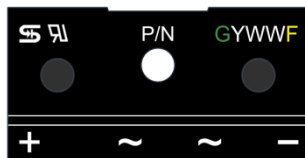

- P/N = Marking Code
- G = Green Compound
- YWW = Date Code
- F = Factory Code

Notice

Specifications of the products displayed herein are subject to change without notice. TSC or anyone on its behalf, assumes no responsibility or liability for any errors or inaccuracies.

Purchasers are solely responsible for the choice, selection, and use of TSC products and TSC assumes no liability for application assistance or the design of Purchasers' products.

Information contained herein is intended to provide a product description only. No license, express or implied, to any intellectual property rights is granted by this document. Except as provided in TSC's terms and conditions of sale for such products, TSC assumes no liability whatsoever, and disclaims any express or implied warranty, relating to sale and/or use of TSC products including liability or warranties relating to fitness for a particular purpose, merchantability, or infringement of any patent, copyright, or other intellectual property right.

The products shown herein are not designed for use in medical, life-saving, or life-sustaining applications. Customers using or selling these products for use in such applications do so at their own risk and agree to fully indemnify TSC for any damages resulting from such improper use or sale.