

SMBJ-HRA Series



Agency Approvals

Agency	Agency File Number
	E230531

Maximum Ratings and Thermal Characteristics (T_A=25°C unless otherwise noted)

Parameter	Symbol	Value	Unit
Peak Pulse Power Dissipation at T _A =25°C by 10/1000µs Waveform (Fig.2)(Note 1), (Note 2)	P _{PPM}	600	W
Power Dissipation on Infinite Heat Sink at T _A =50°C	P _{M(AV)}	5.0	W
Peak Forward Surge Current, 8.3ms Single Half Sine Wave (Note 3)	I _{FSM}	100	A
Maximum Instantaneous Forward Voltage at 50A for Unidirectional Only	V _F	3.5V	V
Operating Junction and Storage Temperature Range	T _J , T _{STG}	-65 to 150	°C
Typical Thermal Resistance Junction to Lead	R _{θJL}	20	°C/W
Typical Thermal Resistance Junction to Ambient	R _{θJA}	100	°C/W

Notes:
 1. Non-repetitive current pulse per Fig. 4 and derated above T_A = 25°C per Fig. 3.
 2. Mounted on copper pad area of 0.2x0.2" (5.0 x 5.0mm) to each terminal.
 3. Measured on 8.3ms single half sine wave or equivalent square wave for unidirectional device only, duty cycle=4 per minute maximum.

Functional Diagram

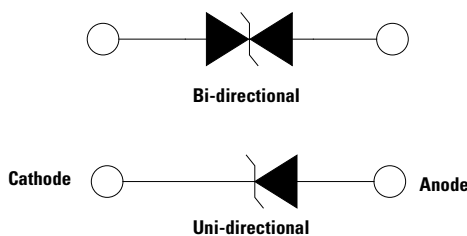

Description

The SMBJ-HRA High Reliability series is designed specifically to protect sensitive electronic equipment from voltage transients induced by lightning and other transient voltage events.

Features

- 600W peak pulse power capability at 10/1000µs waveform, repetition rate (duty cycles):0.01 %
- Excellent clamping capability
- Low incremental surge resistance
- Typical I_R less than 1µA above 12V
- For surface mounted applications to optimize board space
- Low profile package
- Typical failure mode is short from over-specified voltage or current
- Whisker test is conducted based on JEDEC JESD201A per its table 4a and 4c
- IEC 61000-4-2 ESD 15kV(Air), 8kV (Contact)
- ESD protection of data lines in accordance with IEC 61000-4-2
- EFT protection of data lines in accordance with IEC 61000-4-4
- Built-in strain relief
- Fast response time: typically less than 1.0ps from 0V to BV min
- V_{BR} @ T_J = V_{BR} @ 25°C x (1 + αT x (T_J - 25)) (αT: Temperature Coefficient, typical value is 0.1 %)
- Glass passivated chip junction
- High temperature soldering guaranteed: 260°C/40 seconds at terminals
- Plastic package is flammability rated V-0 per UL 94
- Meet MSL level1, per J-STD-020, LF maximum peak of 260°C.
- Matte tin lead-free plated
- Halogen free and RoHS compliant
- Pb-free E3 means 2nd level interconnect is Pb-free and the terminal finish material is tin(Sn) (IPC/ JEDEC J-STD-609A.01)
- UL Recognized to ANSI/UL 497B, "Protectors for Data Communications and Fire-Alarm Circuits."

Applications

TVS Components are ideal for the protection of I/O Interfaces, V_{CC} bus and other vulnerable circuits used in Telecom, Computer, Industrial and Consumer electronic applications.

Electrical Characteristics ($T_A=25^{\circ}\text{C}$ unless otherwise noted)

Part Number (Uni)	Part Number (Bi)	Marking		Reverse Stand off Voltage V_R (Volts)	Breakdown Voltage V_{BR} (Volts) @ I_T		Test Current I_T (mA)	Maximum Clamping Voltage V_C @ I_{PP} (V)	Maximum Peak Pulse Current I_{PP} (A)	Maximum Reverse Leakage I_R @ V_R (μA)	Agency Approval 
		UNI	BI		MIN	MAX					
SMBJ5.0A-HRA	SMBJ5.0CA-HRA	KEH	AEH	5.0	6.40	7.00	10	9.2	65.3	800	X
SMBJ6.0A-HRA	SMBJ6.0CA-HRA	KGH	AGH	6.0	6.67	7.37	10	10.3	58.3	800	X
SMBJ6.5A-HRA	SMBJ6.5CA-HRA	KKH	AKH	6.5	7.22	7.98	10	11.2	53.6	500	X
SMBJ7.0A-HRA	SMBJ7.0CA-HRA	KMH	AMH	7.0	7.78	8.60	10	12.0	50.0	200	X
SMBJ7.5A-HRA	SMBJ7.5CA-HRA	KPH	APH	7.5	8.33	9.21	1	12.9	46.6	100	X
SMBJ8.0A-HRA	SMBJ8.0CA-HRA	KRH	ARH	8.0	8.89	9.83	1	13.6	44.2	50	X
SMBJ8.5A-HRA	SMBJ8.5CA-HRA	KTH	ATH	8.5	9.44	10.40	1	14.4	41.7	20	X
SMBJ9.0A-HRA	SMBJ9.0CA-HRA	KVH	AVH	9.0	10.00	11.10	1	15.4	39.0	10	X
SMBJ10A-HRA	SMBJ10CA-HRA	KXH	AXH	10.0	11.10	12.30	1	17.0	35.3	5	X
SMBJ11A-HRA	SMBJ11CA-HRA	KZH	AZH	11.0	12.20	13.50	1	18.2	33.0	1	X
SMBJ12A-HRA	SMBJ12CA-HRA	LEH	BEH	12.0	13.30	14.70	1	19.9	30.2	1	X
SMBJ13A-HRA	SMBJ13CA-HRA	LGH	BGH	13.0	14.40	15.90	1	21.5	28.0	1	X
SMBJ14A-HRA	SMBJ14CA-HRA	LKH	BKH	14.0	15.60	17.20	1	23.2	25.9	1	X
SMBJ15A-HRA	SMBJ15CA-HRA	LMH	BMH	15.0	16.70	18.50	1	24.4	24.6	1	X
SMBJ16A-HRA	SMBJ16CA-HRA	LPH	BPH	16.0	17.80	19.70	1	26.0	23.1	1	X
SMBJ17A-HRA	SMBJ17CA-HRA	LRH	BRH	17.0	18.90	20.90	1	27.6	21.8	1	X
SMBJ18A-HRA	SMBJ18CA-HRA	LTH	BTH	18.0	20.00	22.10	1	29.2	20.6	1	X
SMBJ20A-HRA	SMBJ20CA-HRA	LVH	BVH	20.0	22.20	24.50	1	32.4	18.6	1	X
SMBJ22A-HRA	SMBJ22CA-HRA	LXH	BXH	22.0	24.40	26.90	1	35.5	16.9	1	X
SMBJ24A-HRA	SMBJ24CA-HRA	LZH	BZH	24.0	26.70	29.50	1	38.9	15.5	1	X
SMBJ26A-HRA	SMBJ26CA-HRA	MEH	CEH	26.0	28.90	31.90	1	42.1	14.3	1	X
SMBJ28A-HRA	SMBJ28CA-HRA	MGH	CGH	28.0	31.10	34.40	1	45.4	13.3	1	X
SMBJ30A-HRA	SMBJ30CA-HRA	MK H	CKH	30.0	33.30	36.80	1	48.4	12.4	1	X
SMBJ33A-HRA	SMBJ33CA-HRA	MMH	CMH	33.0	36.70	40.60	1	53.3	11.3	1	X
SMBJ36A-HRA	SMBJ36CA-HRA	MPH	CPH	36.0	40.00	44.20	1	58.1	10.4	1	X
SMBJ40A-HRA	SMBJ40CA-HRA	MRH	CRH	40.0	44.40	49.10	1	64.5	9.3	1	X
SMBJ43A-HRA	SMBJ43CA-HRA	MTH	CTH	43.0	47.80	52.80	1	69.4	8.7	1	X
SMBJ45A-HRA	SMBJ45CA-HRA	MVH	CVH	45.0	50.00	55.30	1	72.7	8.3	1	X
SMBJ48A-HRA	SMBJ48CA-HRA	MXH	CXH	48.0	53.30	58.90	1	77.4	7.8	1	X
SMBJ51A-HRA	SMBJ51CA-HRA	MZH	CZH	51.0	56.70	62.70	1	82.4	7.3	1	X
SMBJ54A-HRA	SMBJ54CA-HRA	NEH	DEH	54.0	60.00	66.30	1	87.1	6.9	1	X
SMBJ58A-HRA	SMBJ58CA-HRA	NGH	DGH	58.0	64.40	71.20	1	93.6	6.5	1	X
SMBJ60A-HRA	SMBJ60CA-HRA	NKH	DKH	60.0	66.70	73.70	1	96.8	6.2	1	X
SMBJ64A-HRA	SMBJ64CA-HRA	NMH	DMH	64.0	71.10	78.60	1	103.0	5.9	1	X
SMBJ70A-HRA	SMBJ70CA-HRA	NPH	DPH	70.0	77.80	86.00	1	113.0	5.3	1	X
SMBJ75A-HRA	SMBJ75CA-HRA	NRH	DRH	75.0	83.30	92.10	1	121.0	5.0	1	X
SMBJ78A-HRA	SMBJ78CA-HRA	NTH	DTH	78.0	86.70	95.80	1	126.0	4.8	1	X
SMBJ85A-HRA	SMBJ85CA-HRA	NVH	DVH	85.0	94.40	104.00	1	137.0	4.4	1	X
-	SMBJ90CA-HRA	-	DXH	90.0	100.00	111.00	1	146.0	4.1	1	X
-	SMBJ100CA-HRA	-	DZH	100.0	111.00	123.00	1	162.0	3.7	1	X
-	SMBJ110CA-HRA	-	EEH	110.0	122.00	135.00	1	177.0	3.4	1	X
-	SMBJ120CA-HRA	-	EGH	120.0	133.00	147.00	1	193.0	3.1	1	X
-	SMBJ130CA-HRA	-	EKH	130.0	144.00	159.00	1	209.0	2.9	1	X
-	SMBJ150CA-HRA	-	EMH	150.0	167.00	185.00	1	243.0	2.5	1	X
-	SMBJ160CA-HRA	-	EPH	160.0	178.00	197.00	1	259.0	2.3	1	X
-	SMBJ170CA-HRA	-	ERH	170.0	189.00	209.00	1	275.0	2.2	1	X

Screen Process

100% Vision Inspection	MIL-STD-750 method 2074
100% High Temperature Storage Life (168hrs,175°C)	MIL-STD-750 method 1031
100% X-RAY inspection	MIL-STD-750 method 2076
100% Temperature Cycle Test (-55 to 150°C, 20 cycles, dwell time 15 min)	MIL-STD-750 method 1051
100% Reflow (2x)	JEDEC J-STD-020
100% Surge Test (2x)	MIL-STD-750 method 4066
100% HTRB 150°C Bias=VR(80% breakdown voltage, 96hrs, and each direction 96hrs for Bi-directional products)	MIL-STD-750 method 1038
Final Electrical Test(100% 3 sigma limit, 100% dynamic test and PAT limit)	MIL-STD-750 method 4016.4021.4011

Note: Up-screen program can be specified by customer's request via contacting Littelfuse service

I-V Curve Characteristics

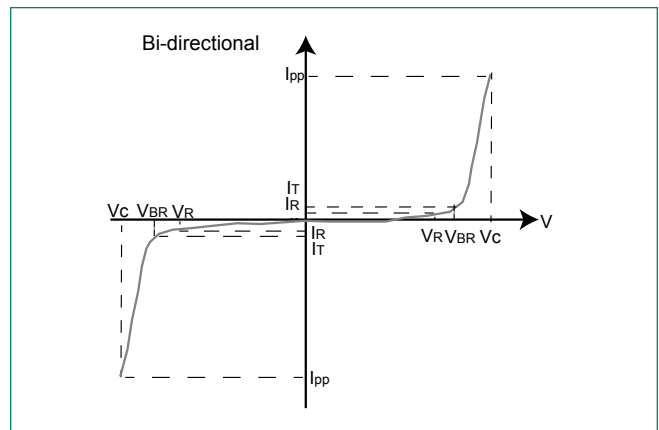
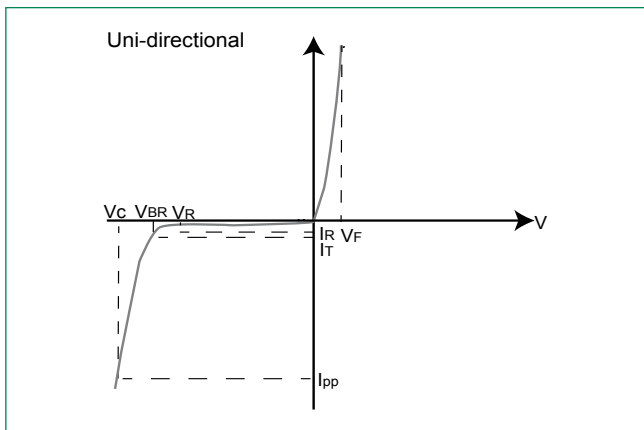

- P_{PPM}** Peak Pulse Power Dissipation – Max power dissipation
- V_R** Stand-off Voltage – Maximum voltage that can be applied to the TVS without operation
- V_{BR}** Breakdown Voltage – Maximum voltage that flows through the TVS at a specified test current (I_T)
- V_C** Clamping Voltage – Peak voltage measured across the suppressor at a specified I_{ppm} (peak impulse current)
- I_R** Reverse Leakage Current – Current measured at V_R
- V_F** Forward Voltage Drop for Uni-directional

Ratings and Characteristic Curves (T_A=25°C unless otherwise noted)

Figure 1 - TVS Transients Clamping Waveform

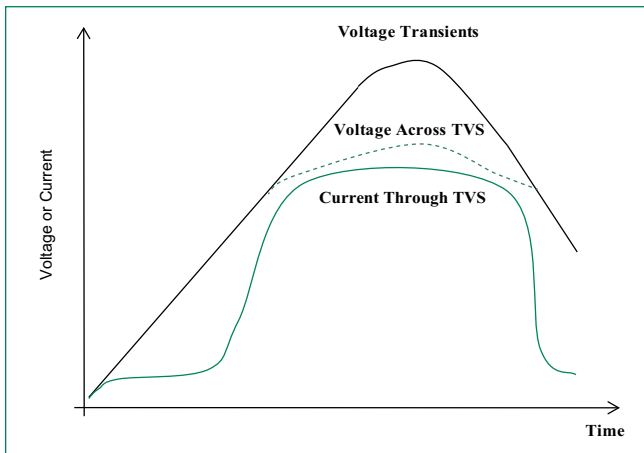
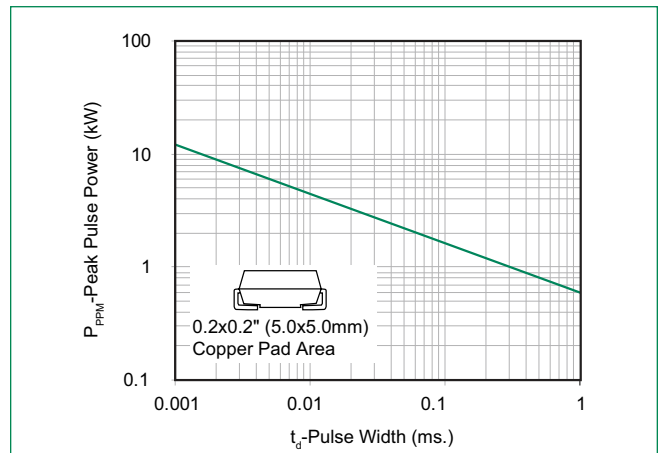

Figure 2 - Peak Pulse Power Rating



Ratings and Characteristic Curves ($T_A=25^\circ\text{C}$ unless otherwise noted) (Continued)

Figure 3 - Pulse Derating Curve

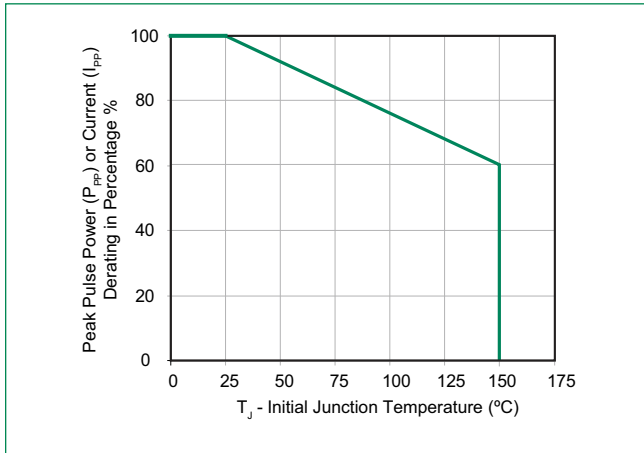

Figure 4 - Pulse Waveform

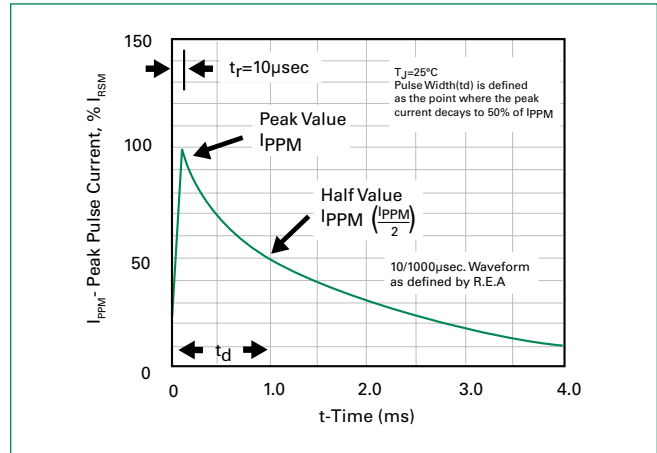

Figure 5 - Typical Junction Capacitance

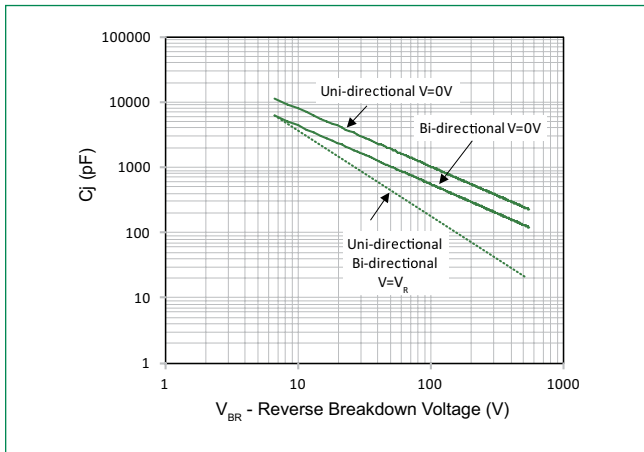

Figure 6 - Steady State Power Dissipation Derating Curve

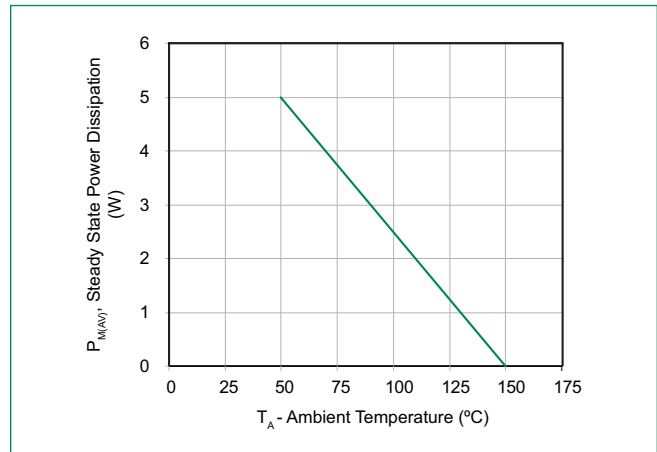
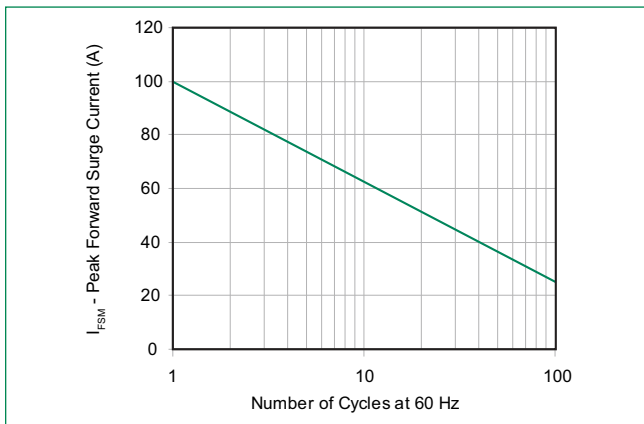
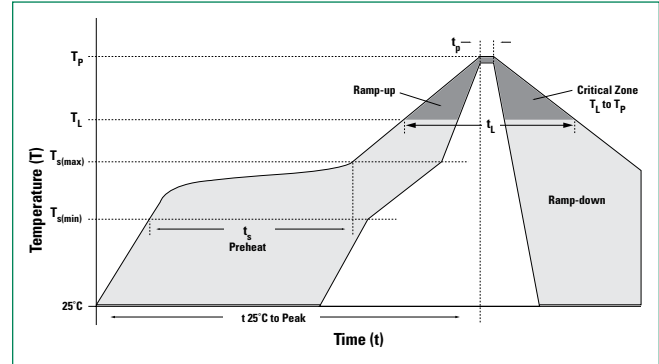

Figure 7 - Maximum Non-Repetitive Peak Forward Surge Current Uni-Directional Only



Soldering Parameters

Reflow Condition		Lead-free assembly
Pre Heat	- Temperature Min ($T_{s(min)}$)	150°C
	- Temperature Max ($T_{s(max)}$)	200°C
	- Time (min to max) (t_s)	60 – 180 secs
Average ramp up rate (Liquidus Temp (T_L) to peak)		3°C/second max
$T_{s(max)}$ to T_L - Ramp-up Rate		3°C/second max
Reflow	- Temperature (T_L) (Liquidus)	217°C
	- Time (min to max) (t_s)	60 – 150 seconds
Peak Temperature (T_p)		260 ^{+0/-5} °C
Time within 5°C of actual peak Temperature (t_p)		20 – 40 seconds
Ramp-down Rate		6°C/second max
Time 25°C to peak Temperature (T_p)		8 minutes Max.
Do not exceed		260°C



Physical Specifications

Weight	0.003 ounce, 0.093 grams
Case	JEDEC DO214AA. Molded plastic body over glass passivated junction
Polarity	Color band denotes cathode except Bidirectional
Terminal	Matte Tin-plated leads, Solderable per JESD22-B102

Environmental Specifications

High Temp. Storage	JESD22-A103
HTRB	JESD22-A108
Temperature Cycling	JESD22-A104
MSL	JEDEC-J-STD-020, Level 1
H3TRB	JESD22-A101
RSH	JESD22-A111

Dimensions

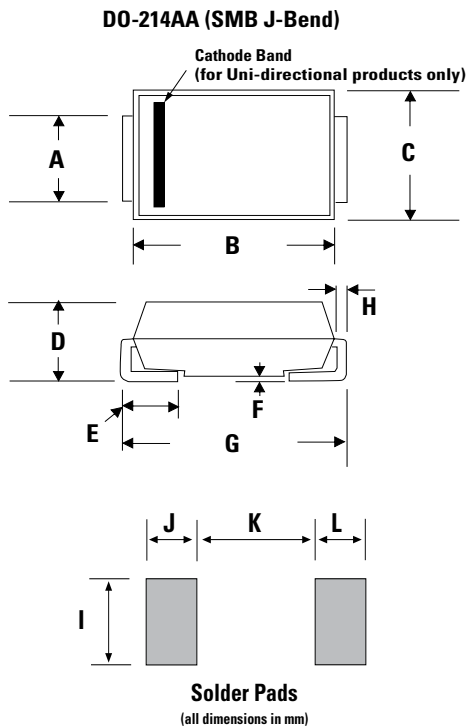

Dimensions	Inches		Millimeters	
	Min	Max	Min	Max
A	0.077	0.086	1.950	2.200
B	0.160	0.180	4.060	4.570
C	0.130	0.155	3.300	3.940
D	0.084	0.096	2.130	2.440
E	0.030	0.060	0.760	1.520
F	-	0.008	-	0.203
G	0.205	0.220	5.210	5.590
H	0.006	0.012	0.152	0.305
I	0.089	-	2.260	-
J	0.085	-	2.160	-
K	-	0.107	-	2.740
L	0.085	-	2.160	-

Part Numbering System

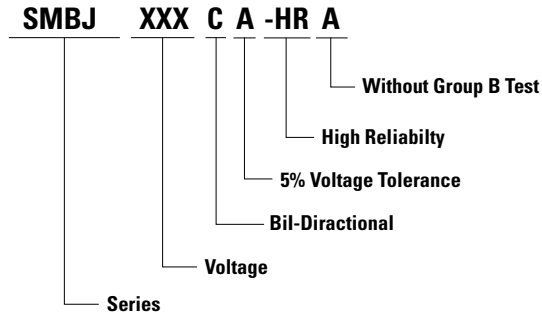

Part Marking System

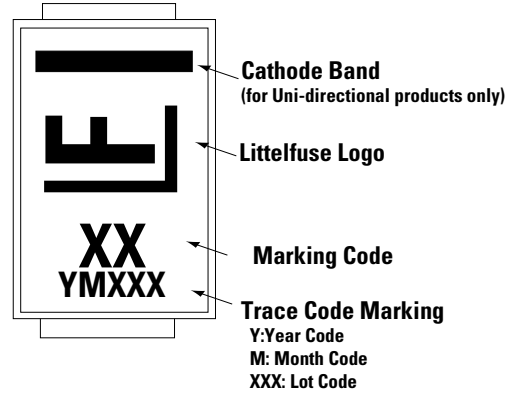

Packaging

Part number	Component Package	Quantity	Packaging Option	Packaging Specification
SMBJxxxXX-HRA	DO-214AA	3000	Tape & Reel - 12mm tape/13" reel	EIA STD RS-481

Tape and Reel Specification

