

## Data Sheet



### Description

This high intensity blue and green LEDs are based on the most efficient and cost effective InGaN material technology. This LED lamps is untinted and non-diffused, T-1 ¾ packages incorporating second-generation optics producing well defined spatial radiation patterns at specific viewing cone angles.

These lamps are made with an advanced optical grade epoxy, offering superior temperature and moisture resistance in outdoor signal and sign applications. The package epoxy contains both UV-A and UV-B inhibitors to reduce the effects of long term exposure to direct sunlight.

### Features

- Well defined spatial radiation pattern
- High luminous output
- Untinted, Non-diffused
- Viewing angle: 15°, 23° and 30°
- Standoff or non-standoff leads
- Superior resistance to moisture

### Applications

- Traffic signals
- Commercial outdoor advertising
- Front panel backlighting
- Front panel indicator

### Package Dimensions

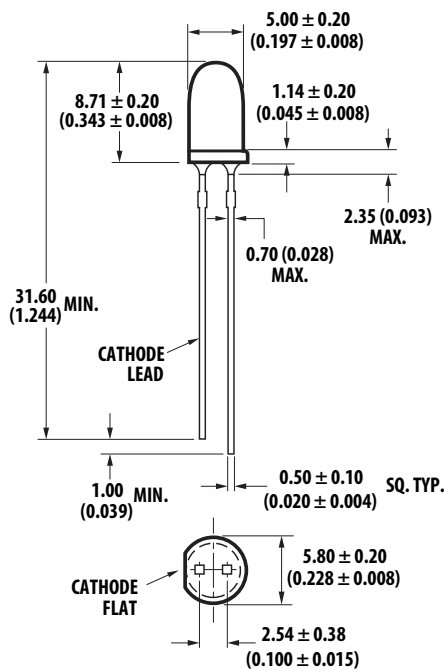

PACKAGE DIMENSION A

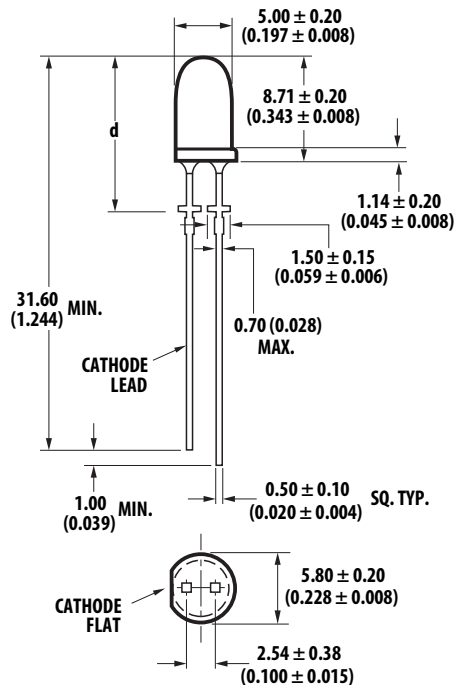

PACKAGE DIMENSION B

| HLMP-Cx14                          | HLMP-Cx25                           | HLMP-Cx35                           |
|------------------------------------|-------------------------------------|-------------------------------------|
| d = 12.6 ± 0.25<br>(0.496 ± 0.010) | d = 12.52 ± 0.25<br>(0.493 ± 0.010) | d = 11.96 ± 0.25<br>(0.471 ± 0.010) |

Notes:

1. Measured just above flange.
2. All dimensions are in millimeters (inches).
3. Epoxy meniscus may extend about 1mm (0.040") down the leads.

**Caution:** InGaN devices are Class 1C HBM ESD sensitive per JEDEC standard. Please observe appropriate precautions during handling and processing. Refer to Avago Application Note AN 1142 for details.

## Device Selection Guide

| Part Number     | Color | Typical Viewing Angle,<br>2 $\theta$ $\frac{1}{2}$ (Degree) | Intensity (mcd) at 20 mA |       | Leads with Stand-Offs |
|-----------------|-------|---|--------------------------|-------|-----------------------|
|                 |       |   | Min.                     | Max.  |                       |
| HLMP-CB13-UX0xx | Blue  | 15°   | 3200                     | 9300  | No                    |
| HLMP-CB14-UX0xx | Blue  | 15°   | 3200                     | 9300  | Yes                   |
| HLMP-CB22-SV0xx | Blue  | 23°   | 1900                     | 5500  | No                    |
| HLMP-CB25-SV0xx | Blue  | 23°   | 1900                     | 5500  | Yes                   |
| HLMP-CB34-RU0xx | Blue  | 30°   | 1500                     | 4200  | No                    |
| HLMP-CB35-RU0xx | Blue  | 30°   | 1500                     | 4200  | Yes                   |
| HLMP-CM13-Z30xx | Green | 15°   | 12000                    | 35000 | No                    |
| HLMP-CM14-Z30xx | Green | 15°   | 12000                    | 35000 | Yes                   |
| HLMP-CM22-X10xx | Green | 23°   | 7200                     | 21000 | No                    |
| HLMP-CM25-X10xx | Green | 23°   | 7200                     | 21000 | Yes                   |
| HLMP-CM34-X10xx | Green | 30°   | 7200                     | 21000 | No                    |
| HLMP-CM35-X10xx | Green | 30°   | 7200                     | 21000 | Yes                   |

### Notes:

1. Tolerance for luminous intensity measurement is  $\pm 15\%$
2. The optical axis is closely aligned with the package mechanical axis.
3. LED light output is bright enough to cause injuries to the eyes. Precautions must be taken to prevent looking directly at the LED without proper safety equipment.
4. 2 $\theta$  $\frac{1}{2}$  is the off-axis angle where the luminous intensity is  $\frac{1}{2}$  the on axis intensity.

## Part Numbering System

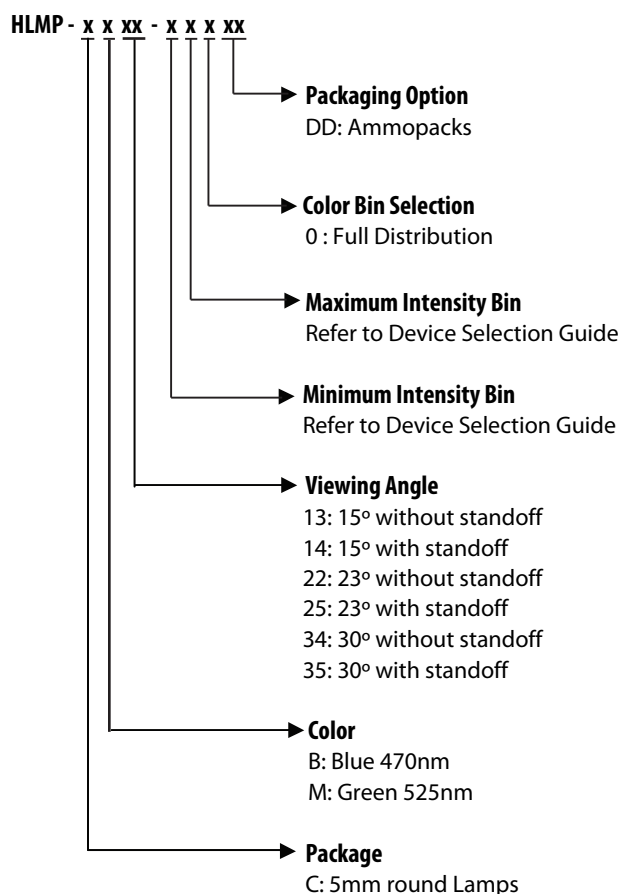

Note: Please refer to AB 5337 for complete information on part numbering system.

### Absolute Maximum Rating (T<sub>A</sub> = 25°C)

| Parameters                                 | Value       | Unit |
|--|-------------|------|
| DC forward current <sup>[1]</sup>          | 30          | mA   |
| Peak pulsed forward current <sup>[2]</sup> | 100         | mA   |
| Power dissipation                          | 116         | mW   |
| LED junction temperature                   | 110         | °C   |
| Operating temperature range                | -40 to +85  | °C   |
| Storage temperature range                  | -40 to +100 | °C   |

Notes:

1. Derate linearly as shown in figure 2.
2. Duty factor 10%, frequency 1KHz.

### Electrical/Optical Characteristics (T<sub>A</sub> = 25°C)

| Parameters                         | Symbol              | Blue and Green |      |     | Units | Test Condition  |
|------------------------------------|---------------------|----------------|------|-----|-------|---|
|                                    |                     | Min            | Typ  | Max |       |   |
| Forward Voltage                    | V <sub>F</sub>      | 2.8            | 3.2  | 3.8 | V     | I <sub>F</sub> = 20 mA  |
| Reverse Voltage <sup>[1]</sup>     | V <sub>R</sub>      | 5.0            |      |     | V     | I <sub>R</sub> = 10 μA  |
| Thermal resistance                 | R <sub>θJ-PIN</sub> |                | 240  |     | °C/W  | LED Junction to cathode lead  |
| Dominant wavelength <sup>[2]</sup> | λ <sub>d</sub>      |                |      |     | nm    | I <sub>F</sub> = 20 mA  |
| Blue                               |                     | 460            | 470  | 480 |       |   |
| Green                              |                     | 520            | 525  | 540 |       |   |
| Peak wavelength                    | λ <sub>PEAK</sub>   |                |      |     | nm    | Peak of wavelength of spectral distribution at I <sub>F</sub> = 20 mA               |
| Blue                               |                     |                | 464  |     |       |   |
| Green                              |                     |                | 516  |     |       |   |
| Spectral half width                | Δλ <sub>1/2</sub>   |                |      |     |       | Wavelength width at spectral distribution 1/2 power point at I <sub>F</sub> = 20 mA |
| Blue                               |                     |                | 22   |     |       |   |
| Green                              |                     |                | 35   |     |       |   |
| Luminous Efficacy <sup>[3]</sup>   | η <sub>v</sub>      |                |      |     | lm/W  | Emitted luminous power/Emitted radiant power  |
| Blue                               |                     |                | 78   |     |       |   |
| Green                              |                     |                | 545  |     |       |   |
| Luminous Flux                      | φ <sub>v</sub>      |                |      |     | lm    | I <sub>F</sub> = 20mA   |
| Blue                               |                     |                | 830  |     |       |   |
| Green                              |                     |                | 3500 |     |       |   |
| Luminous Efficiency <sup>[4]</sup> | η <sub>ε</sub>      |                |      |     | lm/W  | Luminous Flux/Electrical Power at I <sub>F</sub> = 20mA                             |
| Blue                               |                     |                | 13   |     |       |   |
| Green                              |                     |                | 56   |     |       |   |

Notes:

1. The reverse voltage of the product is equivalent to the forward voltage of the protective chip at I<sub>R</sub> = 10 μA
2. The dominant wavelength λ<sub>d</sub> is derived from the Chromaticity Diagram and represents the color of the lamp.
3. The radiant intensity, I<sub>e</sub> in watts/steradian, may be found from the equation I<sub>e</sub> = I<sub>v</sub>/η<sub>v</sub>, where I<sub>v</sub> is the luminous intensity in candelas and η<sub>v</sub> is the luminous efficacy in lumens/watt.
4. η<sub>ε</sub> = φ<sub>v</sub> / I<sub>F</sub> × V<sub>F</sub> where φ<sub>v</sub> is the emitted luminous flux, I<sub>F</sub> is electrical forward current and V<sub>F</sub> is the forward voltage.

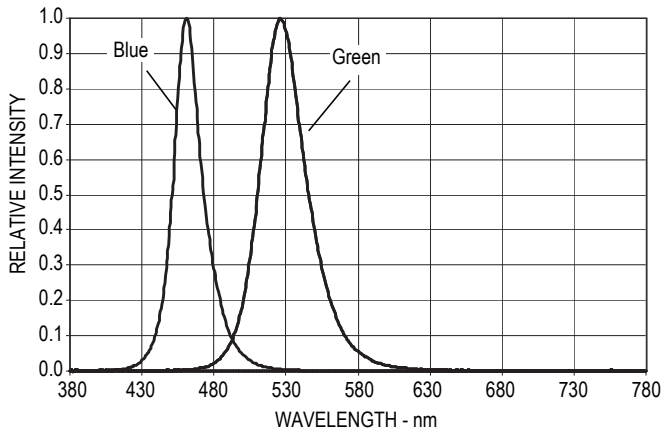

Figure 1. Relative Intensity vs. Wavelength

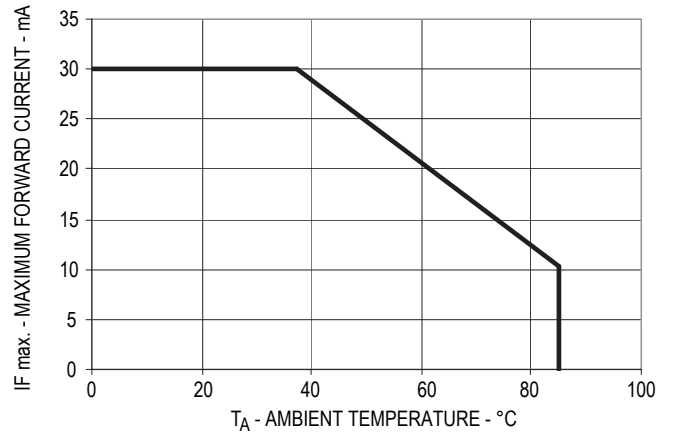

Figure 2. Forward Current vs. Ambient Temperature

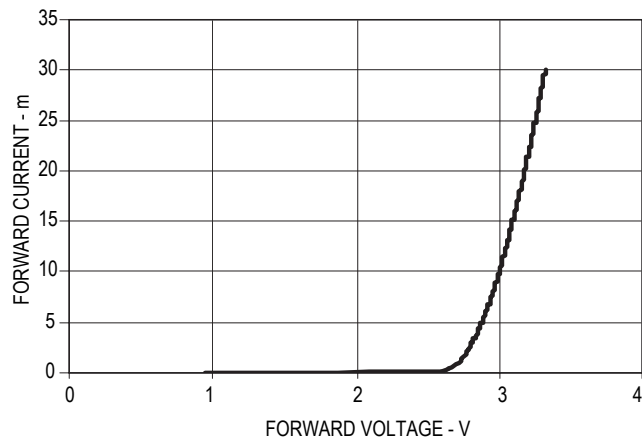

Figure 3. Forward Current vs. Forward Voltage

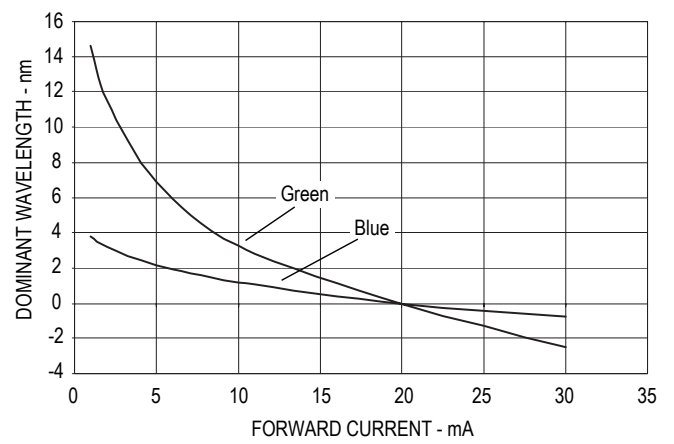

Figure 4. Relative Dominant Wavelength vs. DC Forward Current

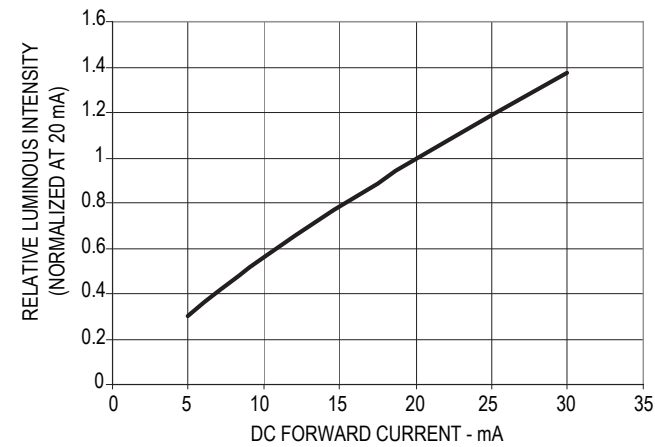
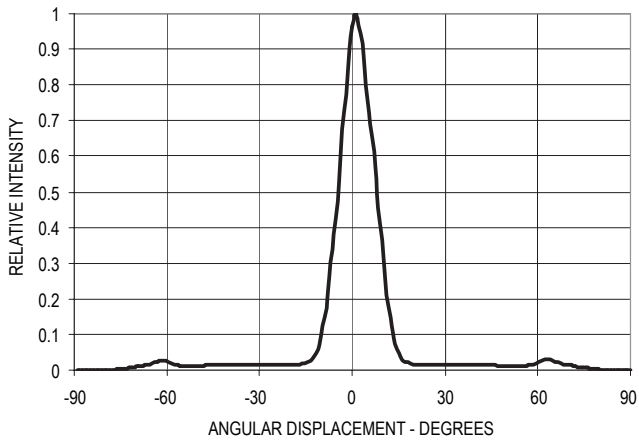
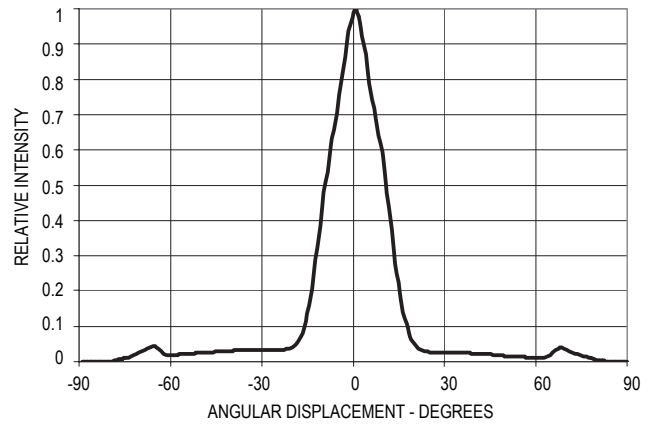

Figure 5. Relative Intensity vs. DC Forward Current



**Figure 6. Spatial Radiation Pattern for 15° lamps**



**Figure 7. Spatial Radiation Pattern for 23° lamps**

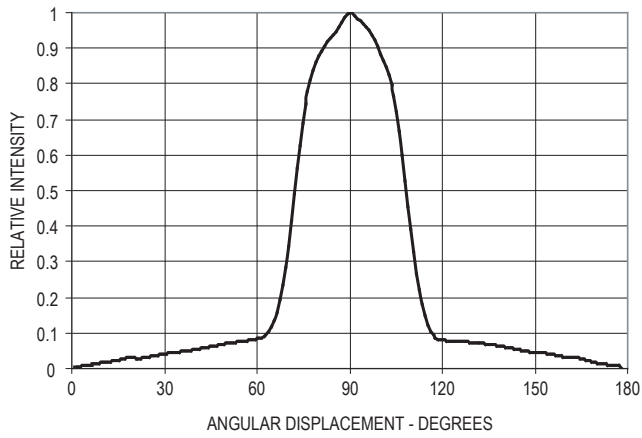

**Figure 8. Spatial Radiation Pattern for 30° lamps**

**Note:**

All bin categories are established for classification of products. Products may not be available in all bin categories. Please contact your Avago representative for further information

### Intensity Bin Limit Table

| Bin | Intensity (mcd) at 20 mA |       |
|-----|--------------------------|-------|
|     | Min                      | Max   |
| R   | 1500                     | 1900  |
| S   | 1900                     | 2500  |
| T   | 2500                     | 3200  |
| U   | 3200                     | 4200  |
| V   | 4200                     | 5500  |
| W   | 5500                     | 7200  |
| X   | 7200                     | 9300  |
| Y   | 9300                     | 12000 |
| Z   | 12000                    | 16000 |
| 1   | 16000                    | 21000 |
| 2   | 21000                    | 27000 |
| 3   | 27000                    | 35000 |

Tolerance for each bin limit is +/- 15%

### Green Color Bin Table

| Bin | Min Dom | Max Dom | Xmin   | Ymin   | Xmax   | Ymax   |
|-----|---------|---------|--------|--------|--------|--------|
| 1   | 520.0   | 524.0   | 0.0743 | 0.8338 | 0.1856 | 0.6556 |
|     |         |         | 0.1650 | 0.6586 | 0.1060 | 0.8292 |
| 2   | 524.0   | 528.0   | 0.1060 | 0.8292 | 0.2068 | 0.6463 |
|     |         |         | 0.1856 | 0.6556 | 0.1387 | 0.8148 |
| 3   | 528.0   | 532.0   | 0.1387 | 0.8148 | 0.2273 | 0.6344 |
|     |         |         | 0.2068 | 0.6463 | 0.1702 | 0.7965 |
| 4   | 532.0   | 536.0   | 0.1702 | 0.7965 | 0.2469 | 0.6213 |
|     |         |         | 0.2273 | 0.6344 | 0.2003 | 0.7764 |
| 5   | 536.0   | 540.0   | 0.2003 | 0.7764 | 0.2659 | 0.6070 |
|     |         |         | 0.2469 | 0.6213 | 0.2296 | 0.7543 |

Tolerance for each bin limit is  $\pm 0.5\text{nm}$

### Blue Color Bin Table

| Bin | Min Dom | Max Dom | Xmin   | Ymin   | Xmax   | Ymax   |
|-----|---------|---------|--------|--------|--------|--------|
| 1   | 460.0   | 464.0   | 0.1440 | 0.0297 | 0.1766 | 0.0966 |
|     |         |         | 0.1818 | 0.0904 | 0.1374 | 0.0374 |
| 2   | 464.0   | 468.0   | 0.1374 | 0.0374 | 0.1699 | 0.1062 |
|     |         |         | 0.1766 | 0.0966 | 0.1291 | 0.0495 |
| 3   | 468.0   | 472.0   | 0.1291 | 0.0495 | 0.1616 | 0.1209 |
|     |         |         | 0.1699 | 0.1062 | 0.1187 | 0.0671 |
| 4   | 472.0   | 476.0   | 0.1187 | 0.0671 | 0.1517 | 0.1423 |
|     |         |         | 0.1616 | 0.1209 | 0.1063 | 0.0945 |
| 5   | 476.0   | 480.0   | 0.1063 | 0.0945 | 0.1397 | 0.1728 |
|     |         |         | 0.1517 | 0.1423 | 0.0913 | 0.1327 |

Tolerance for each bin limit is  $\pm 0.5\text{nm}$

### Relative Light Output vs. Junction Temperature

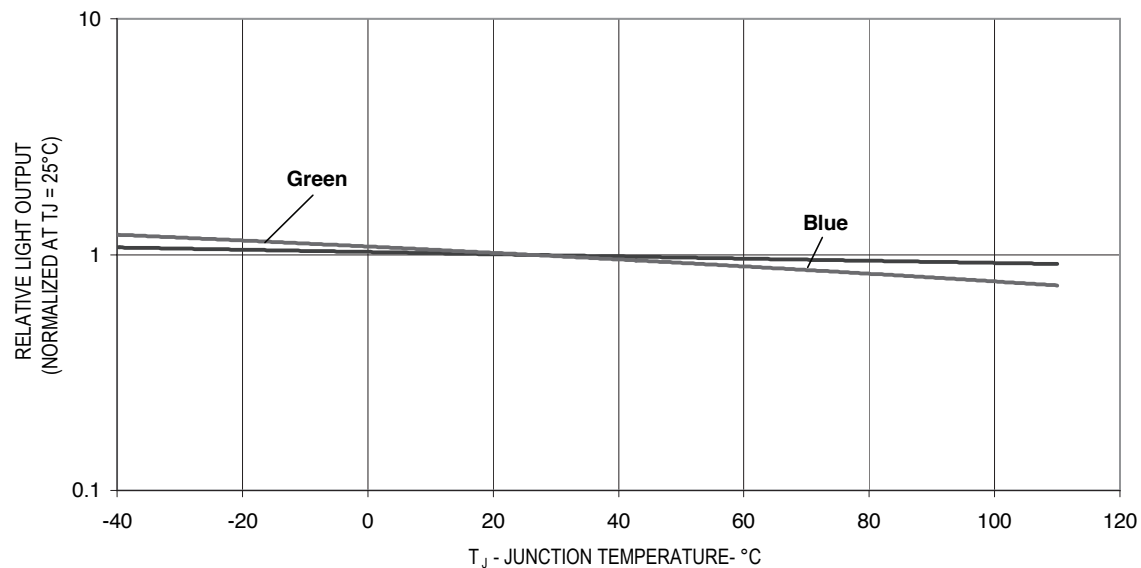

**Precautions:**

**Lead Forming:**

- The leads of an LED lamp may be preformed or cut to length prior to insertion and soldering on PC board.
- For better control, it is recommended to use proper tool to precisely form and cut the leads to applicable length rather than doing it manually.
- If manual lead cutting is necessary, cut the leads after the soldering process. The solder connection forms a mechanical ground which prevents mechanical stress due to lead cutting from traveling into LED package. This is highly recommended for hand solder operation, as the excess lead length also acts as small heat sink.

**Soldering and Handling:**

- Care must be taken during PCB assembly and soldering process to prevent damage to the LED component.
- LED component may be effectively hand soldered to PCB. However, it is only recommended under unavoidable circumstances such as rework. The closest manual soldering distance of the soldering heat source (soldering iron's tip) to the body is 1.59mm. Soldering the LED using soldering iron tip closer than 1.59mm might damage the LED.

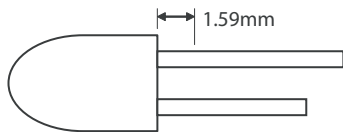

- ESD precaution must be properly applied on the soldering station and personnel to prevent ESD damage to the LED component that is ESD sensitive. Do refer to Avago application note AN 1142 for details. The soldering iron used should have grounded tip to ensure electrostatic charge is properly grounded.
- Recommended soldering condition:

|                      | Wave Soldering [1, 2] | Manual Solder Dipping |
|----------------------|-----------------------|-----------------------|
| Pre-heat temperature | 105 °C Max.           | -                     |
| Preheat time         | 60 sec Max            | -                     |
| Peak temperature     | 250 °C Max.           | 260 °C Max.           |
| Dwell time           | 3 sec Max.            | 5 sec Max             |

Note:

- 1) Above conditions refers to measurement with thermocouple mounted at the bottom of PCB.
  - 2) It is recommended to use only bottom preheaters in order to reduce thermal stress experienced by LED.
- Wave soldering parameters must be set and maintained according to the recommended temperature and dwell time. Customer is advised to perform daily check on the soldering profile to ensure that it is always conforming to recommended soldering conditions.

Note:

1. PCB with different size and design (component density) will have different heat mass (heat capacity). This might cause a change in temperature experienced by the board if same wave soldering setting is used. So, it is recommended to re-calibrate the soldering profile again before loading a new type of PCB.

**Avago Technologies LED configuration**

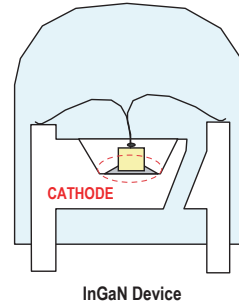

Note: Electrical connection between bottom surface of LED die and the lead frame is achieved through conductive paste.

- Any alignment fixture that is being applied during wave soldering should be loosely fitted and should not apply weight or force on LED. Non metal material is recommended as it will absorb less heat during wave soldering process.
- At elevated temperature, LED is more susceptible to mechanical stress. Therefore, PCB must allowed to cool down to room temperature prior to handling, which includes removal of alignment fixture or pallet.
- If PCB board contains both through hole (TH) LED and other surface mount components, it is recommended that surface mount components be soldered on the top side of the PCB. If surface mount need to be on the bottom side, these components should be soldered using reflow soldering prior to insertion the TH LED.
- Recommended PC board plated through holes (PTH) size for LED component leads.

| LED component lead size               | Diagonal                 | Plated through hole diameter             |
|---------------------------------------|--------------------------|--|
| 0.45 x 0.45 mm<br>(0.018x 0.018 inch) | 0.636 mm<br>(0.025 inch) | 0.98 to 1.08 mm<br>(0.039 to 0.043 inch) |
| 0.50 x 0.50 mm<br>(0.020x 0.020 inch) | 0.707 mm<br>(0.028 inch) | 1.05 to 1.15 mm<br>(0.041 to 0.045 inch) |

- Over-sizing the PTH can lead to twisted LED after clinching. On the other hand under sizing the PTH can cause difficulty inserting the TH LED.

Refer to Application Note 5334 for more information about soldering and handling of high brightness TH LED lamps.

### Example of Wave Soldering Temperature Profile for TH LED

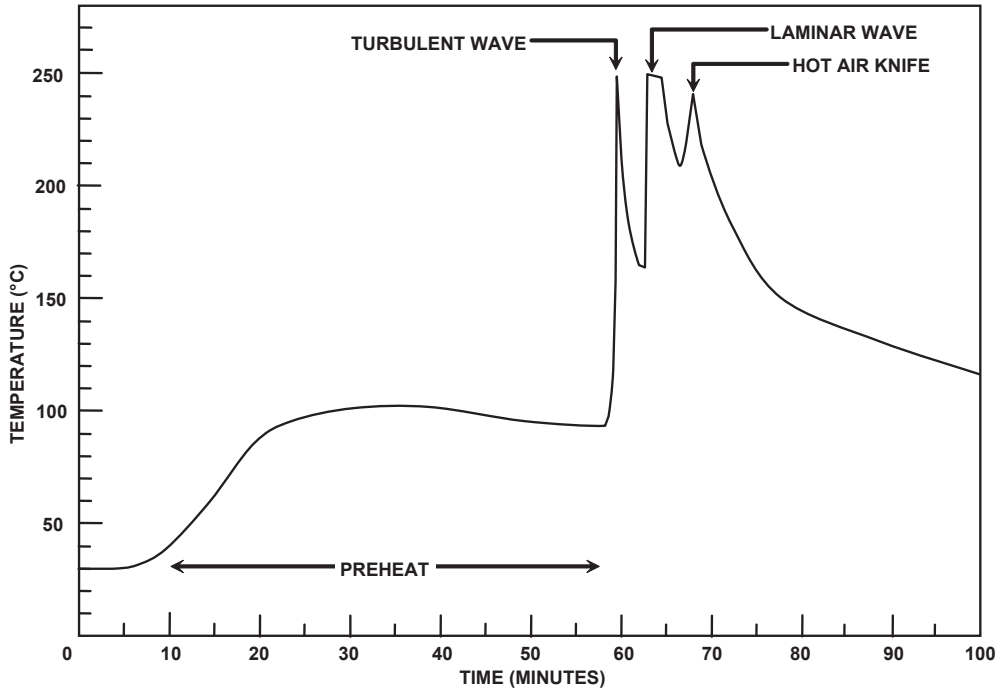

Recommended solder:  
 Sn63 (Leaded solder alloy)  
 SAC305 (Lead free solder alloy)

Flux: Rosin flux

Solder bath temperature:  
 245°C ± 5°C (maximum peak  
 temperature = 250°C)

Dwell time: 1.5 sec - 3.0 sec  
 (maximum = 3sec)

Note: Allow for board to be sufficiently  
 cooled to room temperature before  
 exerting mechanical force.

### Ammo Packs Drawing

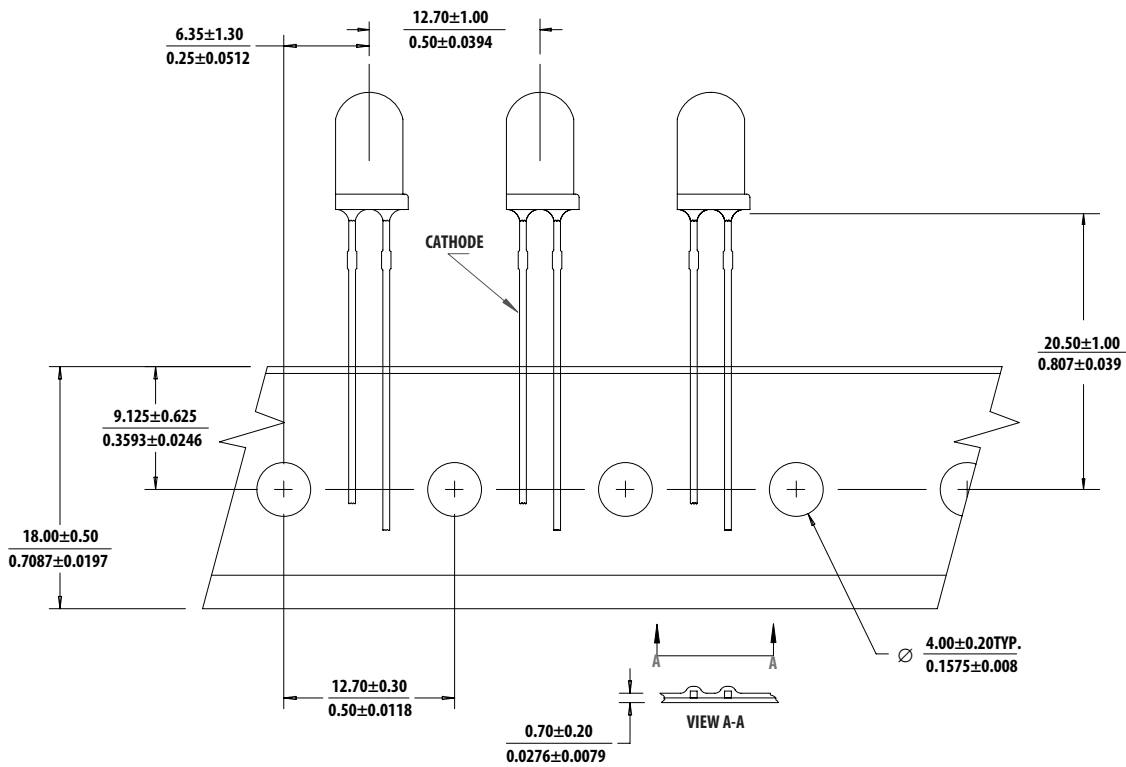

Note: The ammo-packs drawing is applicable for packaging option -DD & -ZZ and regardless standoff or non-standoff.



## Packaging Box for Ammo Packs

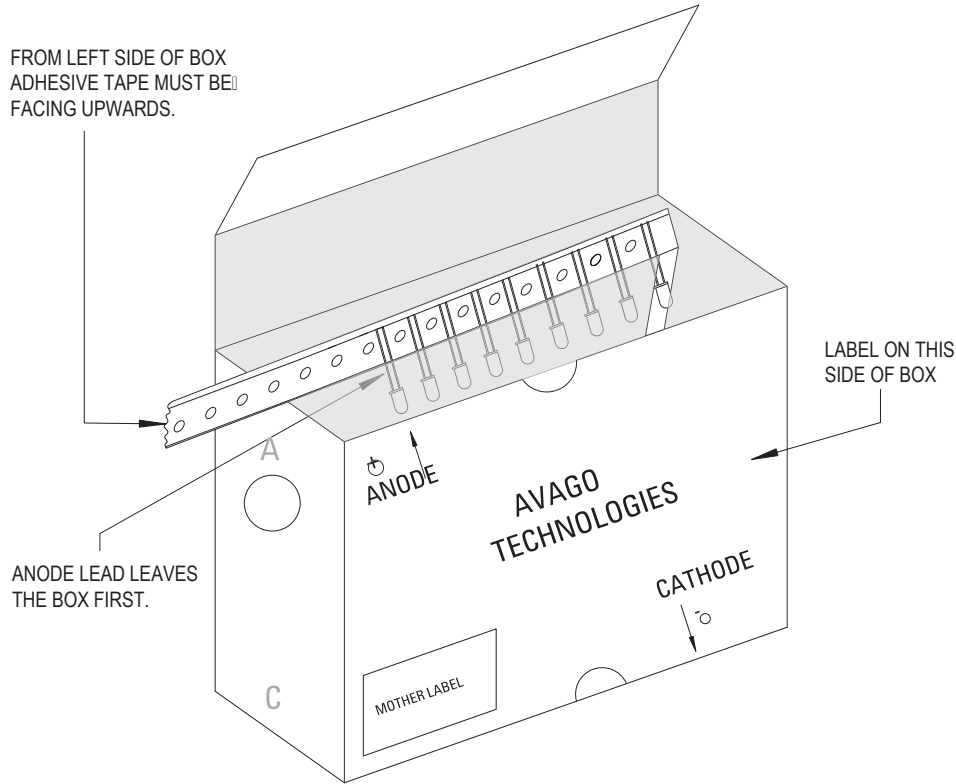











Note: For InGaN device, the ammo pack packaging box contain ESD logo

## Packaging Label

(i) Avago Mother Label: (Available on packaging box of ammo pack and shipping box)

|   |  |
|---|--|
| <b>AVAGO</b><br>TECHNOLOGIES            |  |
| STANDARD LABEL LS0002                   |  |
| RoHS Compliant                          |  |
| e3 max temp 250C                        |  |
| (1P) Item: <b>Part Number</b>           | (Q) QTY: <b>Quantity</b>               |
|   |  |
| (1T) Lot: <b>Lot Number</b>             | CAT: <b>Intensity Bin</b>              |
|   |  |
| LPN:                                    | BIN: <b>Refer to below information</b> |
|   |  |
| (9D)MFG Date: <b>Manufacturing Date</b> |  |
|   |  |
| <hr/>                                   |  |
| (P) Customer Item:                      | (9D) Date Code: <b>Date Code</b>       |
|   |  |
| (V) Vendor ID:                          | Made In: <b>Country of Origin</b>      |
|   |  |
| DeptID:                                 |  |
|   |  |

(ii) Avago Baby Label (Only available on bulk packaging)

|  |   |   |
|--|---|---|
| <br><b>Lamps Baby Label</b>                 |   | RoHS Compliant<br>e3 max temp 250C  |
| (1P) PART #: <b>Part Number</b><br>         |   |   |
| (1T) LOT #: <b>Lot Number</b><br>           |   |   |
| (9D)MFG DATE: <b>Manufacturing Date</b><br> | QUANTITY: <b>Packing Quantity</b><br>      |   |
| C/O: <b>Country of Origin</b>  |   |   |
| Customer P/N:<br>                           | CAT: <b>Intensity Bin</b><br>              |   |
| Supplier Code:<br>                          | BIN: <b>Refer to below information</b><br> |   |
|  |   | DATECODE: <b>Date Code</b><br> |

**Acronyms and Definition:**

BIN:

(i) Color bin only or VF bin only

(Applicable for part number with color bins but without VF bin OR part number with VF bins and no color bin)

OR

(ii) Color bin incorporated with VF Bin

(Applicable for part number that have both color bin and VF bin)

**Example:**

(i) Color bin only or VF bin only

BIN: 2 (represent color bin 2 only)

BIN: VB (represent VF bin "VB" only)

(ii) Color bin incorporate with VF Bin

BIN: 2VB

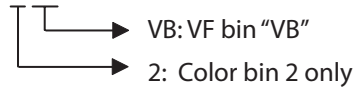

**DISCLAIMER:** AVAGO'S PRODUCTS AND SOFTWARE ARE NOT SPECIFICALLY DESIGNED, MANUFACTURED OR AUTHORIZED FOR SALE AS PARTS, COMPONENTS OR ASSEMBLIES FOR THE PLANNING, CONSTRUCTION, MAINTENANCE OR DIRECT OPERATION OF A NUCLEAR FACILITY OR FOR USE IN MEDICAL DEVICES OR APPLICATIONS. CUSTOMER IS SOLELY RESPONSIBLE, AND WAIVES ALL RIGHTS TO MAKE CLAIMS AGAINST AVAGO OR ITS SUPPLIERS, FOR ALL LOSS, DAMAGE, EXPENSE OR LIABILITY IN CONNECTION WITH SUCH USE.

For product information and a complete list of distributors, please go to our web site: [www.avagotech.com](http://www.avagotech.com)

Avago, Avago Technologies, and the A logo are trademarks of Avago Technologies in the United States and other countries. Data subject to change. Copyright © 2005-2009 Avago Technologies. All rights reserved. AV02-0678EN - January 15, 2009

