

455870003
FIRST GENERATION POLARIZATION

NOTES:

- 1) MATERIAL:
HOUSING: NYLON, UL94V-0, COLOR: BLACK
- 2) FINISH: NONE
- 3) PRODUCT SPECIFICATION: PS-45558-001
- 4) PACKAGING: PER PK-5557-002
- 5) 455870003 RECEPTACLE HOUSING MATES WITH 455860001 AND 455860004 HEADER ASSEMBLIES; 455870002 RECEPTACLE HOUSING MATES WITH 455860002 HEADER ASSEMBLY. 455870004 RECEPTACLE HOUSING MATES WITH 455860005 HEADER ASSEMBLY.
- 6) PART TO BE USED WITH MOLEX FEMALE TERMINAL SERIES 5556.
- 7) ALL DIMENSIONS ARE REFERENCE UNLESS OTHERWISE SPECIFIED WITH A TOLERANCE.
- 8) PART IS NOT DESIGNED FOR CURRENT SHARING.
- 9) PARTS ARE NOT TO BE MATED OR UNMATED WHILE CIRCUITS ARE LIVE.
- 10) RIB INDICATES CIRCUIT NUMBER 1.
- 11) PART CONFORMS TO CLASS "B" REQUIREMENTS OF COSMETIC SPECIFICATION PS-45499-002.
- 12) WIRES ARE TO BE DRESSED IN SUCH A MANNER TO ALLOW THE TERMINALS TO FLOAT FREELY IN THE POCKET

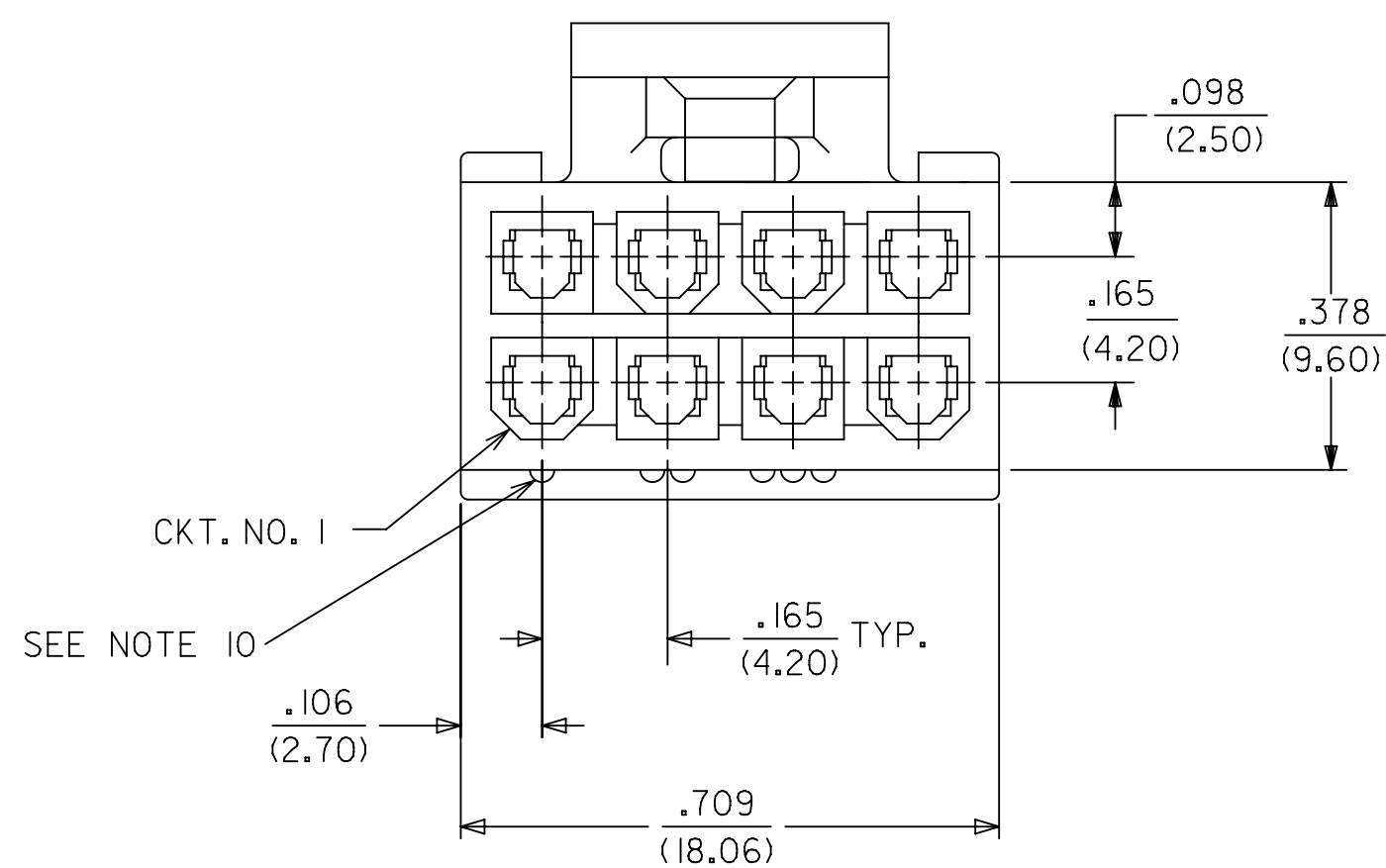

CIRCUIT SIZE	PART NUMBER	POLARIZATION TYPE
8	455870003	FIRST GENERATION
	455870002	SECOND GENERATION
	455870004	THIRD GENERATION

THIS DRAWING CONTAINS INFORMATION THAT IS PROPRIETARY TO MOLEX ELECTRONIC TECHNOLOGIES, LLC AND SHOULD NOT BE USED WITHOUT WRITTEN PERMISSION													
DIMENSION UNITS		SCALE		CURRENT REV DESC:				molex					
mm		NTS		EC NO: 726879				8 CKT. RECEPT. HOUSING SPECIAL POLARIZATION MINI-FIT JR. SERIES					
GENERAL TOLERANCES (UNLESS SPECIFIED)		DRWN: JERRYW8 2022/11/02											
4 PLACES	±	MM	INCH	CHK'D: XQZHANG 2022/11/07				PRODUCT CUSTOMER DRAWING					
3 PLACES	±	±	±	APPR: XQZHANG 2022/11/07				DOCUMENT NUMBER					
2 PLACES	±	0.25	± 0.015	INITIAL REVISION:				SD-45587-001		DOC TYPE		DOC PART	
1 PLACE	±	0.38	±	DRWN: CLS 2003/07/15				PSD		001		D	
0 PLACES	±	±	±	APPR: FSMITH 2011/03/01				MATERIAL NUMBER		CUSTOMER		SHEET NUMBER	
ANGULAR TOL ± 5.0 °				THIRD ANGLE PROJECTION		DRAWING		SERIES		GENERAL MARKET		1 OF 2	
DRAFT WHERE APPLICABLE MUST REMAIN WITHIN DIMENSIONS				C-SIZE		45587		SEE TABLE		GENERAL MARKET		1 OF 2	

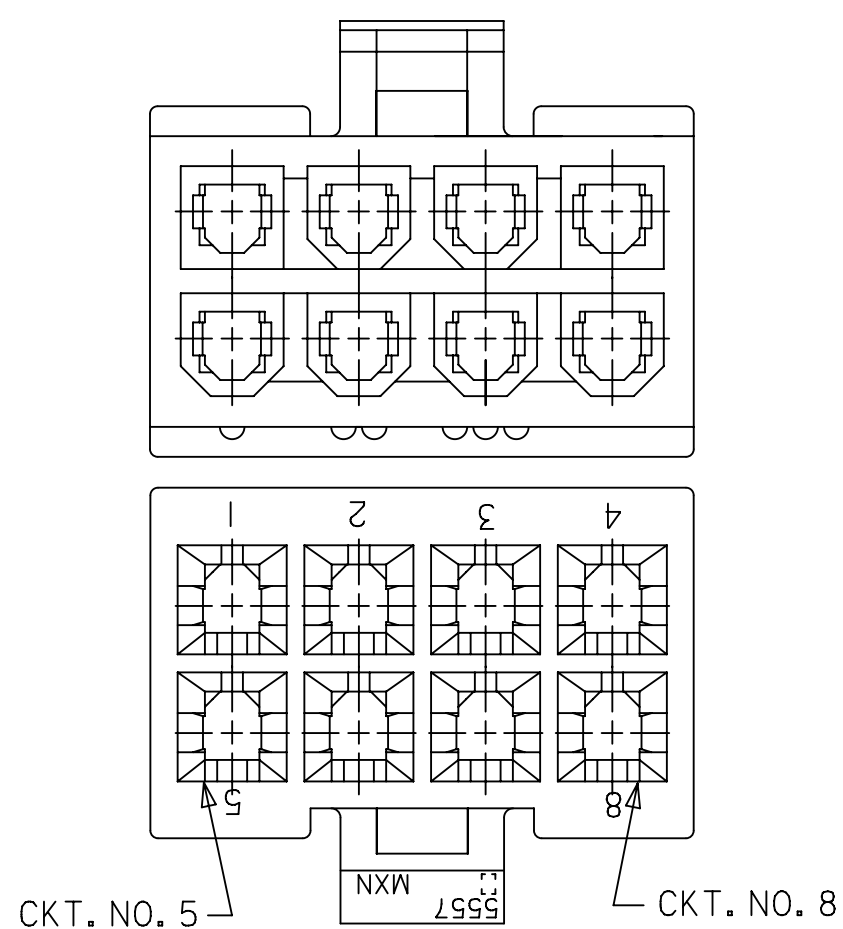

455870002
SECOND GENERATION POLARIZATION

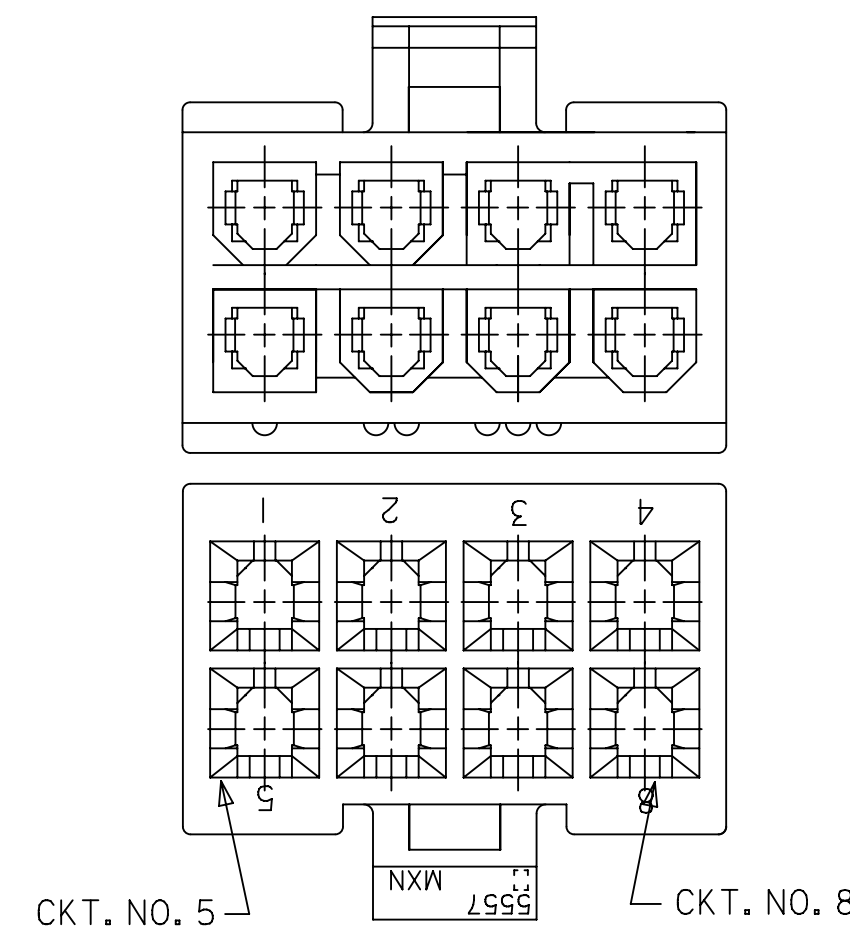

455870004
THIRD GENERATION POLARIZATION

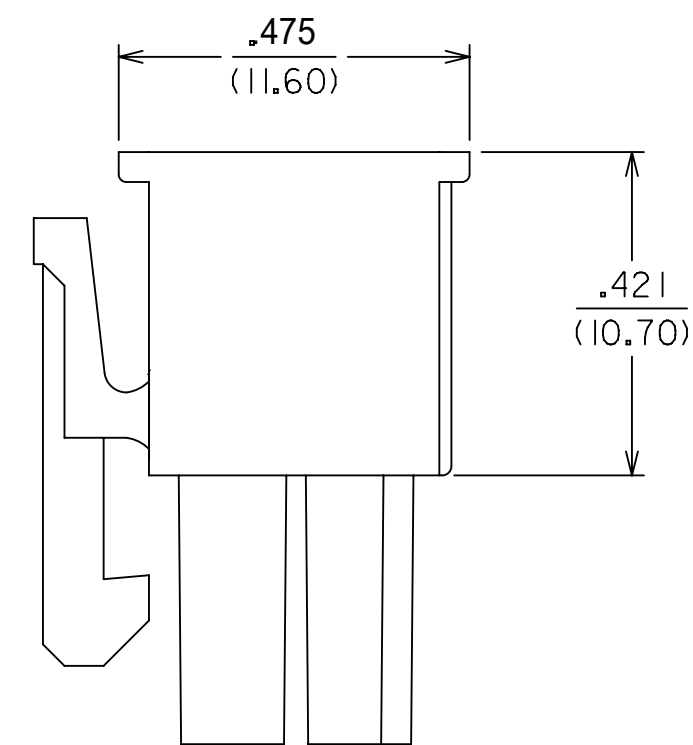
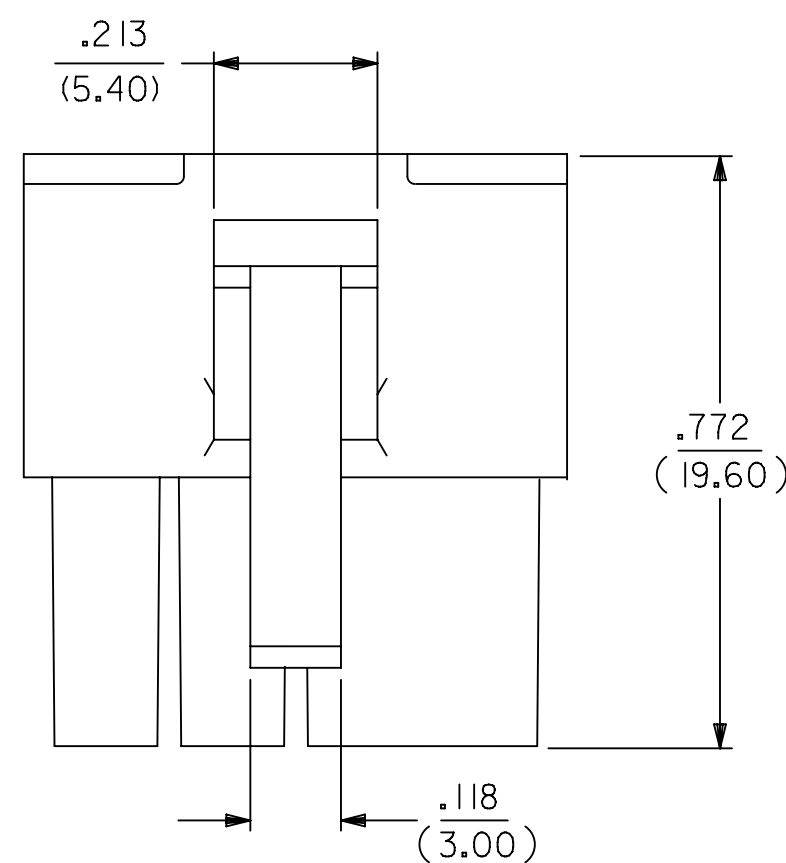
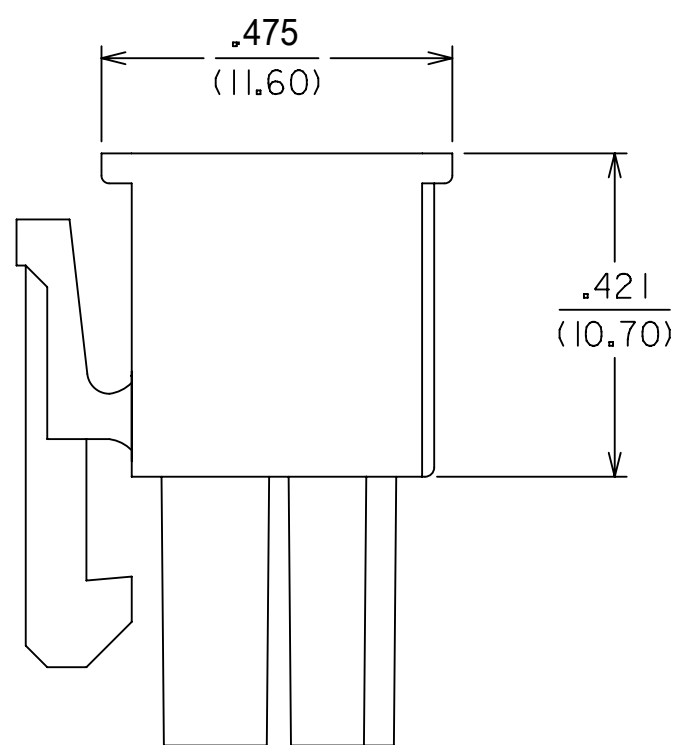
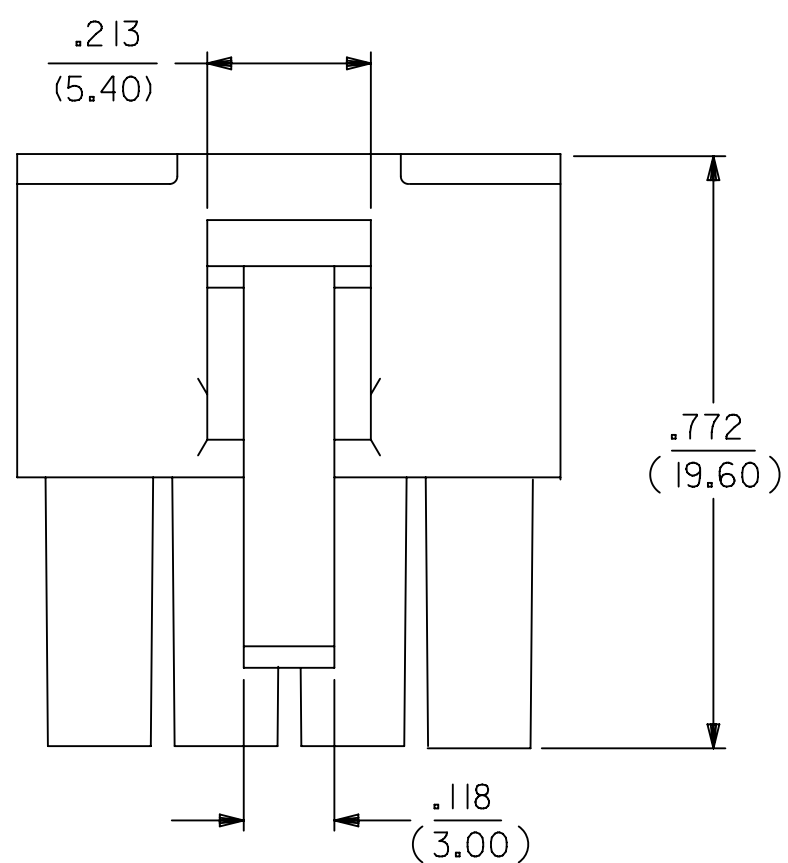

THIS DRAWING CONTAINS INFORMATION THAT IS PROPRIETARY TO MOLEX ELECTRONIC TECHNOLOGIES, LLC AND SHOULD NOT BE USED WITHOUT WRITTEN PERMISSION									
DIMENSION UNITS		SCALE		CURRENT REV DESC:				molex	
mm		NTS							
GENERAL TOLERANCES (UNLESS SPECIFIED)				EC NO: 726879		2022/11/02		8 CKT. RECEPT. HOUSING SPECIAL POLARIZATION MINI-FIT JR. SERIES	
4 PLACES		±		DRWN: JERRYW8		2022/11/07			
3 PLACES		±		CHK'D: XQZHANG		2022/11/07		PRODUCT CUSTOMER DRAWING	
2 PLACES		± 0.25		APPR: XQZHANG		2022/11/07			
1 PLACE		± 0.38		INITIAL REVISION:				DOCUMENT NUMBER	
0 PLACES		±		DRWN: CLS		2003/07/15			
ANGULAR TOL		± 5.0 °		APPR: FSMITH		2011/03/01		DOC TYPE	
DRAFT WHERE APPLICABLE MUST REMAIN WITHIN DIMENSIONS				THIRD ANGLE PROJECTION		DRAWING		DOC PART	
				C-SIZE		SERIES		REVISION	
						45587		1	
						SEE TABLE		GENERAL MARKET	
						SHEET NUMBER		2 OF 2	