

# GSEP12U005

## Low Capacitance TVS Diode Array

### Features

- Low capacitance
- Ultra-low leakage: nA level
- Low operating voltage: 5V
- Low clamping voltage
- Protection up to 3 data lines and 1 power line
- Complies with following standards:
  - IEC 61000-4-2 (ESD) immunity test
  - Air discharge:  $\pm 25\text{kV}$
  - Contact discharge:  $\pm 20\text{kV}$

### Applications

- USB2.0
- USB OTG

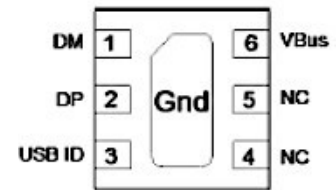

DFN1616

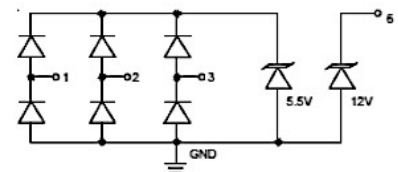

Schematic Diagram

### Absolute Maximum Ratings ( $T_A=25^\circ\text{C}$ unless otherwise specified)

Parameter	Symbol	Value	Unit
<b>DP, DM, USB ID(Pins 1, 2, 3)</b>			
Peak Pulse Power (8/20 $\mu\text{s}$ )	$P_{PK}$	100	W
Peak Pulse Current (8/20 $\mu\text{s}$ )	$I_{PP}$	5	A
ESD per IEC 61000-4-2 (Air)	$V_{ESD}$	$\pm 25$	kV
ESD per IEC 61000-4-2 (Contact)		$\pm 20$	
Operating Temperature Range	$T_J$	-55 To +150	$^\circ\text{C}$
Storage Temperature Range	$T_{STG}$	-55 To +150	$^\circ\text{C}$
<b>VBus (Pin 6)</b>			
Peak Pulse Power (8/20 $\mu\text{s}$ )	$P_{PK}$	300	W
Peak Pulse Current (8/20 $\mu\text{s}$ )	$I_{PP}$	12	A
ESD per IEC 61000-4-2 (Air)	$V_{ESD}$	$\pm 25$	kV
ESD per IEC 61000-4-2 (Contact)		$\pm 20$	
Operating Temperature Range	$T_J$	-55 To +150	$^\circ\text{C}$
Storage Temperature Range	$T_{STG}$	-55 To +150	$^\circ\text{C}$

**GSEP12U005**  
**Low Capacitance TVS Diode Array**

**Electrical Characteristics** ( $T_A=25^{\circ}\text{C}$  unless otherwise specified)

Parameter	Symbol	Conditions	Min.	Max.	Unit
<b>DP, DM, USB ID TVS</b>					
Reverse Working Voltage	$V_{RWM}$	Any I/O to Ground	-	5.5	V
Breakdown Voltage	$V_{BR}$	$I_T=1\text{mA}$ , Any I/O to Ground	6.5	8.6	V
Reverse Leakage Current	$I_R$	$V_{RWM}=5.5\text{V}$ , Any I/O to Ground	-	0.5	$\mu\text{A}$
Clamping Voltage	$V_C$	$I_{PP}=1\text{A}$ (8/20 $\mu\text{S}$ pulse), Any I/O Pin to Ground	-	10	V
Clamping Voltage		$I_{PP}=5\text{A}$ (8/20 $\mu\text{S}$ pulse), Any I/O Pin to Ground	-	20	V
Junction Capacitance	$C_J$	$V_R=0\text{V}$ , $f=1\text{MHz}$ , Between I/O pins	-	0.5	pF
Junction Capacitance		$V_R=0\text{V}$ , $f=1\text{MHz}$ , Any I/O Pin to Ground	-	0.8	pF
<b>VBus TVS</b>					
Reverse Working Voltage	$V_{RWM}$	Pin 6 to Ground	-	12	V
Breakdown Voltage	$V_{BR}$	$I_T=1\text{mA}$ , Pin6 to Ground	12.5	15.8	V
Reverse Leakage Current	$I_R$	$V_{RWM}=12\text{V}$ , Pin6 to Ground	-	0.1	$\mu\text{A}$
Clamping Voltage	$V_C$	$I_{PP}=1\text{A}$ (8/20 $\mu\text{S}$ pulse), Pin6 to Ground	-	18	V
Clamping Voltage		$I_{PP}=12\text{A}$ (8/20 $\mu\text{S}$ pulse), Pin6 to Ground	-	25	V
Junction Capacitance	$C_J$	$V_R=0\text{V}$ , $f=1\text{MHz}$ , Pin6 to Ground	-	100	pF

**Note:** I/O Pins are 1, 2, 3

**Typical Performance Characteristics** ( $T_A=25^{\circ}\text{C}$  unless otherwise specified)

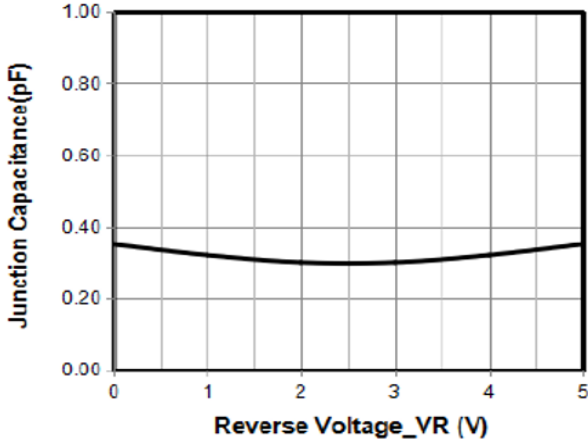

Figure 1. Junction Capacitance vs Reverse Voltage

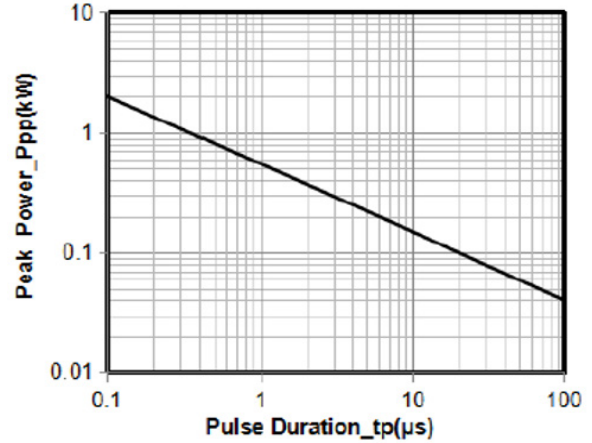

Figure 2. Peak Pulse Power vs Pulse Time

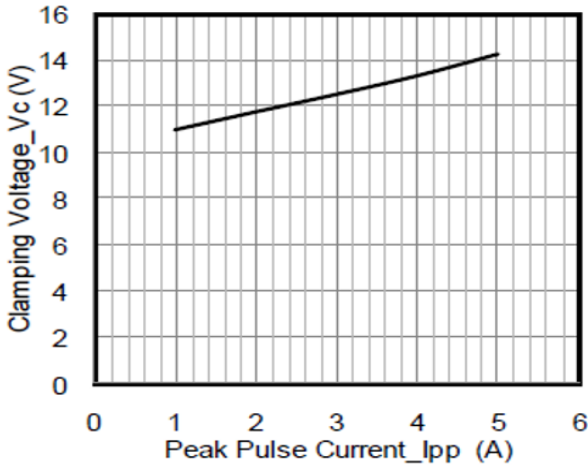

Figure 3. Clamping Voltage vs Peak Pulse Current

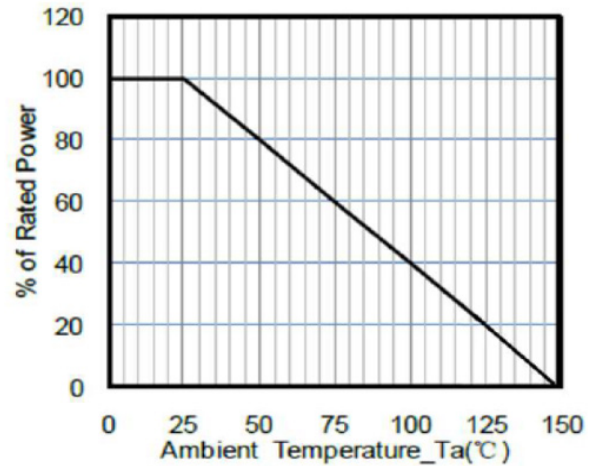

Figure 4. Ambient Temperature vs. % of Rated Power

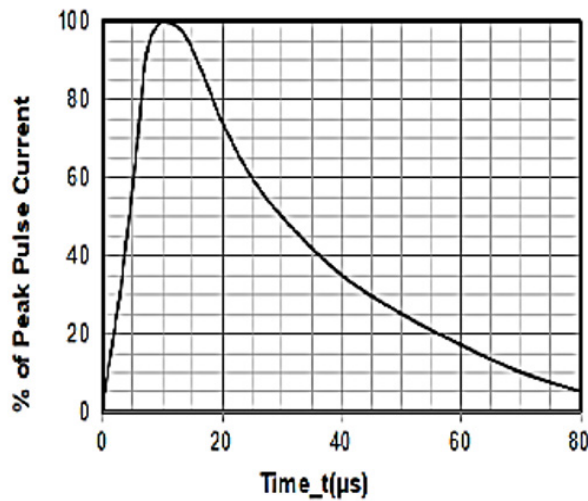
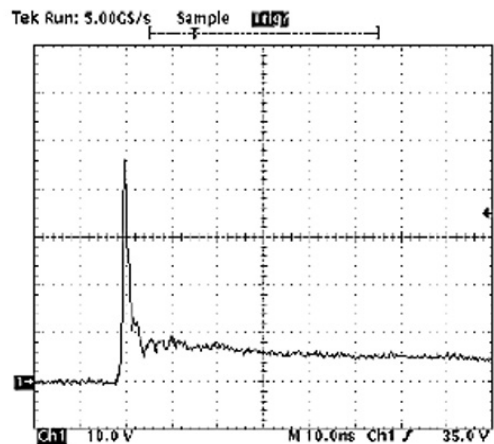
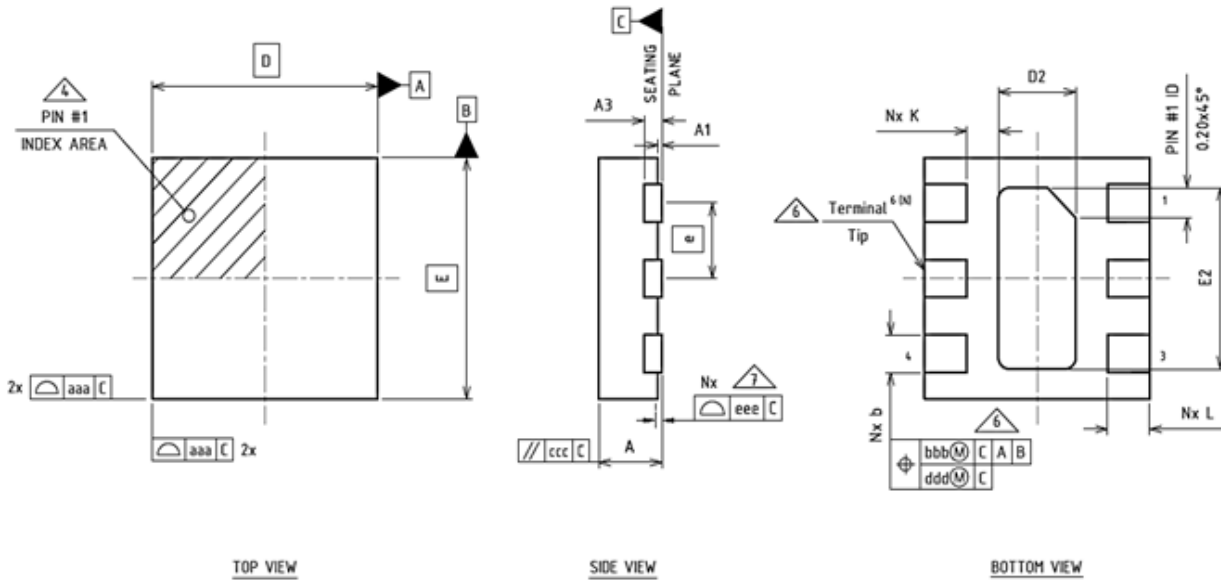

Figure 5. 8x20us Pulse Waveform



Note: Data is taken with a 10x attenuator  
 Figure 6. ESD Clamping Voltage 8kV Contact per IEC61000-4-2

**Package Outline Dimensions (DFN1616)**



**Dimension in millimeters**

Symbols	Min.	Nom.	Max.
A	0.45	0.50	0.55
A1	0.00	0.02	0.05
A3	0.127 Ref		
b	0.18	0.25	0.30
D	1.60 BSC		
E	1.60 BSC		
e	0.50 BSC		
D2	0.40	0.55	0.65
E2	1.05	1.20	1.30
K	0.15		
L	0.20	0.30	0.40
aaa	0.05		
bbb	0.10		
ccc	0.10		
ddd	0.05		
eee	0.08		

**Dimension in inches**

Symbols	Min.	Nom.	Max.
A	0.018	0.020	0.022
A1	0.000	0.001	0.002
A3	0.005 Ref		
b	0.007	0.010	0.012
D	0.063 BSC		
E	0.063BSC		
e	0.020 BSC		
D2	0.016	0.022	0.026
E2	0.041	0.047	0.051
K	0.006		
L	0.008	0.012	0.016
aaa	0.002		
bbb	0.004		
ccc	0.004		
ddd	0.002		
eee	0.003		

**NOTE:**

1. Dimensioning and tolerancing conform to ASME Y14.5-2009.
2. All dimensions are in millimeters.
3. N is the total number of terminals.

4. The location of marked terminal #1 identifier is within the hatched area.

5. NE refers to the maximum number of terminals on E side.

6. Dimension b applies to the metalized terminal and is measured between 0.15mm and 0.30mm from the terminal tip. If the terminal has a radius on the other end of it, dimension b should not be measured in that radius area.

7. Coplanarity applies to the terminals and all other bottom surface metalization.

**Recommended Pad Layout**

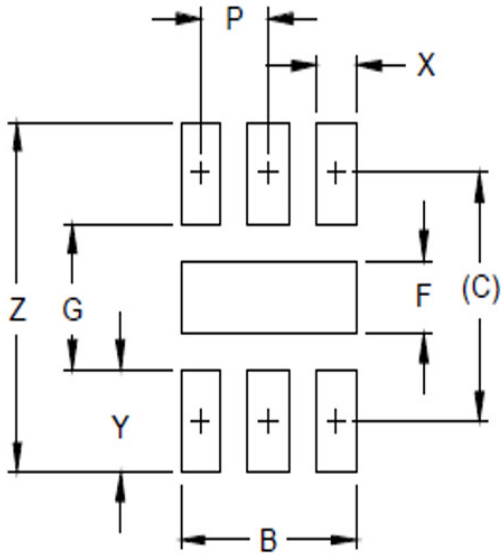

DIMENSIONS		
DIM	INCHES	MILLIMETERS
B	.051	1.30
C	.060	1.52
P	.020	0.50
F	.018	0.45
G	.035	0.89
X	.012	0.30
Y	.025	0.63
Z	.085	2.15

**Order Information**

Device	Package	Marking	Carrier	Quantity	HSF Status
GSEP12U005	DFN1616	1203	Tape & Reel	5,000 pcs / Reel	RoHS Compliant