

REVISIONS					
REV	ECO	DESCRIPTION	DATE	BY	APPR
A3	-	RELEASE NEW DRAWING FORMAT	11DEC13	DRP	-

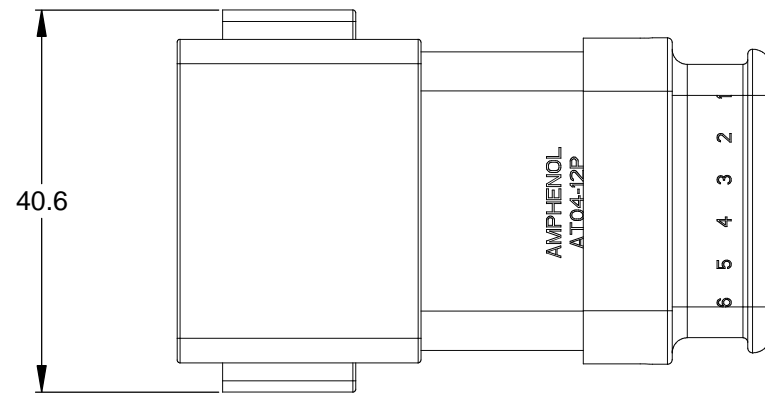

REQUIRES CONTACT RETENTION WEDGE AW12P

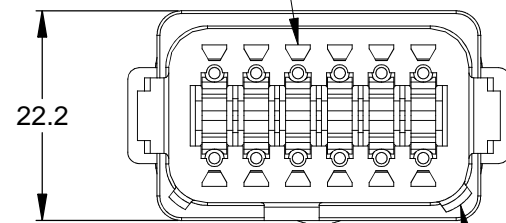

1 KEYWAY (3) PLACES

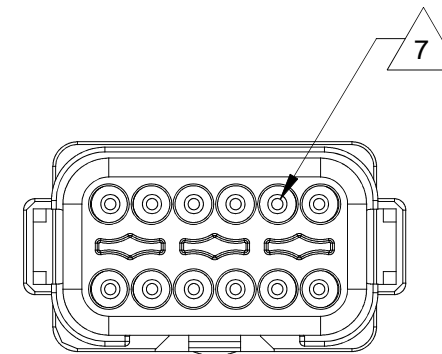
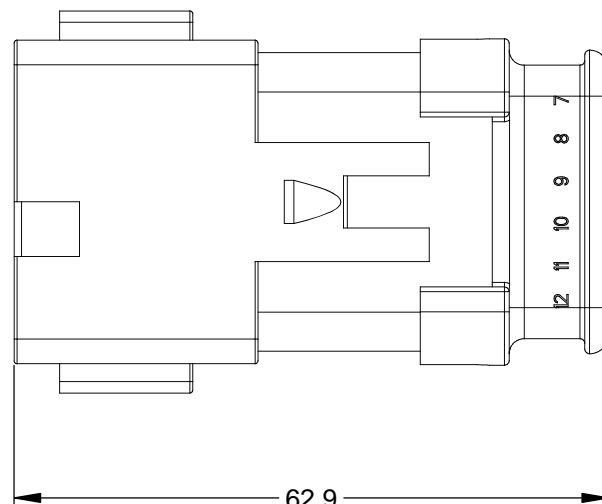
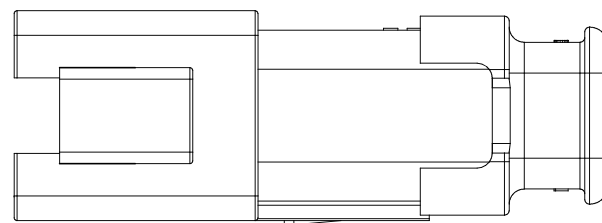

STRAIN RELIEF END CAP - BLACK - ALL CONNECTORS

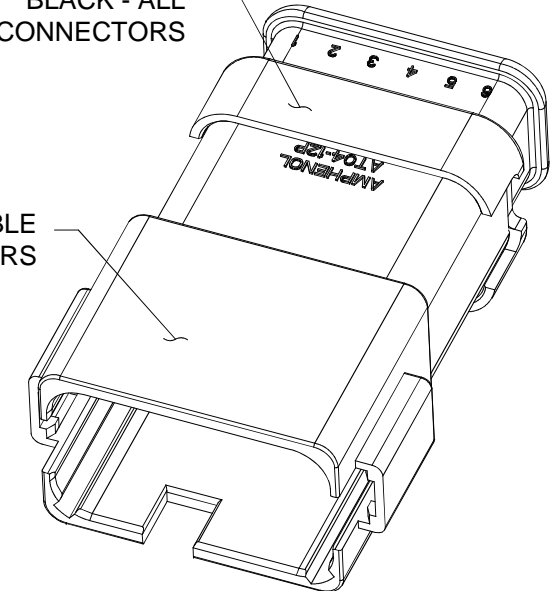

1 REFER TO SHEET 2 FOR AVAILABLE CONNECTOR HOUSING COLORS

NOTES: UNLESS OTHERWISE SPECIFIED

1 SEE SHEET 2 FOR KEY ARRANGEMENTS AND COLORS.

2. MATERIAL:
HOUSING: THERMOPLASTIC
SEAL: SILICONE RUBBER

3. MODIFICATIONS: STRAIN RELIEF END CAP

4. SPECIFICATIONS:
4.1 CURRENT RATING: 13 AMPS
4.2 OPERATING TEMPERATURE: -55°C TO +125°C
4.3 DIELECTRIC WITHSTANDING VOLTAGE: LESS THAN 2 MILLIAMPS CURRENT LEAKAGE @ 1500 VOLTS AC.
4.4 INSULATION RESISTANCE: 1000 MEGOHMS MIN @ 25°C.
4.5 MOISTURE RESISTANCE: IP67 (MATED CONDITION)
4.6 MATING CYCLE DURABILITY: 100 CYCLES
4.7 RoHS COMPLIANT

5. MATING PART: AT06-12SX* PLUG
(X = A,B,C,D KEYS; * = MODIFICATIONS AND COLORS)

6. ALL DIMENSIONS ARE FOR REFERENCE USE ONLY.

7 CONTACT SIZE AND REAR SEAL WIRE RANGE:

CONTACT SIZE	MIN. INSUL O.D.	MAX. INSUL O.D.	TYPICAL WIRE RANGE
16	2.24 mm (.088 in)	3.68 mm (.145 in)	14 - 20 AWG

TITLE: RECEPTACLE, 12 PIN, AT SERIES, KEYED, STRAIN RELIEF END CAP

DWG NO.: AT04-12PX-SRXXX

REV: A3

SH: 1

OF: 2

QUANTITY	SEE SHEET 2 PART NUMBER	DESCRIPTION	ITEM
MATERIALS LIST			
UNLESS OTHERWISE SPECIFIED 1) All dimensions are in metric (mm). 2) Tolerances are as follows: 1 PL DEC ±0.30 2 PL DEC ±0.15 3 PL DEC ±0.08 Fractions ±1/64 Angles ±1° 3) Note reference = X		SIGNATURES DRAWN: D.PARKS CHECKED: ENGINEER: APPROVAL:	DATE 11DEC13
MATERIAL SPECIFICATIONS:		<h1>Amphenol</h1> <p>Sine Systems - www.amphenol-sine.com 44724 Morley Drive Clinton Township, MI 48036</p>	
PROCESS SPECIFICATIONS:			
NEXT ASSY:		CUSTOMER: THIS DRAWING IS SUPPLIED FOR INFORMATION ONLY. DESIGN FEATURES, SPECIFICATIONS AND PERFORMANCE DATA SHOWN HEREON ARE THE PROPERTY OF THE AMPHENOL CORPORATION. NO RIGHTS OF REPRODUCTION ARE IMPLIED. ALL DIMENSIONS ARE SUBJECT TO NORMAL MANUFACTURING VARIATIONS.	<p>RECEPTACLE, 12 PIN, AT SERIES, KEYED, STRAIN RELIEF END CAP</p>
SIZE	TYPE	DWG NO.	REVISION
B	C-	AT04-12PX-SRXXX	A3
SCALE:	NONE	SHEET 1 OF 2	

REVISIONS					
REV	ECO	DESCRIPTION	DATE	BY	APPR

P/N AT04-12PA-SRGRY
KEY-A CONFIGURATION
STANDARD COLOR: GREY

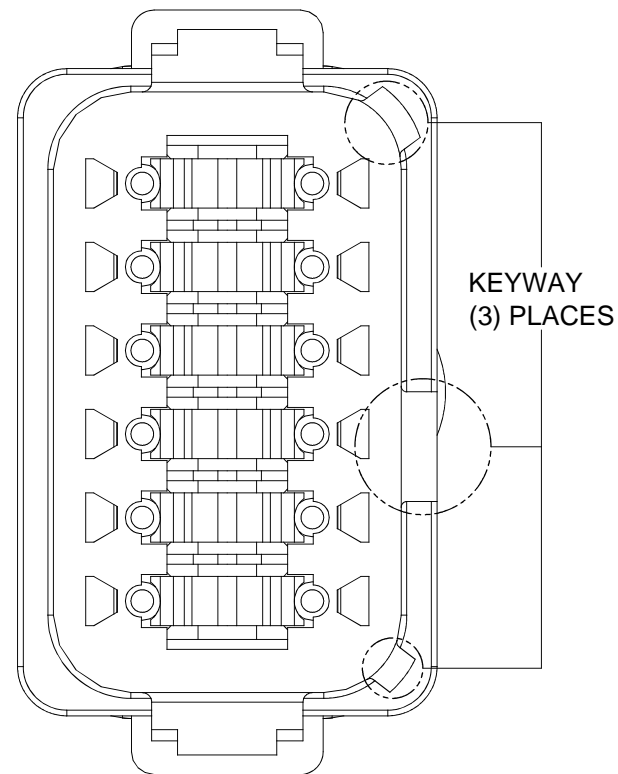

P/N AT04-12PB-SRBK
KEY-B CONFIGURATION
STANDARD COLOR: BLACK

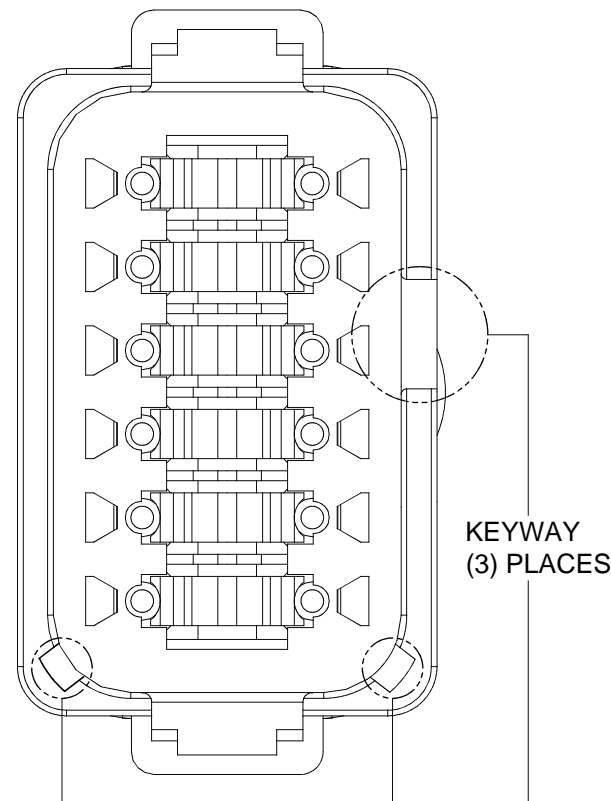

P/N AT04-12PC-SRGN
KEY-C CONFIGURATION
STANDARD COLOR: GREEN

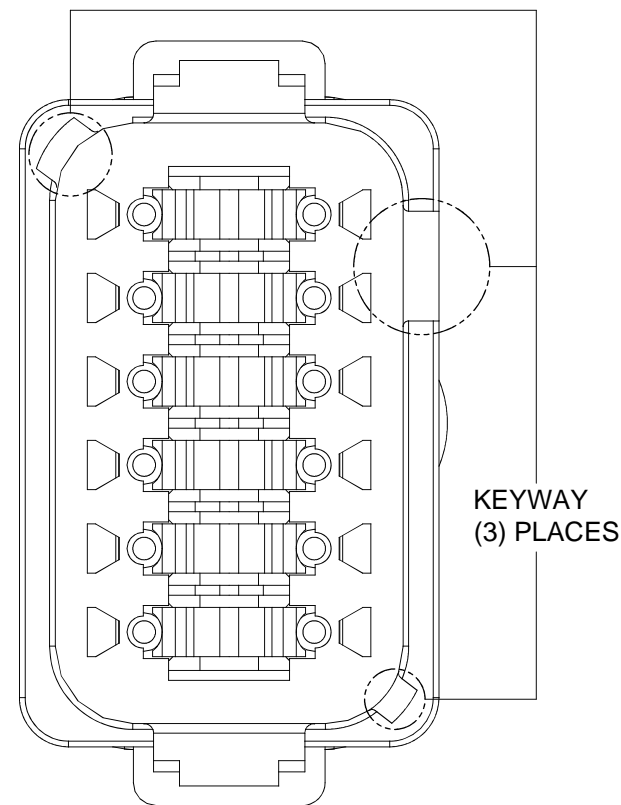

P/N AT04-12PD-SRBR
KEY-D CONFIGURATION
STANDARD COLOR: BROWN

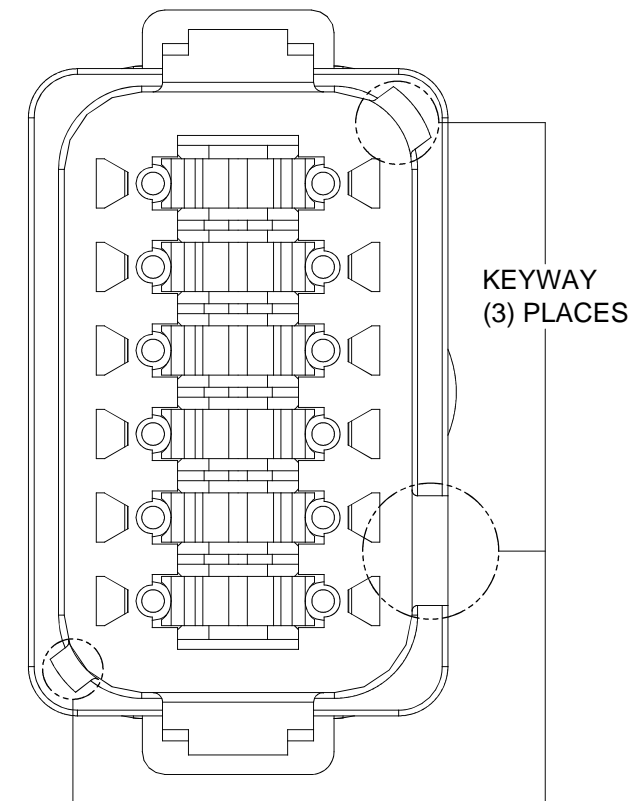

KEY-A CONFIGURATION	
COLOR	PART NUMBER
* GREY	AT04-12PA-SRGRY
BLACK	AT04-12PA-SRBK
GREEN	AT04-12PA-SRGN
BROWN	AT04-12PA-SRBR

KEY-B CONFIGURATION	
COLOR	PART NUMBER
GREY	AT04-12PB-SRGRY
* BLACK	AT04-12PB-SRBK
GREEN	AT04-12PB-SRGN
BROWN	AT04-12PB-SRBR

KEY-C CONFIGURATION	
COLOR	PART NUMBER
GREY	AT04-12PC-SRGRY
BLACK	AT04-12PC-SRBK
* GREEN	AT04-12PC-SRGN
BROWN	AT04-12PC-SRBR

KEY-D CONFIGURATION	
COLOR	PART NUMBER
GREY	AT04-12PD-SRGRY
BLACK	AT04-12PD-SRBK
GREEN	AT04-12PD-SRGN
* BROWN	AT04-12PD-SRBR

NOTE:

AN ASTERISKS (*) PLACED BEFORE THE COLOR DENOTES THE STANDARD MOLDED COLOR OF THE CONNECTORS SHOWN ABOVE. STRAIN RELIEF END CAPS ARE AVAILABLE IN BLACK ONLY.

OTHER COLORS SHOWN ARE AVAILABLE VIA SPECIAL ORDER.

TITLE: RECEPTACLE, 12 PIN, AT SERIES, KEYED, STRAIN RELIEF END CAP
DWG NO.: AT04-12PX-SRXXX
REV: A3
SH: 2
OF: 2

QUANTITY	PART NUMBER	DESCRIPTION	ITEM
MATERIALS LIST			
UNLESS OTHERWISE SPECIFIED 1) All dimensions are in metric (mm). 2) Tolerances are as follows: 1 PL DEC ±0.30 2 PL DEC ±0.15 3 PL DEC ±0.08 3) Note reference =		SIGNATURES DATE DRAWN: D.PARKS 11DEC13 CHECKED: ENGINEER: APPROVAL:	
MATERIAL SPECIFICATIONS:		CUSTOMER:	
PROCESS SPECIFICATIONS:		THIS DRAWING IS SUPPLIED FOR INFORMATION ONLY. DESIGN FEATURES, SPECIFICATIONS AND PERFORMANCE DATA SHOWN HEREON ARE THE PROPERTY OF THE AMPHENOL CORPORATION. NO RIGHTS OF REPRODUCTION ARE IMPLIED. ALL DIMENSIONS ARE SUBJECT TO NORMAL MANUFACTURING VARIATIONS.	
NEXT ASSY:		SCALE: NONE	
		 Sine Systems - www.amphenol-sine.com 44724 Morley Drive Clinton Township, MI 48036 RECEPTACLE, 12 PIN, AT SERIES, KEYED, STRAIN RELIEF END CAP SIZE: B C- DWG NO: AT04-12PX-SRXXX REVISION: A3 SHEET 2 OF 2	